

Grande® Wall

DESCRIPTION



The durable Grande® retaining wall comes in two architectural finishes: split face or smooth face.

The units that make up the Grande® wall are based on a unique tongue and groove interlocking technology. This provides greater flexibility, allowing you to build walls of virtually any height, with vertical setback or slope, relying on gravity or reinforced geogrid solutions.

BENEFITS:

- > Finish options: split or smooth
- > Quick and easy mechanical installation
- > Curved applications using Grande Wedge units
- > Ideal for large-scale retaining walls
- > Gravity or reinforced with geogrid installation, according to each project needs
- > No hardware required, thanks to its tongue and groove system
- > Several Grande Wall units suitable for different projects: standard wall unit, corner unit, step, capping and more



Since the design of a Grande Wall varies from one project to another, depending on the specifications of each, Permacon is able to provide a custom cross-section. For more information, please contact your Permacon representative or send an inquiry directly to our website.

GRANDE WALL - INSTALLATION

GRANDE WALL STANDARD UNITS

ISOMETRIC VIEW

375 STANDARD

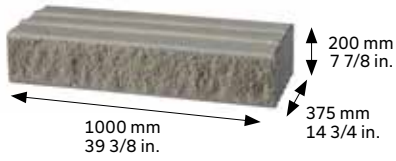

750 STANDARD

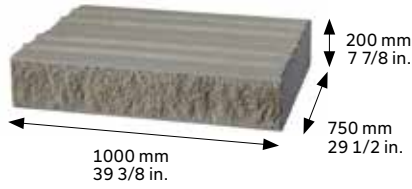

1125 STANDARD



TYPICAL ROW - TOP VIEW



ISOMETRIC VIEW

CORNER UNIT

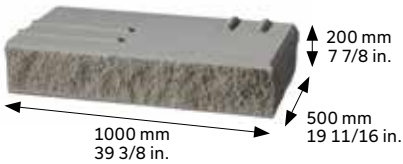

STEP 175

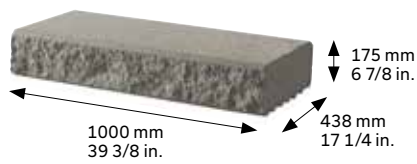

CAPPING 438

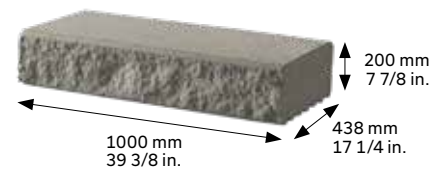

TYPICAL ROW - TOP VIEW

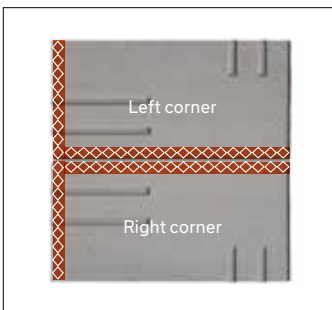

LEGENDE Smooth face  Split face 

GRANDE WALL - INSTALLATION

GRANDE SMOOTH WALL STANDARD UNITS

375 STANDARD

ISOMETRIC VIEW

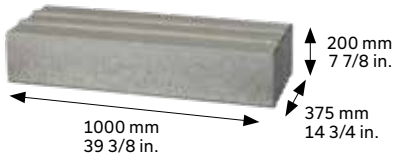

750 STANDARD



1125 STANDARD

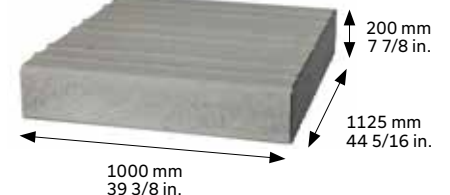

TYPICAL ROW - TOP VIEW



CORNER UNIT

ISOMETRIC VIEW

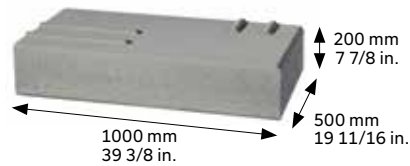

STEP 175

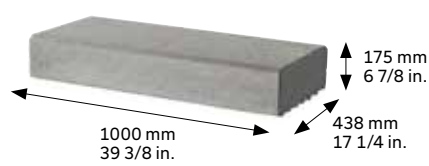

CAPPING 438

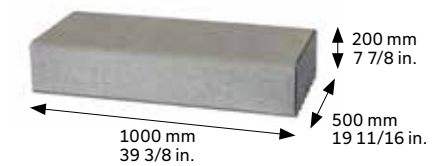

TYPICAL ROW - TOP VIEW

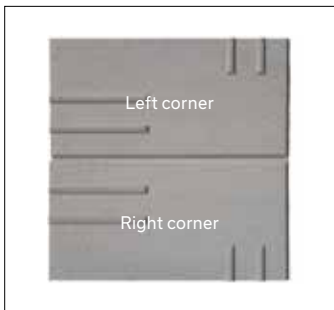

GRANDE WALL - INSTALLATION

GRANDE WALL WEDGE UNITS

STANDARD

CAPPING

Please note that Grande Wedge Wall is available in split face finish only, with one split face, and one smooth face on each unit.

ISOMETRIC VIEW

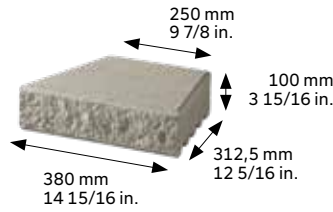
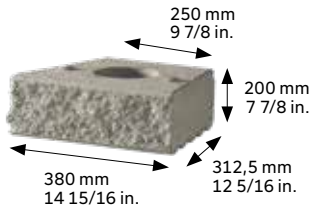

TYPICAL ROW - TOP VIEW

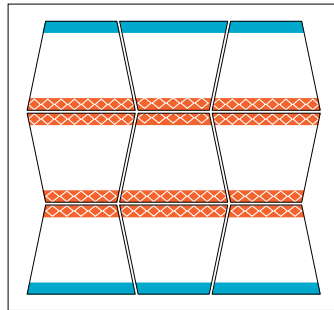
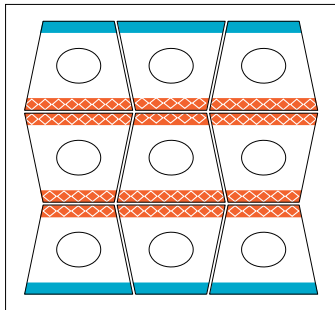

LEGENDE Smooth face  Split face 

BASIC PRINCIPLES

Grande 375 Standard Unit



Grande Corner Unit (right)

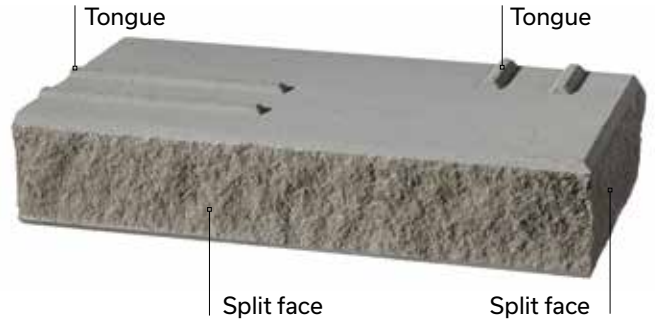

Grande Smooth 375 Standard Unit

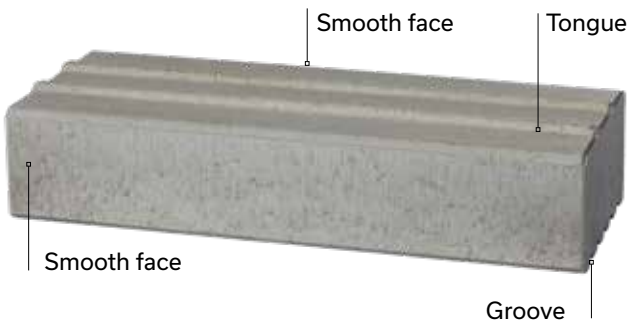

Grande Smooth Corner Unit (right)

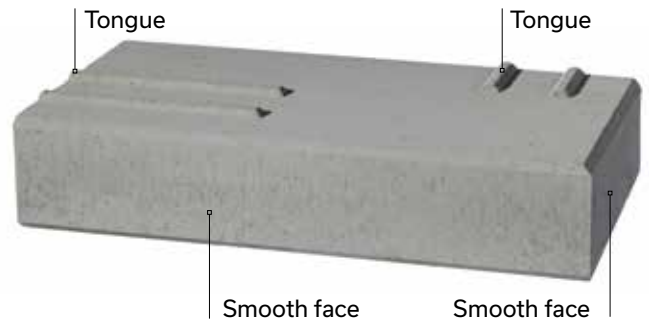

GRANDE WALL - INSTALLATION

LAYING PATTERN

RUNNING BOND PATTERN

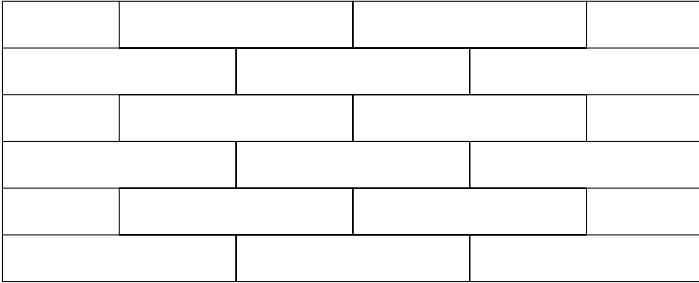

CREATING OUTER AND INNER CORNERS

It is recommended to always begin the construction of a retaining wall with a corner in order to avoid cuts and an alignment of vertical joints from one row to another.



ISOMETRIC VIEW - OUTER CORNER



ISOMETRIC VIEW - INNER CORNER

OUTER 90° CORNER

To create a 90° outer corner, follow these instructions:

- 1 - Begin the construction of a retaining wall with a corner in order to avoid cuts and an alignment of vertical joints from one row to another
- 2 - Alternate each row
- 3 - It is possible to start with a right corner or a left corner, as desired
- 4 - Use Techniseal concrete adhesive between each corner unit to ensure increased stability
- 5 - Units requiring cutting should be cut at least 125 mm - 5 in.
- 6 - Part of the corner units tongues should be chiseled off to allow interlocking with the upper rows

Plan view - Odd rows

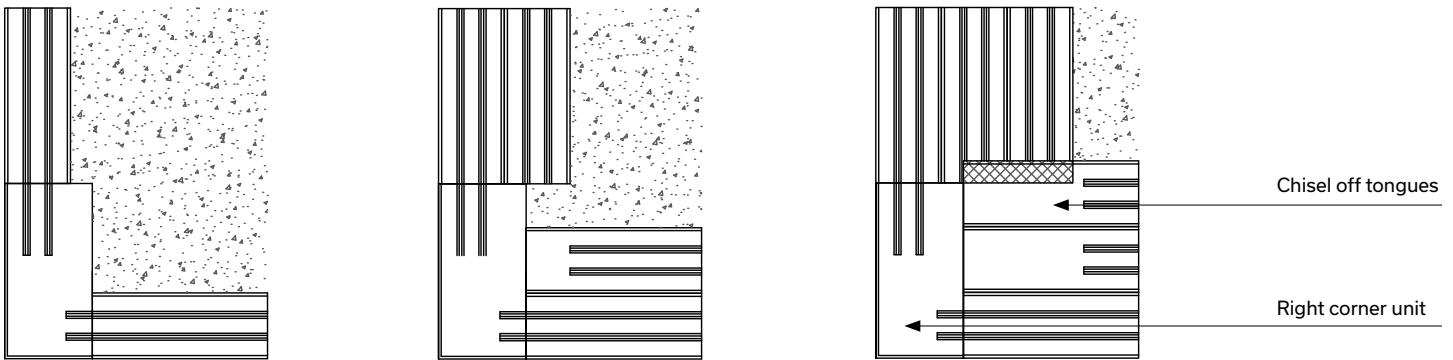

Plan view - Even rows

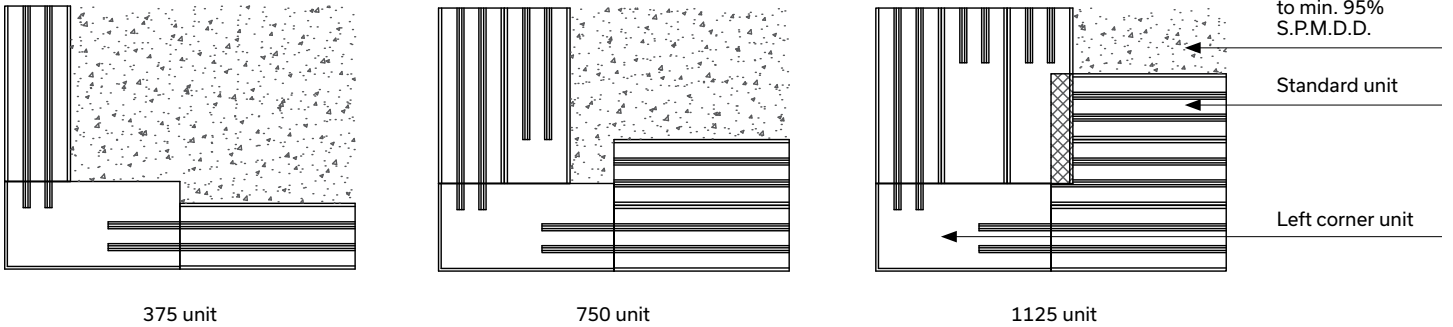

375 unit

750 unit

1125 unit

INNER 90° CORNER

To create a 90° inner corner, follow these instructions:

- 1 - Begin the construction of a retaining wall with a corner in order to avoid cuts and an alignment of vertical joints from one row to another
- 2 - Alternate each row
- 3 - It is possible to start with a right corner or a left corner, as desired
- 4 - Use Techniseal concrete adhesive between each corner unit to ensure increased stability
- 5 - Part of the corner units tongues should be chiseled off to allow interlocking with the upper rows

Plan view - Odd rows

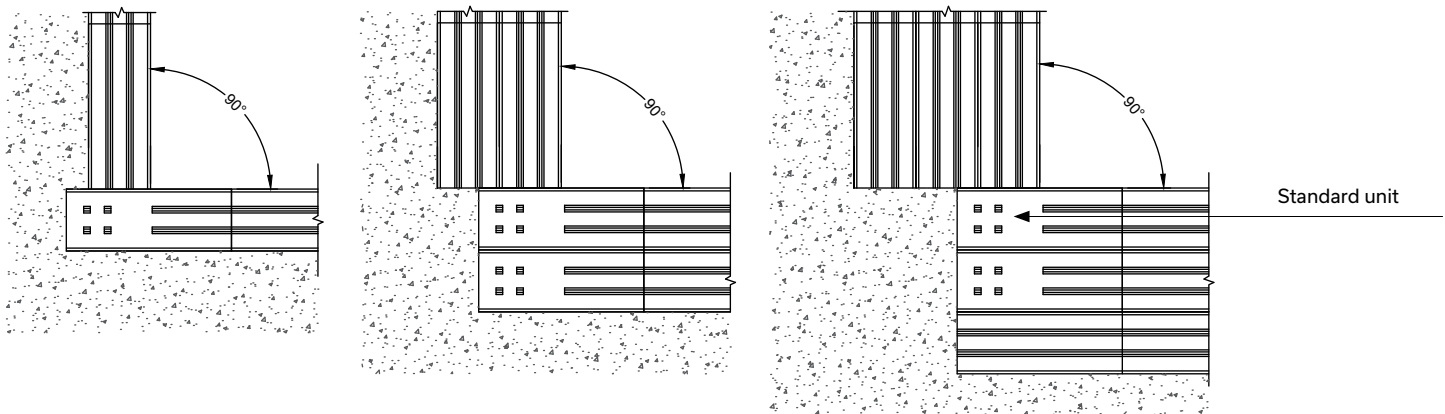

Plan view - Even rows

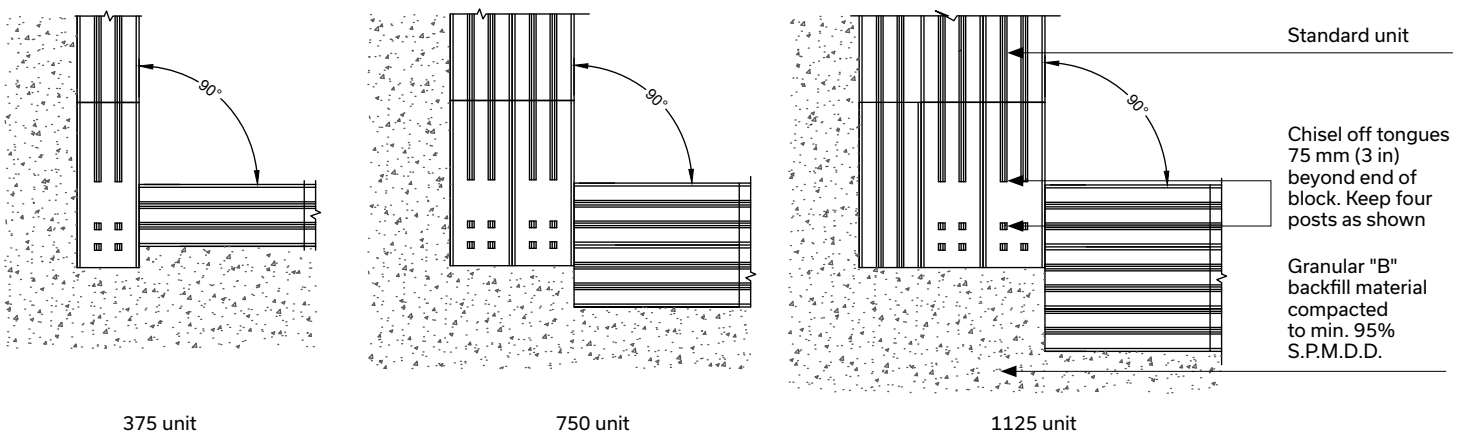

OUTER ANGLE CORNER

To create an outer angle corner, follow these instructions:

- 1 - Begin the construction of a retaining wall with a corner in order to avoid cuts and an alignment of vertical joints from one row to another
- 2 - Alternate each row
- 3 - It is possible to start with a right corner or a left corner, as desired
- 4 - Use Techniseal concrete adhesive between each corner unit to ensure increased stability
- 5 - Units requiring cutting should be cut in a way to have a unit of at least 125 mm - 5 in. in length
- 6 - Part of the corner units tongues should be chiseled off to allow interlocking with the upper rows

Plan view - Odd rows

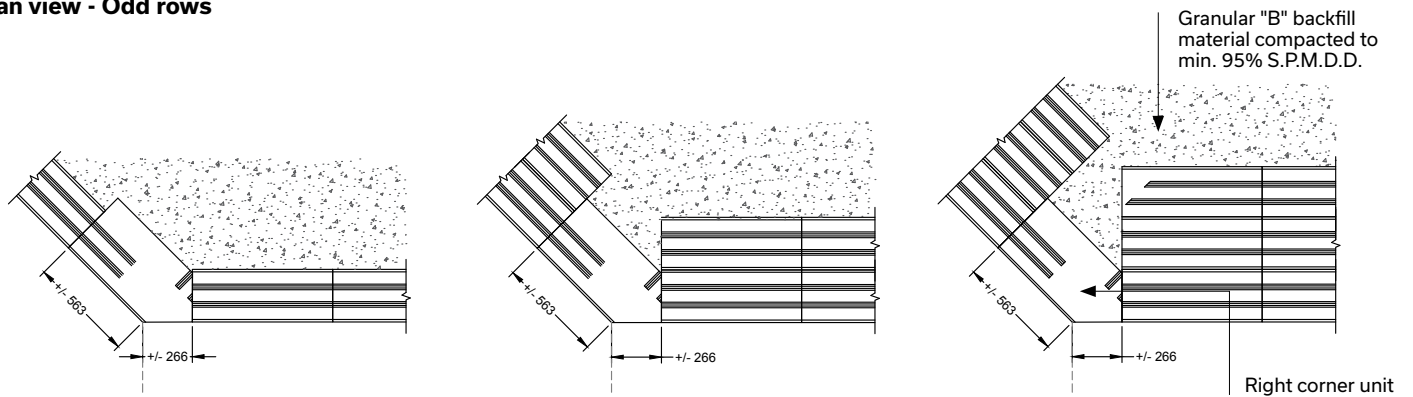

Plan view - Even rows

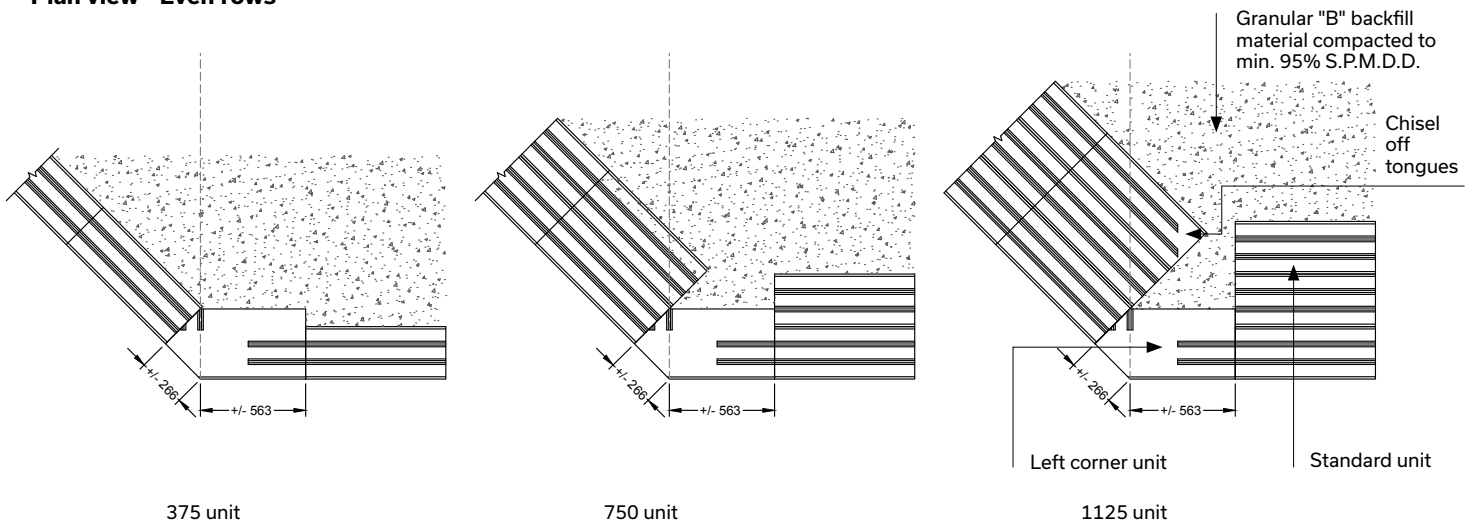

GRANDE WALL - INSTALLATION

INNER ANGLE CORNER

To create an inner angle corner, follow these instructions:

- 1 - Begin the construction of a retaining wall with a corner in order to avoid cuts and an alignment of vertical joints from one row to another
- 2 - Alternate each row
- 3 - It is possible to start with a right corner or a left corner, as desired
- 4 - Use Techniseal concrete adhesive between each corner unit to ensure increased stability
- 5 - Units requiring cutting should be cut in a way to have a unit of at least 500 mm - 20 in. in length

Plan view - Odd rows

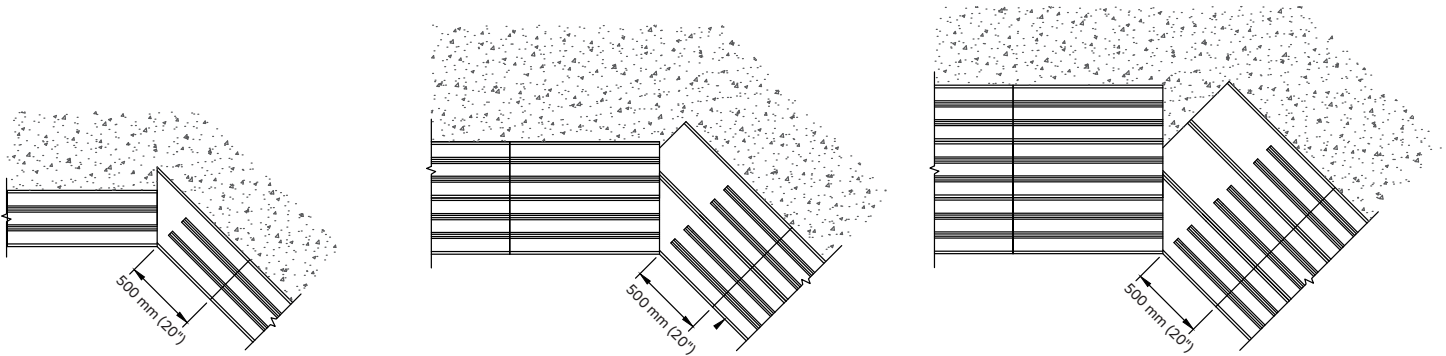

Plan view - Even rows

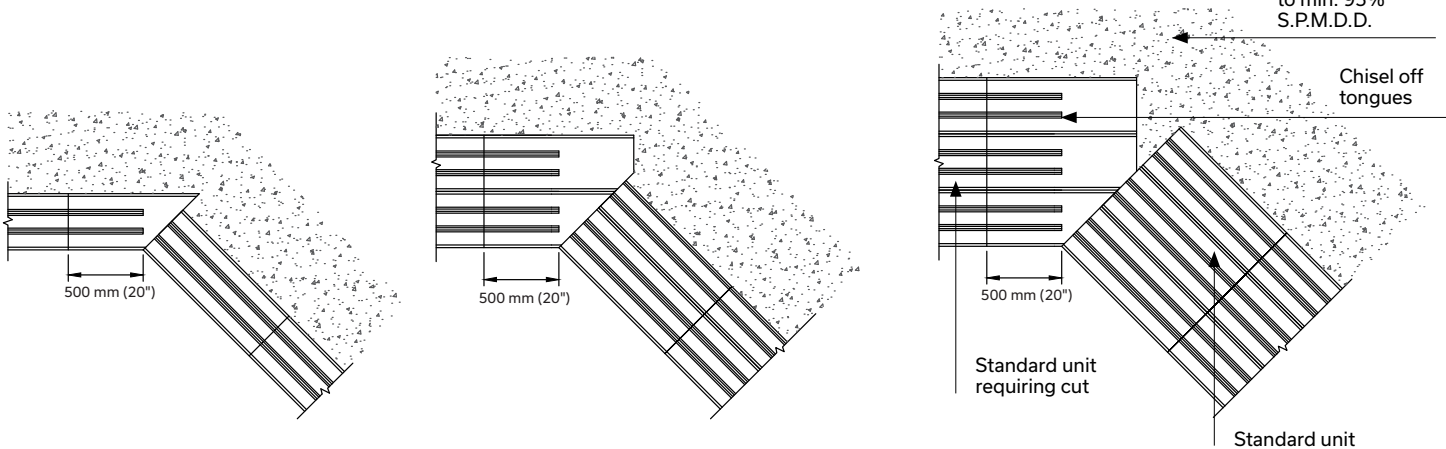

375 unit

750 unit

1125 unit

GEOGRID INSTALLATION

Instructions to follow for installing geogrids:

- > Follow the geogrid manufacturer instructions. Recommended type: Mirafi
- > Make sure the granular material is leveled with the geogrid once compacted
- > Place the geogrid by hand
- > Ensure the geogrid is oriented perpendicularly to the Grande Wall face
- > Pull tight on the geogrid while laying it down on the granular material to prevent wrinkles
- > Stake the geogrid down (on the granular material) before adding another layer of granular material

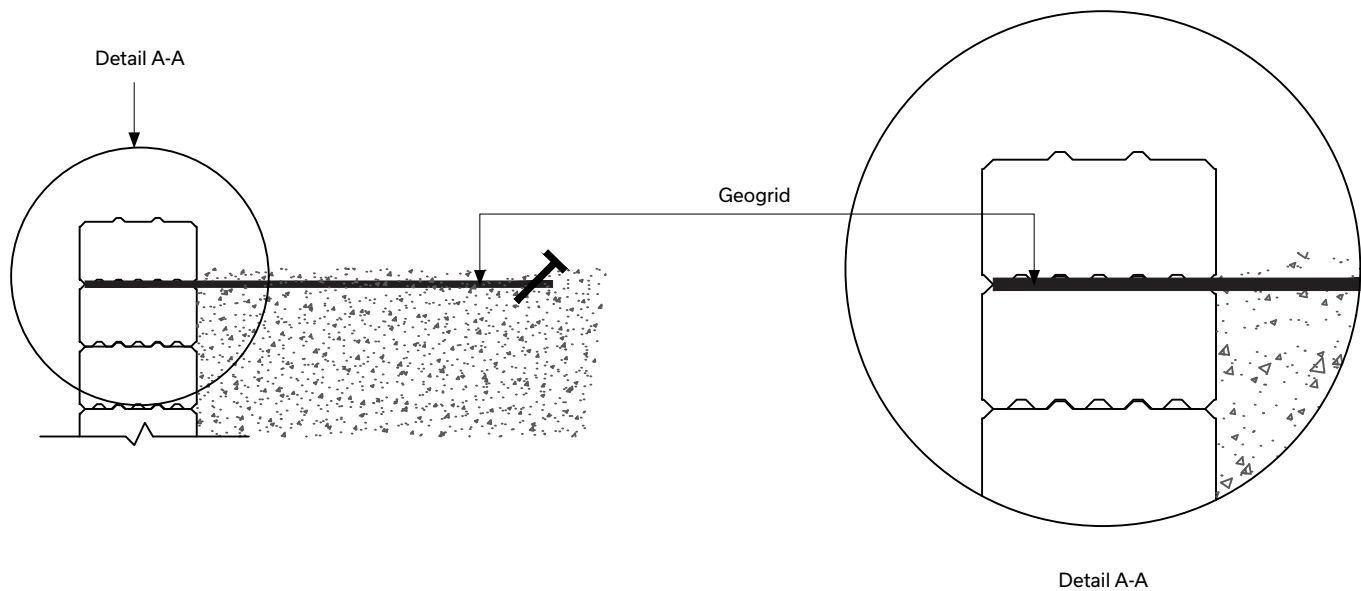

GRANDE WALL - INSTALLATION

CROSS-SECTION - GRANDE WALL 9° SETBACK GRAVITY 6 ROWS

Grande Wall 6 rows high (1.2 m or 3.9 ft.), including capping

- > 9° setback
- > Gravity
- > With 2.4 kPa surcharge
- > No slope behind the wall

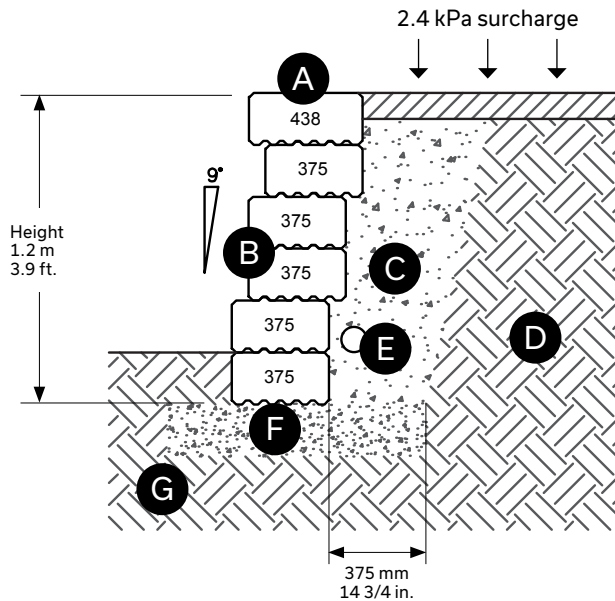

- Ⓐ Grande Wall - Capping 438 unit
- Ⓑ Grande Wall - 375 Standard: 5 rows high
- Ⓒ Granular "B" backfill material compacted to min. 95% S.P.M.D.D. Width: 375 mm - 14 3/4 in. behind the wall
- Ⓓ Undisturbed soil
- Ⓔ Perforated drain connected to services: 100 mm Ø - 4 in.
- Ⓕ Granular "A" material compacted to min. 98% S.P.M.D.D. Depth: 200 mm - 8 in. minimum
- Ⓖ Undisturbed soil or compacted granular foundation: 0 to 20 mm - 0 to 3/4 in. to obtain a min. bearing capacity of 150 kPa

Maximum gravity wall heights assume no slopes or surcharge behind the wall and that the wall retains sand or gravel ($\phi = 34$ degrees, $\gamma = 21 \text{ kN/m}^3$)

GRANDE WALL - INSTALLATION

CROSS-SECTION - GRANDE WALL 9° SETBACK GRAVITY 9 ROWS

Grande Wall 9 rows high (1.8 m or 5.9 ft.), including capping

- > 9° setback
- > Gravity
- > With 2.4 kPa surcharge
- > No slope behind the wall

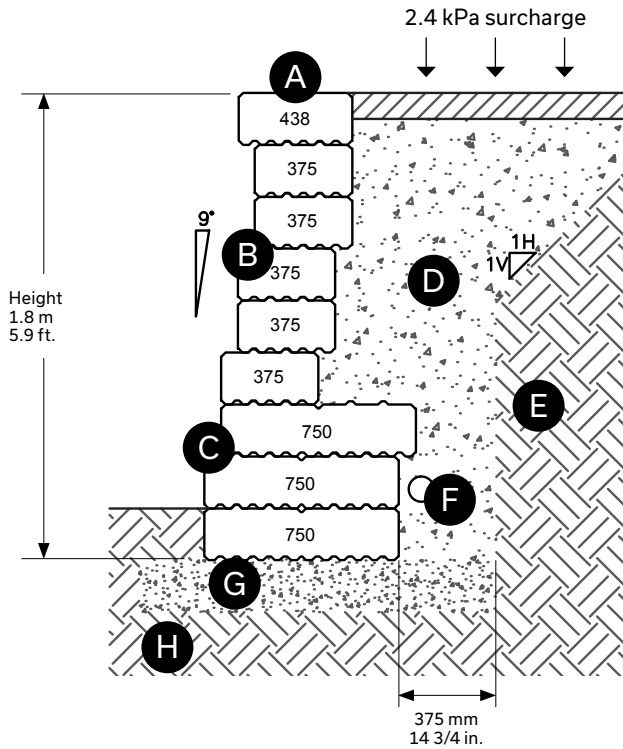

- Ⓐ Grande Wall – Capping 438 unit
- Ⓑ Grande Wall – 375 Standard: 5 rows high
- Ⓒ Grande Wall – 750 Standard: 3 rows high
- Ⓓ Granular "B" backfill material compacted to min. 95% S.P.M.D.D. Width: 375 mm - 14 3/4 in. behind the wall
- Ⓔ Undisturbed soil
- Ⓕ Perforated drain connected to services: 100 mm Ø - 4 in.
- Ⓖ Granular "A" material compacted to min. 98% S.P.M.D.D. Depth: 200 mm - 8 in. minimum
- Ⓗ Undisturbed soil or compacted granular foundation: 0 to 20 mm - 0 to 3/4 in. to obtain a min. bearing capacity of 150 kPa

Maximum gravity wall heights assume no slopes or surcharge behind the wall and that the wall retains sand or gravel ($\phi = 34$ degrees, $\gamma = 21 \text{ kN/m}^3$)

GRANDE WALL - INSTALLATION

CROSS-SECTION - GRANDE WALL 9° SETBACK GRAVITY 13 ROWS

Grande Wall 13 rows high (2.6 m or 8.53 ft.), including capping

- > 9° setback
- > Gravity
- > With 2.4 kPa surcharge
- > No slope behind the wall

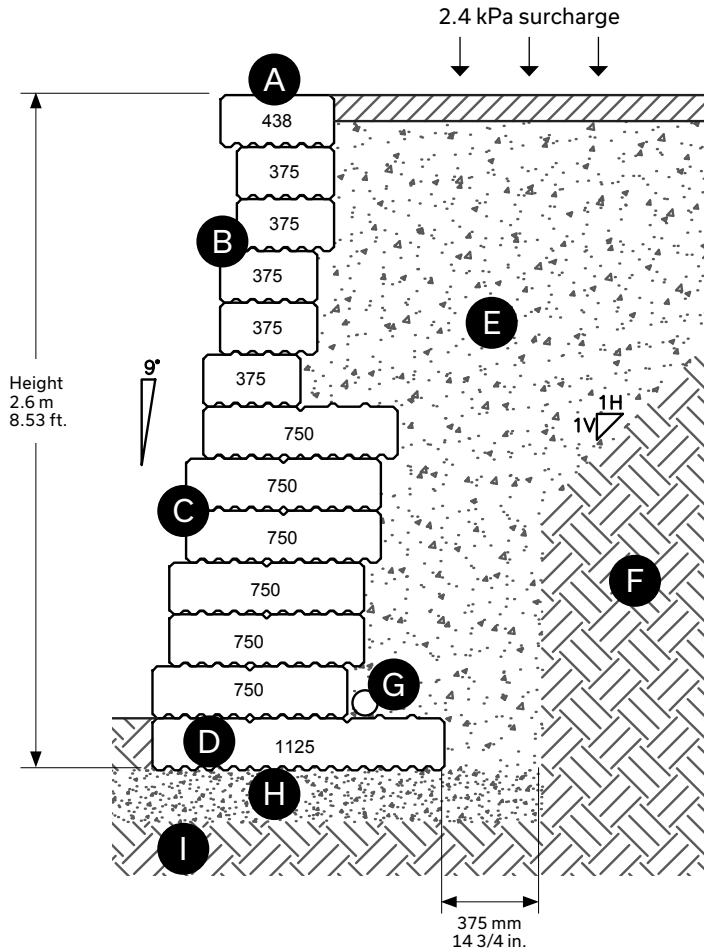

- A** Grande Wall – Capping 438 unit
- B** Grande Wall – 375 Standard: 5 rows high
- C** Grande Wall – 750 Standard: 6 rows high
- D** Grande Wall – 1125 Standard: 1 row high
- E** Granular "B" backfill material compacted to min. 95% S.P.M.D.D. - Width: 375 mm - 14 3/4 in. behind the wall
- F** Undisturbed soil
- G** Perforated drain connected to services: 100 mm Ø - 4 in.
- H** Granular "A" material compacted to min. 98% S.P.M.D.D. Depth: 200 mm - 8 in. minimum
- I** Undisturbed soil or compacted granular foundation: 0 to 20 mm - 0 to 3/4 in. to obtain a min. bearing capacity of 150 kPa

Maximum gravity wall heights assume no slopes or surcharge behind the wall and that the wall retains sand or gravel ($\phi = 34$ degrees, $\gamma = 21 \text{ kN/m}^3$)

GRANDE WALL - INSTALLATION

CROSS-SECTION - GRANDE WALL 9° SETBACK GRAVITY 15 ROWS

Grande Wall 15 rows high (3 m or 9.8 ft.), including capping

- > 9° setback
- > Gravity
- > With 2.4 kPa surcharge
- > No slope behind the wall

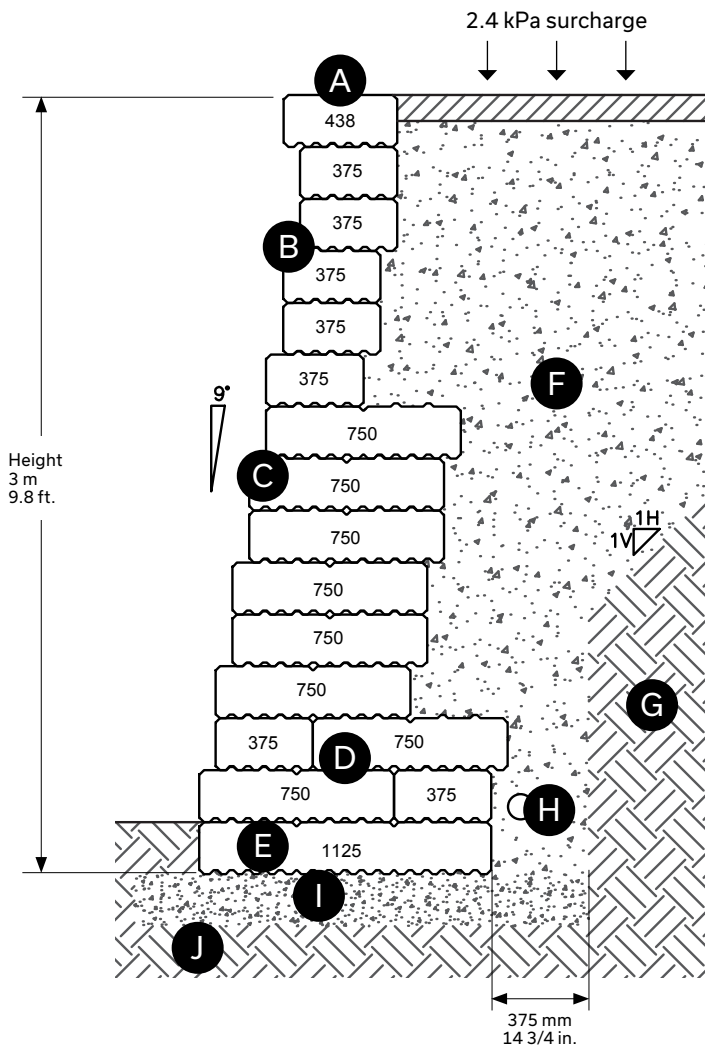

- Ⓐ Grande Wall – Capping 438 unit
- Ⓑ Grande Wall – 375 Standard: 5 rows high
- Ⓒ Grande Wall – 750 Standard: 6 rows high
- Ⓓ Grande Wall – 375 and 750 Standard: 2 rows high
- Ⓔ Grande Wall – 1125 Standard: 1 row high
- Ⓕ Granular "B" backfill material compacted to min. 95% S.P.M.D.D. - Width: 375 mm - 14 3/4 in. behind the wall
- Ⓖ Undisturbed soil
- Ⓗ Perforated drain connected to services: 100 mm Ø - 4 in.
- Ⓘ Granular "A" material compacted to min. 98% S.P.M.D.D. Depth: 200 mm - 8 in. minimum
- Ⓚ Undisturbed soil or compacted granular foundation: 0 to 20 mm - 0 to 3/4 in. to obtain a min. bearing capacity of 150 kPa

Maximum gravity wall heights assume no slopes or surcharge behind the wall and that the wall retains sand or gravel ($\phi = 34$ degrees, $\gamma = 21 \text{ kN/m}^3$)

GRANDE WALL - INSTALLATION

CROSS-SECTION - GRANDE WEDGE WALL 9° SETBACK GRAVITY 5 ROWS

Grande Wedge Wall 5 rows high (0.9 m or 2.95 ft.), including capping

- > 9° setback
- > Gravity
- > With 2.4 kPa surcharge
- > No slope behind the wall
- > Fill the cavities of the Grande Wedge units with clean stone

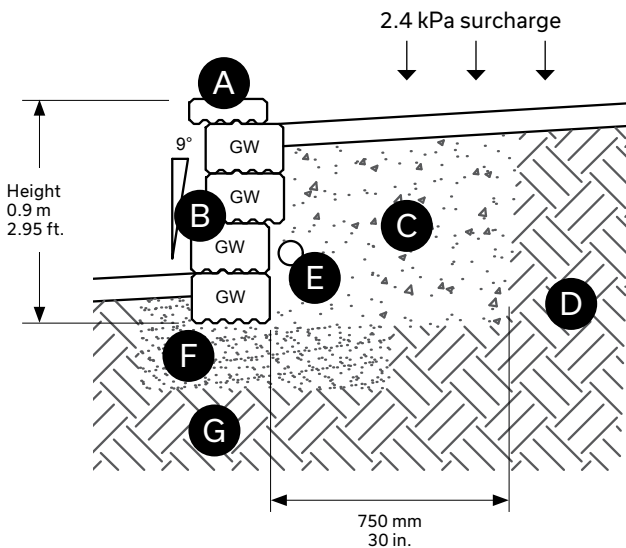

- Ⓐ Grande Wall – Capping 438 unit
- Ⓑ Grande Wall – Wedge Standard: 4 rows high
- Ⓒ Granular "B" backfill material compacted to min. 95% S.P.M.D.D. Width: 750 mm - 29 1/2 in. behind the wall
- Ⓓ Undisturbed soil
- Ⓔ Perforated drain connected to services: 100 mm Ø - 4 in.
- Ⓕ Granular "A" material compacted to min. 98% S.P.M.D.D. Depth: 200 mm - 8 in. minimum
- Ⓖ Undisturbed soil or compacted granular foundation: 0 to 20 mm - 0 to 3/4 in. to obtain a min. bearing capacity of 150 kPa

Grande Wedge Wall units are required to create curves with Grande Wall. Permacon is able to provide you with a customized standard cut. For more information, please contact your Permacon representative or send an inquiry directly to our website.

Maximum gravity wall heights assume no slopes or surcharge behind the wall and that the wall retains sand or gravel ($\phi = 34$ degrees, $\gamma = 21 \text{ kN/m}^3$)

GRANDE WALL - INSTALLATION

CROSS-SECTION - GRANDE WALL 17° SETBACK GRAVITY 8 ROWS

Grande Wall 8 rows high (1.6 m or 5.2 ft.), including capping

- > 17° setback
- > Gravity
- > With 2.4 kPa surcharge
- > No slope behind the wall

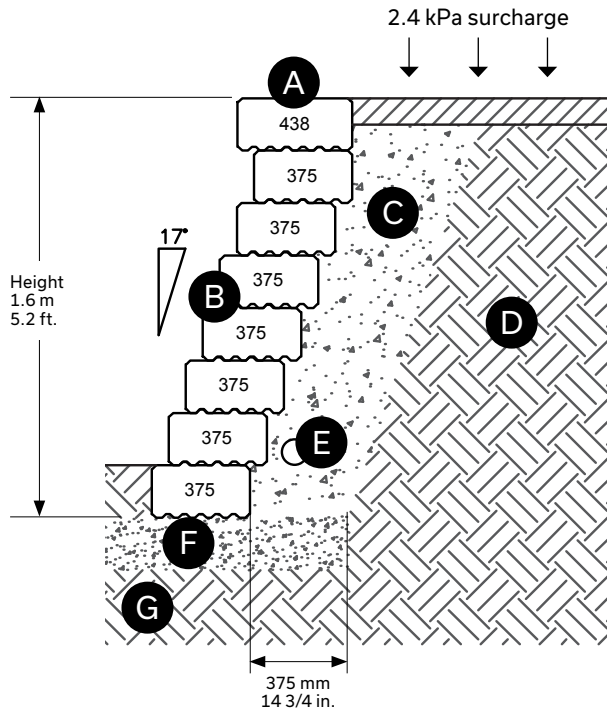

- Ⓐ Grande Wall – Capping 438 unit
- Ⓑ Grande Wall – 375 Standard: 7 rows high
- Ⓒ Granular "B" backfill material compacted to min. 95% S.P.M.D.D. Width: 375 mm - 14 3/4 in. behind the wall
- Ⓓ Undisturbed soil
- Ⓔ Perforated drain connected to services: 100 mm Ø - 4 in.
- Ⓕ Granular "A" material compacted to min. 98% S.P.M.D.D. Depth: 200 mm - 8 in. minimum
- Ⓖ Undisturbed soil or compacted granular foundation: 0 to 20 mm - 0 to 3/4 in. to obtain a min. bearing capacity of 150 kPa

Maximum gravity wall heights assume no slopes or surcharge behind the wall and that the wall retains sand or gravel ($\phi = 34$ degrees, $\gamma = 21 \text{ kN/m}^3$)

GRANDE WALL - INSTALLATION

CROSS-SECTION - GRANDE WALL 17° SETBACK GRAVITY 10 ROWS

Grande Wall 10 rows high (2 m or 6.6 ft.), including capping

- > 17° setback
- > Gravity
- > With 2.4 kPa surcharge
- > No slope behind the wall

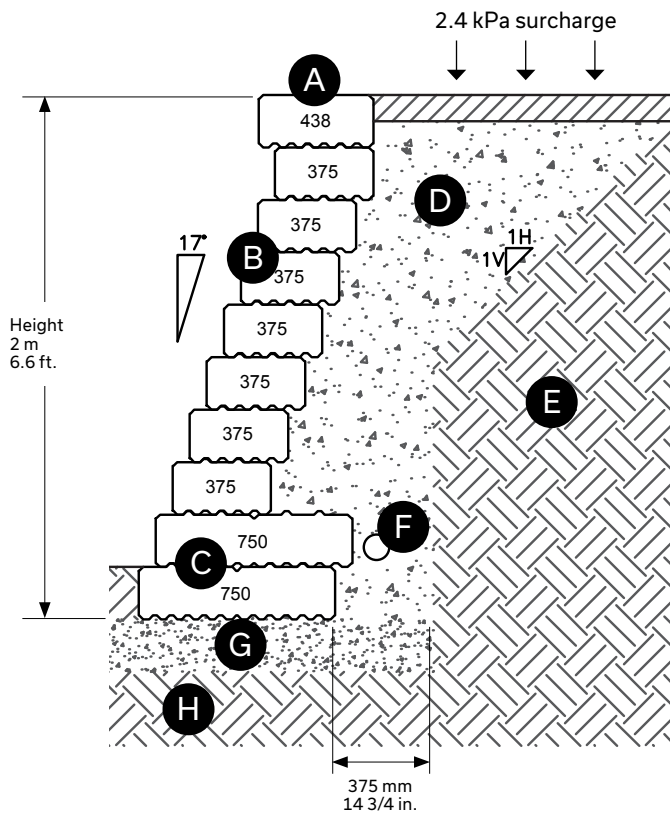

- A Grande Wall - Capping 438 unit
- B Grande Wall - 375 Standard: 7 rows high
- C Grande Wall - 750 Standard: 2 rows high
- D Granular "B" backfill material compacted to min. 95% S.P.M.D.D. Width: 375 mm - 14 3/4 in. behind the wall
- E Undisturbed soil
- F Perforated drain connected to services: 100 mm Ø - 4 in.
- G Granular "A" material compacted to min. 98% S.P.M.D.D. Depth: 200 mm - 8 in. minimum
- H Undisturbed soil or compacted granular foundation: 0 to 20 mm - 0 to 3/4 in. to obtain a min. bearing capacity of 150 kPa

Maximum gravity wall heights assume no slopes or surcharge behind the wall and that the wall retains sand or gravel ($\phi = 34$ degrees, $\gamma = 21 \text{ kN/m}^3$)

GRANDE WALL - INSTALLATION

CROSS-SECTION - GRANDE WALL 17° SETBACK GRAVITY 12 ROWS

Grande Wall 12 rows high (2.4 m or 7.9 ft.), including capping

- > 17° setback
- > Gravity
- > With 2.4 kPa surcharge
- > No slope behind the wall

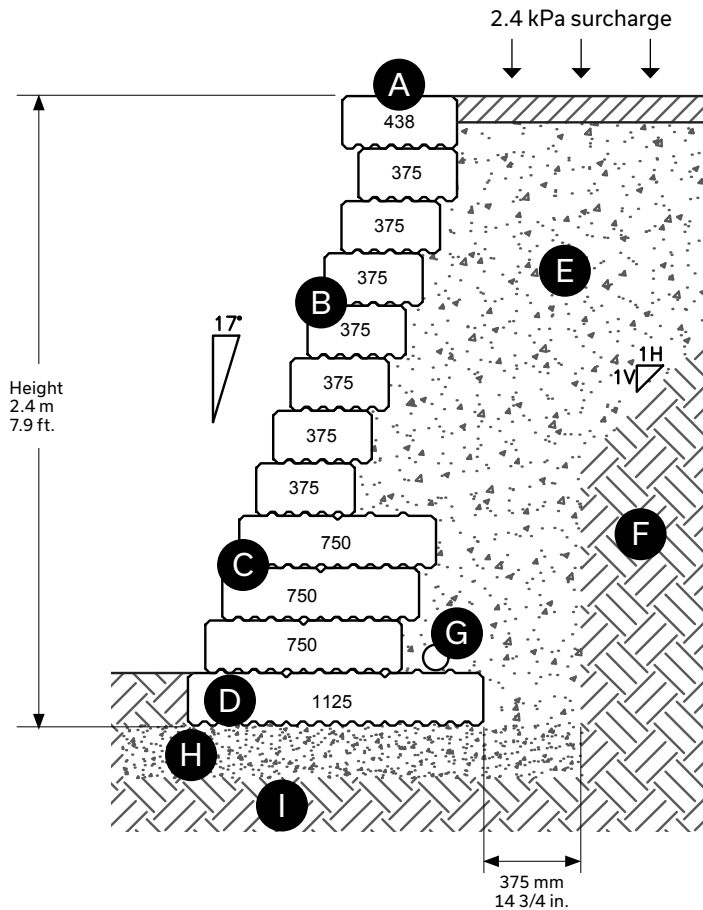

- A** Grande Wall – Capping 438 unit
- B** Grande Wall – 375 Standard: 7 rows high
- C** Grande Wall – 750 Standard: 3 rows high
- D** Grande Wall – 1125 Standard: 1 row high
- E** Granular "B" backfill material compacted to min. 95% S.P.M.D.D. - Width: 375 mm - 14 3/4 in. behind the wall
- F** Undisturbed soil
- G** Perforated drain connected to services: 100 mm Ø - 4 in.
- H** Granular "A" material compacted to min. 98% S.P.M.D.D. Depth: 200 mm - 8 in. minimum
- I** Undisturbed soil or compacted granular foundation: 0 to 20 mm - 0 to 3/4 in. to obtain a min. bearing capacity of 150 kPa

Maximum gravity wall heights assume no slopes or surcharge behind the wall and that the wall retains sand or gravel ($\phi = 34$ degrees, $\gamma = 21 \text{ kN/m}^3$)

GRANDE WALL - INSTALLATION

CROSS-SECTION - GRANDE WEDGE WALL 17° SETBACK GRAVITY 7 ROWS

Grande Wedge Wall 7 rows high (1.3 m or 4.27 ft.), including capping

- > 17° setback
- > Gravity
- > With 2.4 kPa surcharge
- > No slope behind the wall
- > Fill the cavities of the Grande Wedge units with clean stone

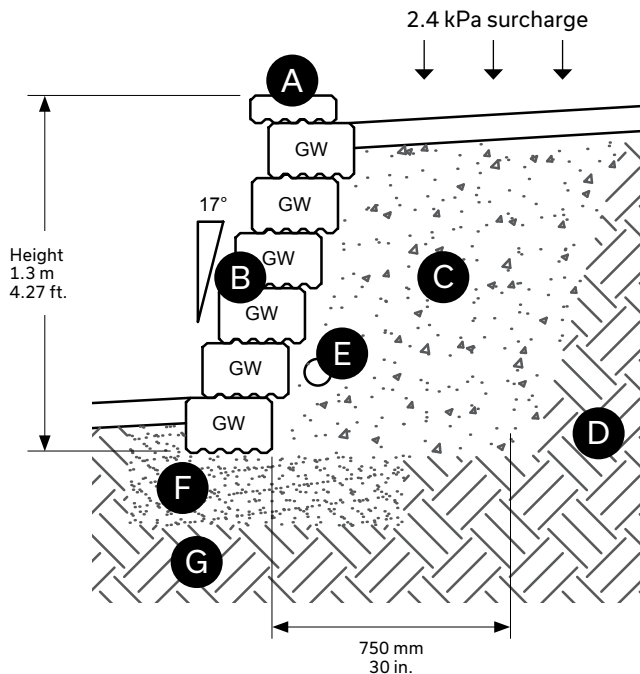

- A** Grande Wall – Capping 438 unit
- B** Grande Wall – Wedge Standard: 6 rows high
- C** Granular "B" backfill material compacted to min. 95% S.P.M.D.D. Width: 750 mm - 29 1/2 in. behind the wall
- D** Undisturbed soil
- E** Perforated drain connected to services: 100 mm Ø - 4 in.
- F** Granular "A" material compacted to min. 98% S.P.M.D.D. Depth: 200 mm - 8 in. minimum
- G** Undisturbed soil or compacted granular foundation: 0 to 20 mm - 0 to 3/4 in. to obtain a min. bearing capacity of 150 kPa

Grande Wedge Wall units are required to create curves with Grande Wall. Permacon is able to provide you with a customized standard cut. For more information, please contact your Permacon representative or send an inquiry directly to our website.

Maximum gravity wall heights assume no slopes or surcharge behind the wall and that the wall retains sand or gravel ($\phi = 34$ degrees, $\gamma = 21 \text{ kN/m}^3$)

GRANDE WALL - INSTALLATION

CROSS-SECTION - GRANDE WALL STRAIGHT GRAVITY 5 ROWS

Grande Wall 5 rows high (1 m or 3.28 ft.), including capping

- > Straight
- > Gravity
- > With 2.4 kPa surcharge
- > No slope behind the wall

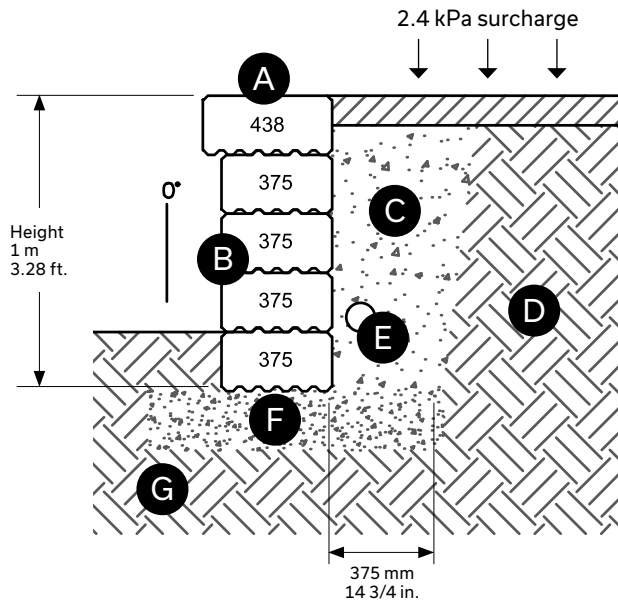

- Ⓐ Grande Wall – Capping 438 unit
- Ⓑ Grande Wall – 375 Standard: 4 rows high
- Ⓒ Granular "B" backfill material compacted to min. 95% S.P.M.D.D. Width: 375 mm - 14 3/4 in. behind the wall
- Ⓓ Undisturbed soil
- Ⓔ Perforated drain connected to services: 100 mm Ø - 4 in.
- Ⓕ Granular "A" material compacted to min. 98% S.P.M.D.D. Depth: 200 mm - 8 in. minimum
- Ⓖ Undisturbed soil or compacted granular foundation: 0 to 20 mm - 0 to 3/4 in. to obtain a min. bearing capacity of 150 kPa

Maximum gravity wall heights assume no slopes or surcharge behind the wall and that the wall retains sand or gravel ($\phi = 34$ degrees, $\gamma = 21 \text{ kN/m}^3$)

GRANDE WALL - INSTALLATION

CROSS-SECTION - GRANDE WALL STRAIGHT GRAVITY 8 ROWS

Grande Wall 5 rows high (1.6 m or 5.2 ft.), including capping

- > Straight
- > Gravity
- > With 2.4 kPa surcharge
- > No slope behind the wall

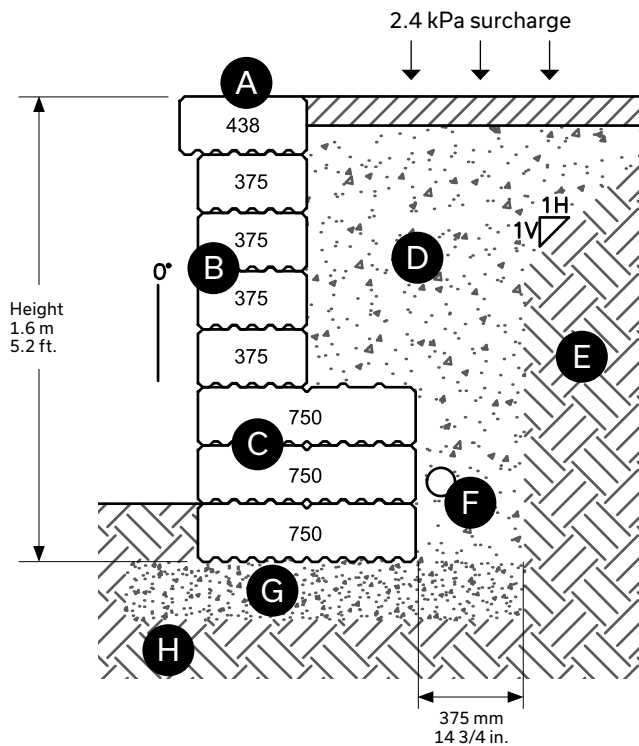

- Ⓐ Grande Wall - Capping 438 unit
- Ⓑ Grande Wall - 375 Standard: 4 rows high
- Ⓒ Grande Wall - 750 Standard: 3 rows high
- Ⓓ Granular "B" backfill material compacted to min. 95% S.P.M.D.D. Width: 375 mm - 14 3/4 in. behind the wall
- Ⓔ Undisturbed soil
- Ⓕ Perforated drain connected to services: 100 mm Ø - 4 in.
- Ⓖ Granular "A" material compacted to min. 98% S.P.M.D.D. Depth: 200 mm - 8 in. minimum
- Ⓗ Undisturbed soil or compacted granular foundation: 0 to 20 mm - 0 to 3/4 in. to obtain a min. bearing capacity of 150 kPa

Maximum gravity wall heights assume no slopes or surcharge behind the wall and that the wall retains sand or gravel ($\phi = 34$ degrees, $\gamma = 21 \text{ kN/m}^3$)

GRANDE WALL - INSTALLATION

CROSS-SECTION - GRANDE WALL STRAIGHT GRAVITY 12 ROWS

Grande Wall 12 rows high (2.4 m or 7.9 ft.), including capping

- > Straight
- > Gravity
- > With 2.4 kPa surcharge
- > No slope behind the wall

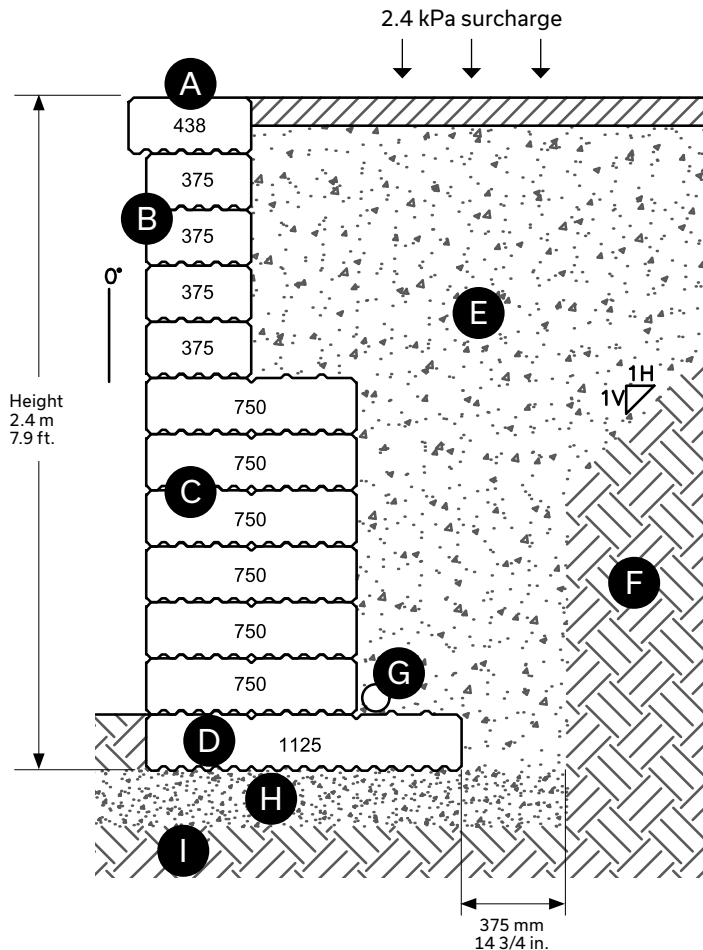

- A** Grande Wall – Capping 438 unit
- B** Grande Wall – 375 Standard: 4 rows high
- C** Grande Wall – 750 Standard: 6 rows high
- D** Grande Wall – 1125 Standard: 1 row high
- E** Granular "B" backfill material compacted to min. 95% S.P.M.D.D. - Width: 375 mm - 14 3/4 in. behind the wall
- F** Undisturbed soil
- G** Perforated drain connected to services: 100 mm Ø - 4 in.
- H** Granular "A" material compacted to min. 98% S.P.M.D.D. Depth: 200 mm - 8 in. minimum
- I** Undisturbed soil or compacted granular foundation: 0 to 20 mm - 0 to 3/4 in. to obtain a min. bearing capacity of 150 kPa

Maximum gravity wall heights assume no slopes or surcharge behind the wall and that the wall retains sand or gravel ($\phi = 34$ degrees, $\gamma = 21 \text{ kN/m}^3$)

GRANDE WALL - INSTALLATION

CROSS-SECTION - GRANDE WALL STRAIGHT GRAVITY 15 ROWS

Grande Wall 15 rows high (3 m or 9.8 ft.), including capping

- > Straight
- > Gravity
- > With 2.4 kPa surcharge
- > No slope behind the wall

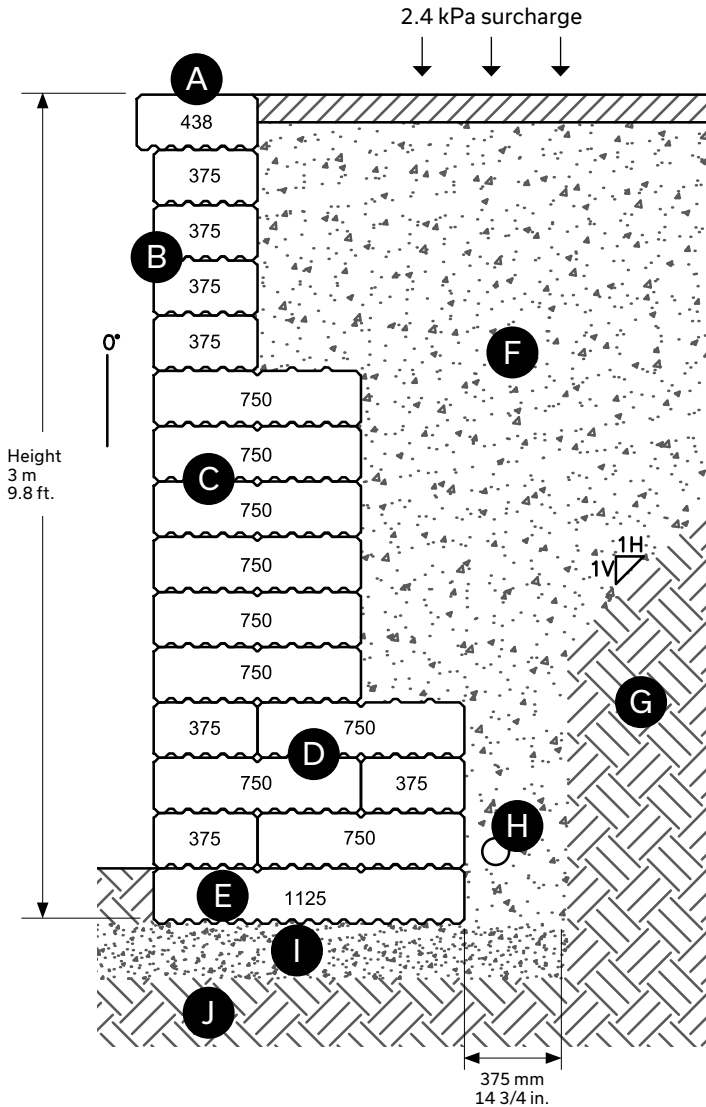

- Ⓐ Grande Wall – Capping 438 unit
- Ⓑ Grande Wall – 375 Standard: 4 rows high
- Ⓒ Grande Wall – 750 Standard: 6 rows high
- Ⓓ Grande Wall – 375 and 750 Standard: 3 rows high
- Ⓔ Grande Wall – 1125 Standard: 1 row high
- Ⓕ Granular "B" backfill material compacted to min. 95% S.P.M.D.D. - Width: 375 mm - 14 3/4 in. behind the wall
- Ⓖ Undisturbed soil
- Ⓗ Perforated drain connected to services: 100 mm Ø - 4 in.
- Ⓘ Granular "A" material compacted to min. 98% S.P.M.D.D. Depth: 200 mm - 8 in. minimum
- Ⓚ Undisturbed soil or compacted granular foundation: 0 to 20 mm - 0 to 3/4 in. to obtain a min. bearing capacity of 150 kPa

Maximum gravity wall heights assume no slopes or surcharge behind the wall and that the wall retains sand or gravel ($\phi = 34$ degrees, $\gamma = 21 \text{ kN/m}^3$)

GRANDE WALL - INSTALLATION

CROSS-SECTION - GRANDE WEDGE WALL STRAIGHT GRAVITY 4 ROWS

Grande Wedge Wall 4 rows high (0.7 m or 2.3 ft.), including capping

- > Straight
- > Gravity
- > With 2.4 kPa surcharge
- > No slope behind the wall
- > Fill the cavities of the Grande Wedge units with clean stone

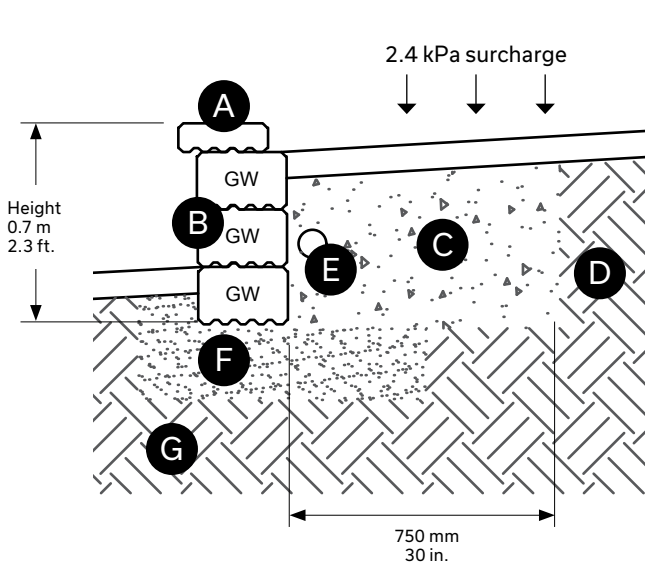

- Ⓐ Grande Wall - Capping 438 unit
- Ⓑ Grande Wall - Wedge Standard: 3 rows high
- Ⓒ Granular "B" backfill material compacted to min. 95% S.P.M.D.D. - Width: 750 mm - 29 1/2 in. behind the wall
- Ⓓ Undisturbed soil
- Ⓔ Perforated drain connected to services: 100 mm Ø - 4 in.
- Ⓕ Granular "A" material compacted to min. 98% S.P.M.D.D. Depth: 200 mm - 8 in. minimum
- Ⓖ Undisturbed soil or compacted granular foundation: 0 to 20 mm - 0 to 3/4 in. to obtain a min. bearing capacity of 150 kPa

Grande Wedge Wall units are required to create curves with Grande Wall. Permacon is able to provide you with a customized standard cut. For more information, please contact your Permacon representative or send an inquiry directly to our website.

Maximum gravity wall heights assume no slopes or surcharge behind the wall and that the wall retains sand or gravel ($\phi = 34$ degrees, $\gamma = 21 \text{ kN/m}^3$)

GRANDE WALL - INSTALLATION

CROSS-SECTION - GRANDE WALL 9° SETBACK REINFORCED 9 ROWS

Grande Wall 9 rows high (1.8 m or 5.9 ft), including capping

- > 9° setback
- > Reinforced with geogrid. Recommended geogrid: Miragrid 3XT
- > With 2.4 kPa surcharge
- > No slope behind the wall

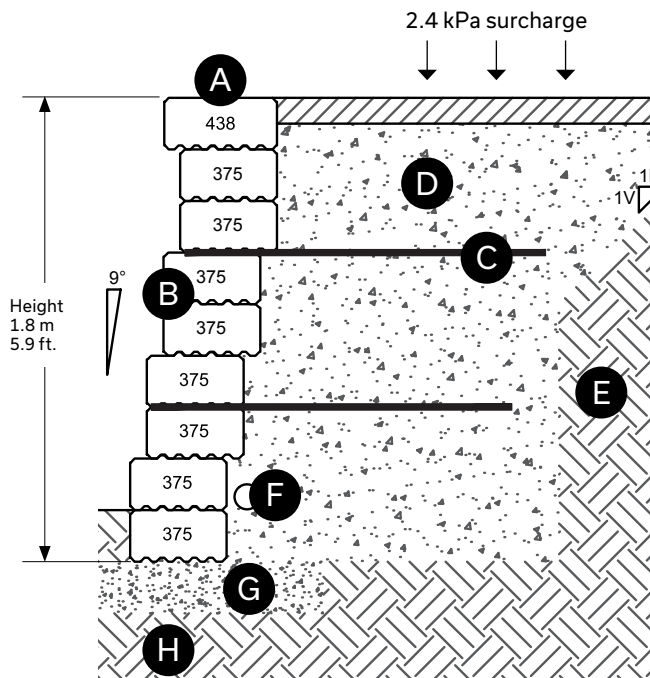

- Ⓐ Grande Wall – Capping 438 unit
- Ⓑ Grande Wall – 375 Standard: 8 rows high
- Ⓒ Geogrid: 1.4 m - 4.6 ft. length
- Ⓓ Granular "B" backfill material compacted to min. 95% S.P.M.D.D. Width: 375 mm - 14 3/4 in. behind the wall
- Ⓔ Undisturbed soil
- Ⓕ Perforated drain connected to services: 100 mm Ø - 4 in.
- Ⓖ Granular "A" material compacted to min. 98% S.P.M.D.D. Depth: 200 mm - 8 in. minimum
- Ⓗ Undisturbed soil or compacted granular foundation: 0 to 20 mm - 0 to 3/4 in. to obtain a min. bearing capacity of 150 kPa

Maximum gravity wall heights assume no slopes or surcharge behind the wall and that the wall retains sand or gravel ($\phi = 34$ degrees, $\gamma = 21 \text{ kN/m}^3$)

GRANDE WALL - INSTALLATION

CROSS-SECTION - GRANDE WALL 9° SETBACK REINFORCED 12 ROWS

Grande Wall 12 rows high (2.4 m or 7.9 ft), including capping

- > 9° setback
- > Reinforced with geogrid. Recommended geogrid: Miragrid 3XT
- > With 2.4 kPa surcharge
- > No slope behind the wall

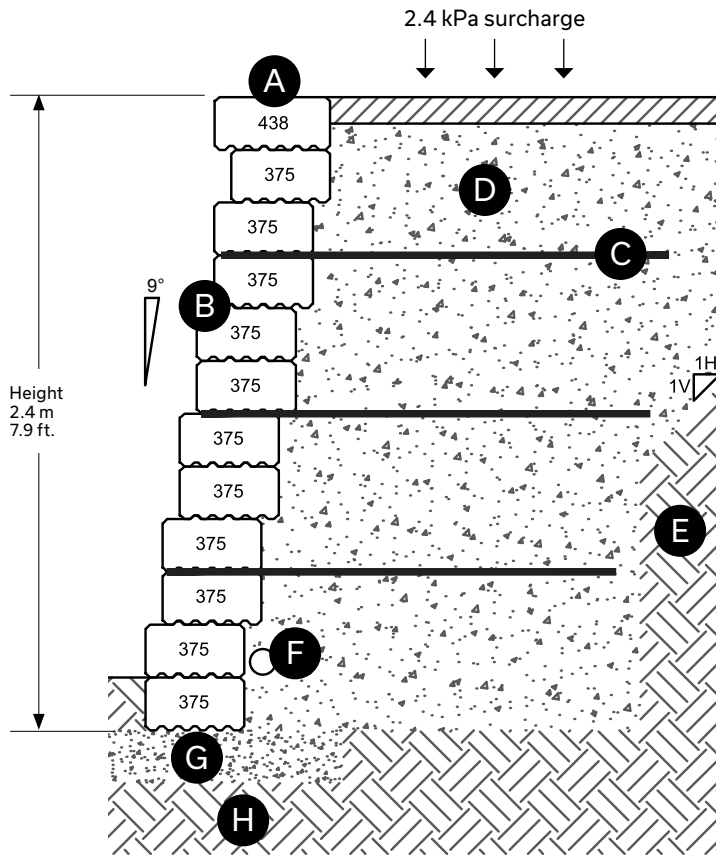

- A** Grande Wall – Capping 438 unit
- B** Grande Wall – 375 Standard: 11 rows high
- C** Geogrid: 1.7 m - 5.6 ft. minimum length
- D** Granular "B" backfill material compacted to min. 95% S.P.M.D.D. - Width: 375 mm - 14 3/4 in. behind the wall
- E** Undisturbed soil
- F** Perforated drain connected to services: 100 mm Ø - 4 in.
- G** Granular "A" material compacted to min. 98% S.P.M.D.D. Depth: 200 mm - 8 in. minimum
- H** Undisturbed soil or compacted granular foundation: 0 to 20 mm - 0 to 3/4 in. to obtain a min. bearing capacity of 150 kPa

Maximum gravity wall heights assume no slopes or surcharge behind the wall and that the wall retains sand or gravel ($\phi = 34$ degrees, $\gamma = 21 \text{ kN/m}^3$)

GRANDE WALL - INSTALLATION

CROSS-SECTION - GRANDE WALL 9° SETBACK REINFORCED 15 ROWS

Grande Wall 15 rows high (3 m or 9.8 ft), including capping

- > 9° setback
- > Reinforced with geogrid. Recommended geogrid: Miragrid 3XT
- > With 2.4 kPa surcharge
- > No slope behind the wall

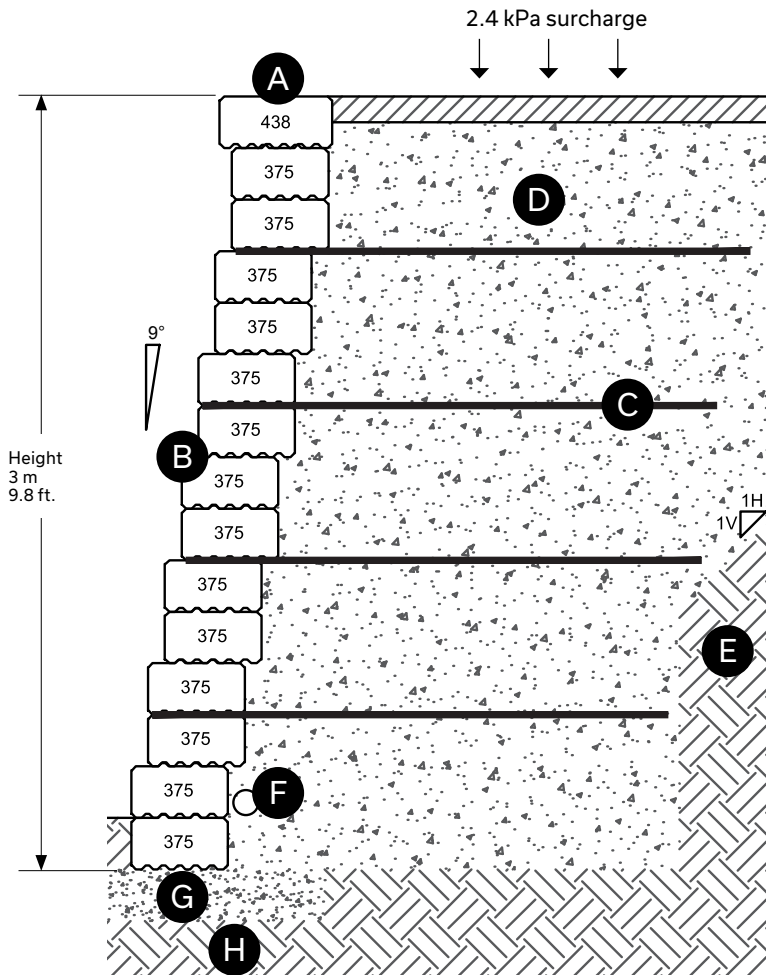

- A** Grande Wall – Capping 438 unit
- B** Grande Wall – 375 Standard: 14 rows high
- C** Geogrid: 2 m - 6,6 ft. minimum length
- D** Granular "B" backfill material compacted to min. 95% S.P.M.D.D. - Width: 375 mm - 14 3/4 in. behind the wall
- E** Undisturbed soil
- F** Perforated drain connected to services: 100 mm Ø - 4 in.
- G** Granular "A" material compacted to min. 98% S.P.M.D.D. - Depth: 200 mm - 8 in. minimum
- H** Undisturbed soil or compacted granular foundation: 0 to 20 mm - 0 to 3/4 in. to obtain a min. bearing capacity of 150 kPa

Maximum gravity wall heights assume no slopes or surcharge behind the wall and that the wall retains sand or gravel ($\phi = 34$ degrees, $\gamma = 21 \text{ kN/m}^3$)

GRANDE WALL - INSTALLATION

CROSS-SECTION - GRANDE WEDGE WALL 9° SETBACK REINFORCED 8 ROWS

Grande Wedge Wall 8 rows high (1.5 m or 4.92 ft.), including capping

- > 9° setback
- > Gravity
- > With 2.4 kPa surcharge
- > No slope behind the wall
- > Fill the cavities of the Grande Wedge units with clean stone

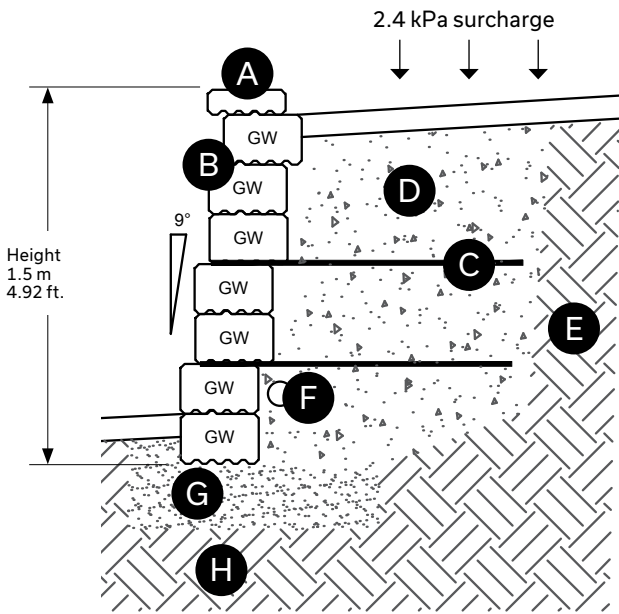

- A Grande Wall - Capping 438 unit
- B Grande Wall - Wedge Standard: 7 rows high
- C Geogrid: 1.3 m - 4.3 ft. minimum length
- D Granular "B" backfill material compacted to min. 95% S.P.M.D.D. Width: 750 mm - 29 1/2 in. behind the wall
- E Undisturbed soil
- F Perforated drain connected to services: 100 mm Ø - 4 in.
- G Granular "A" material compacted to min. 98% S.P.M.D.D. Depth: 200 mm - 8 in. minimum
- H Undisturbed soil or compacted granular foundation: 0 to 20 mm - 0 to 3/4 in. to obtain a min. bearing capacity of 150 kPa

Grande Wedge Wall units are required to create curves with Grande Wall. Permacon is able to provide you with a customized standard cut. For more information, please contact your Permacon representative or send an inquiry directly to our website.

Maximum gravity wall heights assume no slopes or surcharge behind the wall and that the wall retains sand or gravel ($\phi = 34$ degrees, $\gamma = 21 \text{ kN/m}^3$)

GRANDE WALL - INSTALLATION

CROSS-SECTION - GRANDE WEDGE WALL 9° SETBACK REINFORCED 13 ROWS

Grande Wedge Wall 13 rows high (2.5 m or 8.2 ft.), including capping

- > 9° setback
- > Gravity
- > With 2.4 kPa surcharge
- > No slope behind the wall
- > Fill the cavities of the Grande Wedge units with clean stone

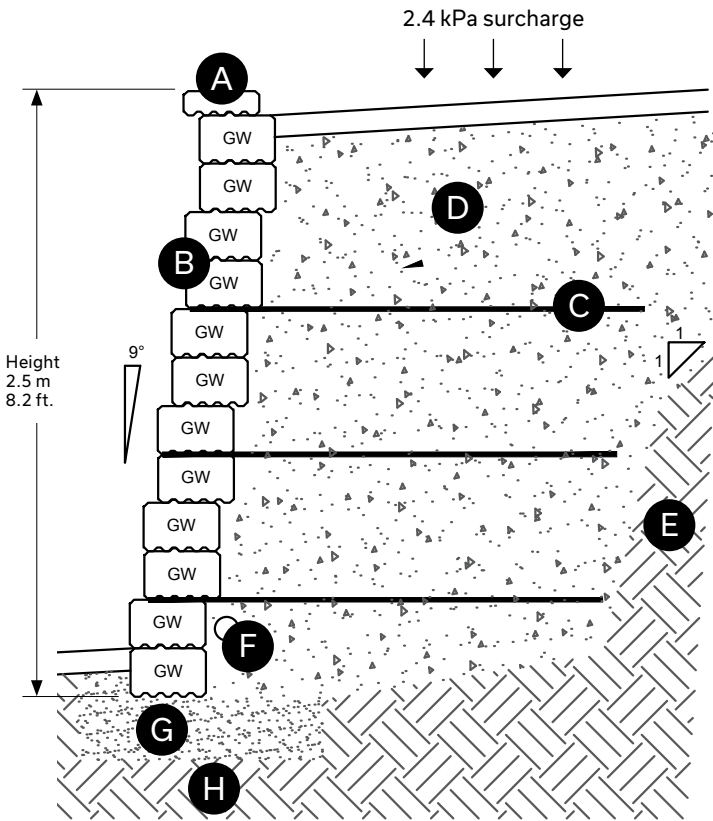

- A Grande Wall – Capping 438 unit
- B Grande Wall – Wedge Standard: 12 rows high
- C Geogrid: 1.5 m - 4.9 ft. minimum length
- D Granular "B" backfill material compacted to min. 95% S.P.M.D.D. - Width: 750 mm - 29 1/2 in. behind the wall
- E Undisturbed soil
- F Perforated drain connected to services: 100 mm Ø - 4 in.
- G Granular "A" material compacted to min. 98% S.P.M.D.D. Depth: 200 mm - 8 in. minimum
- H Undisturbed soil or compacted granular foundation: 0 to 20 mm - 0 to 3/4 in. to obtain a min. bearing capacity of 150 kPa

Grande Wedge Wall units are required to create curves with Grande Wall. Permacon is able to provide you with a customized standard cut. For more information, please contact your Permacon representative or send an inquiry directly to our website.

Maximum gravity wall heights assume no slopes or surcharge behind the wall and that the wall retains sand or gravel ($\phi = 34$ degrees, $\gamma = 21 \text{ kN/m}^3$)

GRANDE WALL - INSTALLATION

CROSS-SECTION - GRANDE WEDGE WALL 9° SETBACK REINFORCED 16 ROWS

Grande Wedge Wall 16 rows high (3.1 m or 10.17 ft.), including capping

- > 9° setback
- > Gravity
- > With 2.4 kPa surcharge
- > No slope behind the wall
- > Fill the cavities of the Grande Wedge units with clean stone

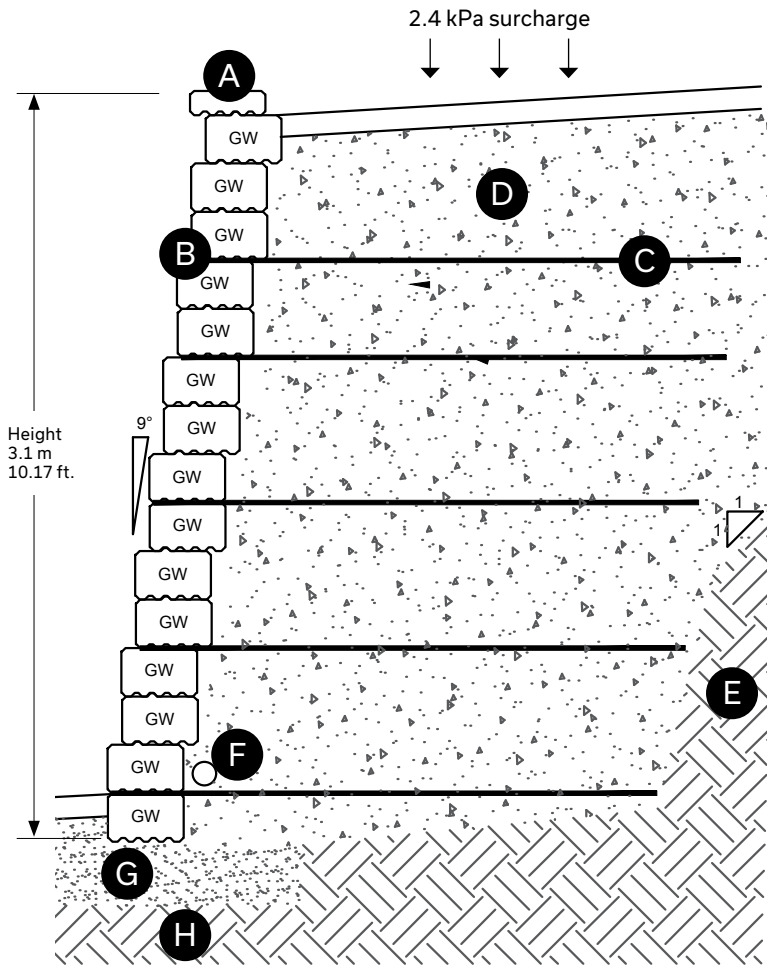

- A** Grande Wall - Capping 438 unit
- B** Grande Wall - Wedge Standard: 15 rows high
- C** Geogrid: 1.8 m - 5.9 ft. minimum length
- D** Granular "B" backfill material compacted to min. 95% S.P.M.D.D. - Width: 750 mm - 29 1/2 in. behind the wall
- E** Undisturbed soil
- F** Perforated drain connected to services: 100 mm Ø - 4 in.
- G** Granular "A" material compacted to min. 98% S.P.M.D.D. - Depth: 200 mm - 8 in. minimum
- H** Undisturbed soil or compacted granular foundation: 0 to 20 mm - 0 to 3/4 in. to obtain a min. bearing capacity of 150 kPa

Grande Wedge Wall units are required to create curves with Grande Wall. Permacon is able to provide you with a customized standard cut. For more information, please contact your Permacon representative or send an inquiry directly to our website.

Maximum gravity wall heights assume no slopes or surcharge behind the wall and that the wall retains sand or gravel ($\phi = 34$ degrees, $\gamma = 21 \text{ kN/m}^3$)

GRANDE WALL - INSTALLATION

CROSS-SECTION - GRANDE WALL 17° SETBACK REINFORCED 9 ROWS

Grande Wall 9 rows high (1.8 m or 5.9 ft.), including capping

- > 17° setback
- > Reinforced with geogrid. Recommended geogrid: Miragrid 3XT
- > With 2.4 kPa surcharge
- > No slope behind the wall

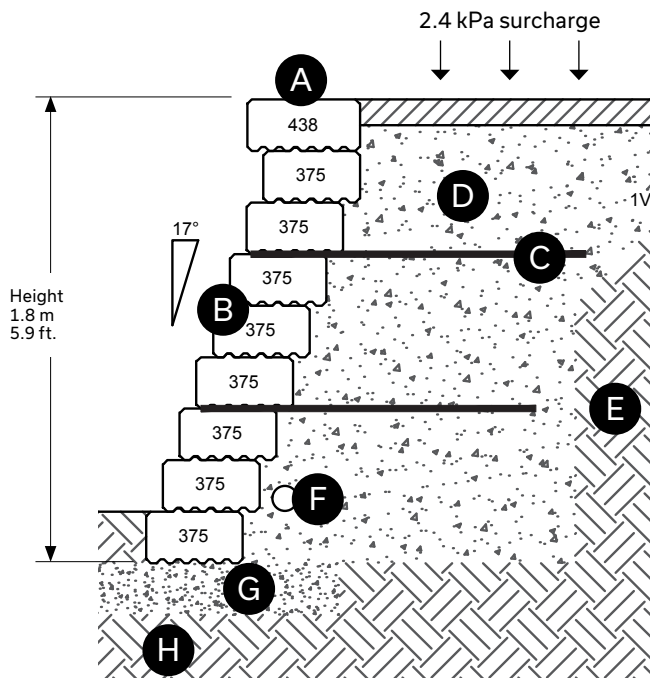

- A** Grande Wall – Capping 438 unit
- B** Grande Wall – 375 Standard: 8 rows high
- C** Geogrid: 1.4 m - 4.6 ft. minimum length
- D** Granular "B" backfill material compacted to min. 95% S.P.M.D.D. Width: 375 mm - 14 3/4 in. behind the wall
- E** Undisturbed soil
- F** Perforated drain connected to services: 100 mm Ø - 4 in.
- G** Granular "A" material compacted to min. 98% S.P.M.D.D. Depth: 200 mm - 8 in. minimum
- H** Undisturbed soil or compacted granular foundation: 0 to 20 mm - 0 to 3/4 in. to obtain a min. bearing capacity of 150 kPa

Maximum gravity wall heights assume no slopes or surcharge behind the wall and that the wall retains sand or gravel ($\phi = 34$ degrees, $\gamma = 21 \text{ kN/m}^3$)

GRANDE WALL - INSTALLATION

CROSS-SECTION - GRANDE WALL 17° SETBACK REINFORCED 12 ROWS

Grande Wall 12 rows high (2.4 m or 7.9 ft.), including capping

- > 17° setback
- > Reinforced with geogrid. Recommended geogrid: Miragrid 3XT
- > With 2.4 kPa surcharge
- > No slope behind the wall

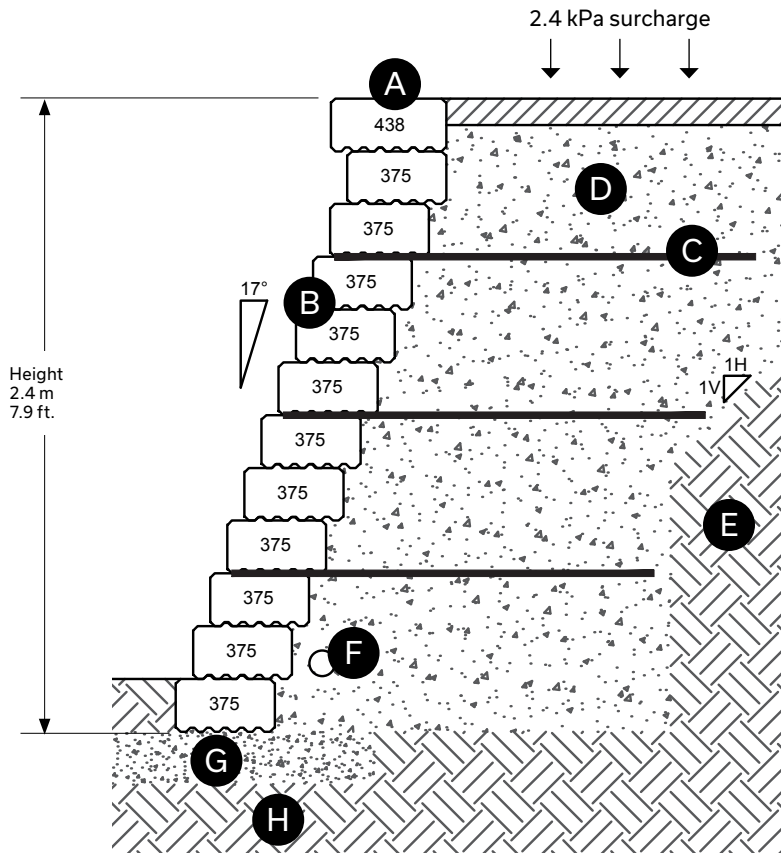

- A Grande Wall - Capping 438 unit
- B Grande Wall - 375 Standard: 11 rows high
- C Geogrid: 1.6 m - 5.2 ft. minimum length
- D Granular "B" backfill material compacted to min. 95% S.P.M.D.D. - Width: 375 mm - 14 3/4 in. behind the wall
- E Undisturbed soil
- F Perforated drain connected to services: 100 mm O - 4 in.
- G Granular "A" material compacted to min. 98% S.P.M.D.D. - Depth: 200 mm - 8 in. minimum
- H Undisturbed soil or compacted granular foundation: 0 to 20 mm - 0 to 3/4 in. to obtain a min. bearing capacity of 150 kPa

Maximum gravity wall heights assume no slopes or surcharge behind the wall and that the wall retains sand or gravel ($\phi = 34$ degrees, $\gamma = 21 \text{ kN/m}^3$)

GRANDE WALL - INSTALLATION

CROSS-SECTION - GRANDE WALL 17° SETBACK REINFORCED 15 ROWS

Grande Wall 15 rows high (3 m or 9.8 ft.), including capping

- > 17° setback
- > Reinforced with geogrid. Recommended geogrid: Miragrid 3XT
- > With 2.4 kPa surcharge
- > No slope behind the wall

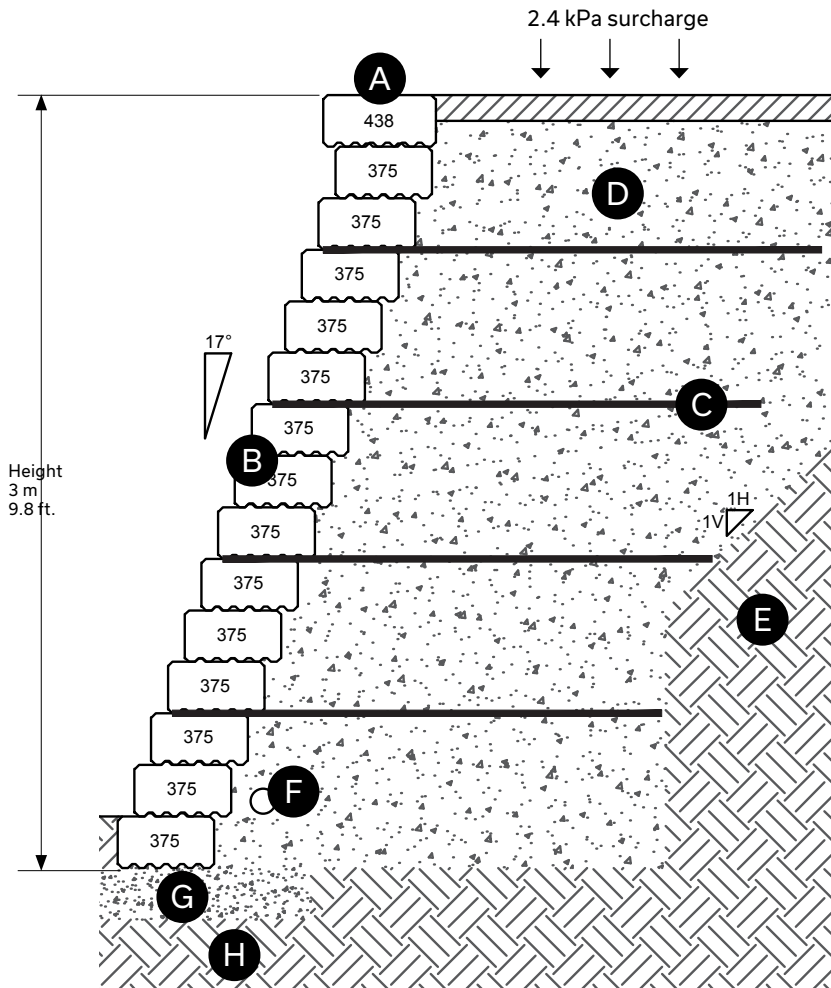

- A** Grande Wall – Capping 438 unit
- B** Grande Wall – 375 Standard: 14 rows high
- C** Geogrid: 1.9 m - 6.2 ft. minimum length
- D** Granular "B" backfill material compacted to min. 95% S.P.M.D.D. - Width: 375 mm - 14 3/4 in. behind the wall
- E** Undisturbed soil
- F** Perforated drain connected to services: 100 mm O - 4 in.
- G** Granular "A" material compacted to min. 98% S.P.M.D.D. - Depth: 200 mm - 8 in. minimum
- H** Undisturbed soil or compacted granular foundation: 0 to 20 mm - 0 to 3/4 in. to obtain a min. bearing capacity of 150 kPa

Maximum gravity wall heights assume no slopes or surcharge behind the wall and that the wall retains sand or gravel ($\phi = 34$ degrees, $\gamma = 21 \text{ kN/m}^3$)

GRANDE WALL - INSTALLATION

CROSS-SECTION - GRANDE WEDGE WALL 17° SETBACK REINFORCED 8 ROWS

Grande Wedge Wall 8 rows high (1.5 m or 4.92 ft.), including capping

- > 17° setback
- > Reinforced with geogrid. Recommended geogrid: Miragrid 3XT
- > With 2.4 kPa surcharge
- > No slope behind the wall
- > Fill the cavities of the Grande Wedge units with clean stone

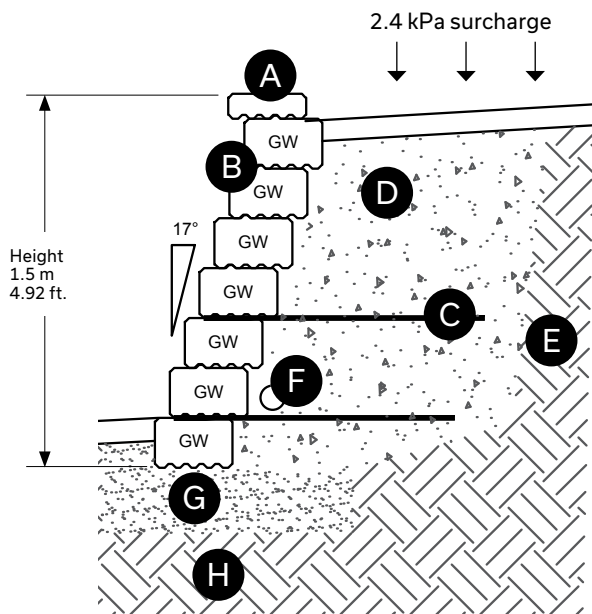

- Ⓐ Grande Wall – Capping 438 unit
- Ⓑ Grande Wall – Wedge Standard: 7 rows high
- Ⓒ Geogrid: 1.3 m - 4.3 ft. minimum length
- Ⓓ Granular "B" backfill material compacted to min. 95% S.P.M.D.D. Width: 750 mm - 29 1/2 in. behind the wall
- Ⓔ Undisturbed soil
- Ⓕ Perforated drain connected to services: 100 mm Ø - 4 in.
- Ⓖ Granular "A" material compacted to min. 98% S.P.M.D.D. Depth: 200 mm - 8 in. minimum
- Ⓗ Undisturbed soil or compacted granular foundation: 0 to 20 mm - 0 to 3/4 in. to obtain a min. bearing capacity of 150 kPa

Grande Wedge Wall units are required to create curves with Grande Wall. Permacon is able to provide you with a customized standard cut. For more information, please contact your Permacon representative or send an inquiry directly to our website.

Maximum gravity wall heights assume no slopes or surcharge behind the wall and that the wall retains sand or gravel ($\phi = 34$ degrees, $\gamma = 21 \text{ kN/m}^3$)

GRANDE WALL - INSTALLATION

CROSS-SECTION - GRANDE WEDGE WALL 17° SETBACK REINFORCED 13 ROWS

Grande Wedge Wall 13 rows high (2.5 m or 8.2 ft.), including capping

- > 17° setback
- > Reinforced with geogrid. Recommended geogrid: Miragrid 3XT
- > With 2.4 kPa surcharge
- > No slope behind the wall
- > Fill the cavities of the Grande Wedge units with clean stone

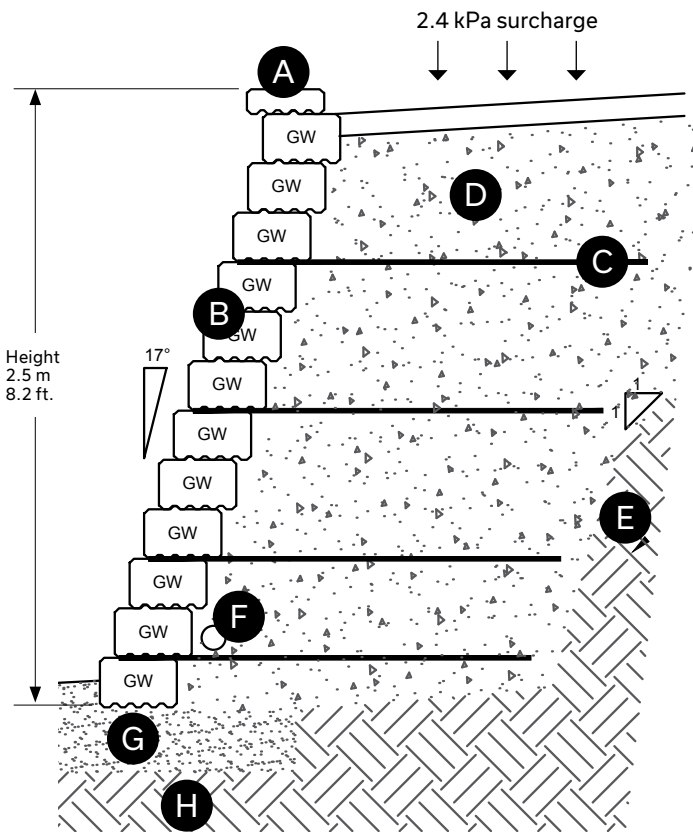

- Ⓐ Grande Wall – Capping 438 unit
- Ⓑ Grande Wall – Wedge Standard: 12 rows high
- Ⓒ Geogrid: 1.5 m - 4.9 ft. minimum length
- Ⓓ Granular "B" backfill material compacted to min. 95% S.P.M.D.D. - Width: 750 mm - 29 1/2 in. behind the wall
- Ⓔ Undisturbed soil
- Ⓕ Perforated drain connected to services: 100 mm Ø - 4 in.
- Ⓖ Granular "A" material compacted to min. 98% S.P.M.D.D. Depth: 200 mm - 8 in. minimum
- Ⓗ Undisturbed soil or compacted granular foundation: 0 to 20 mm - 0 to 3/4 in. to obtain a min. bearing capacity of 150 kPa

Grande Wedge Wall units are required to create curves with Grande Wall. Permacon is able to provide you with a customized standard cut. For more information, please contact your Permacon representative or send an inquiry directly to our website.

Maximum gravity wall heights assume no slopes or surcharge behind the wall and that the wall retains sand or gravel ($\phi = 34$ degrees, $\gamma = 21 \text{ kN/m}^3$)

GRANDE WALL - INSTALLATION

CROSS-SECTION - GRANDE WEDGE WALL 17° SETBACK REINFORCED 16 ROWS

Grande Wedge Wall 16 rows high (3.1 m or 10.17 ft.), including capping

- > 17° setback
- > Reinforced with geogrid. Recommended geogrid: Miragrid 3XT
- > With 2.4 kPa surcharge
- > No slope behind the wall
- > Fill the cavities of the Grande Wedge units with clean stone

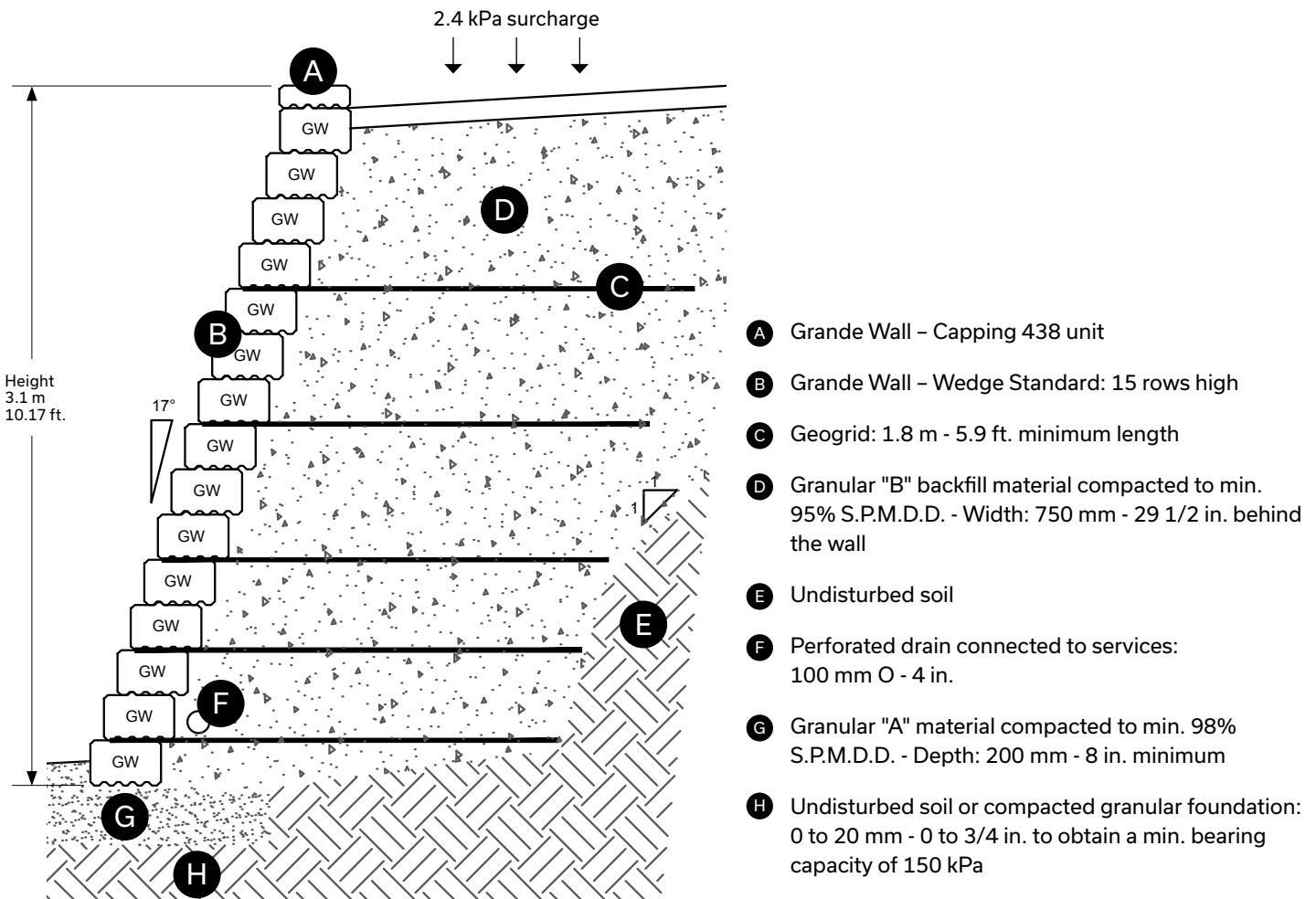

Grande Wedge Wall units are required to create curves with Grande Wall. Permacon is able to provide you with a customized standard cut. For more information, please contact your Permacon representative or send an inquiry directly to our website.

Maximum gravity wall heights assume no slopes or surcharge behind the wall and that the wall retains sand or gravel ($\phi = 34$ degrees, $\gamma = 21 \text{ kN/m}^3$)

GRANDE WALL - INSTALLATION

CROSS-SECTION - GRANDE WALL STRAIGHT REINFORCED 6 ROWS

Grande Wall 6 rows high (1.2 m or 3.9 ft.), including capping

- > Straight
- > Reinforced with geogrid. Recommended geogrid: Miragrid 3XT
- > With 2.4 kPa surcharge
- > No slope behind the wall

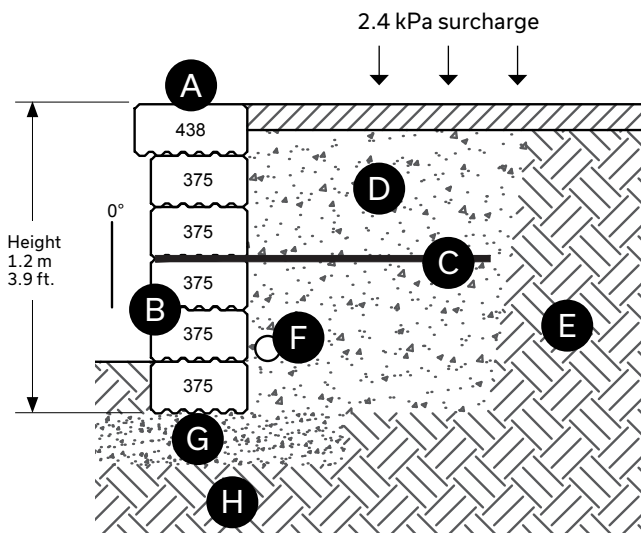

- Ⓐ Grande Wall – Capping 438 unit
- Ⓑ Grande Wall – 375 Standard: 5 rows high
- Ⓒ Geogrid: 1.3 m - 4.3 ft. minimum length
- Ⓓ Granular "B" backfill material compacted to min. 95% S.P.M.D.D. Width: 375 mm - 14 3/4 in. behind the wall
- Ⓔ Undisturbed soil
- Ⓕ Perforated drain connected to services: 100 mm Ø - 4 in.
- Ⓖ Granular "A" material compacted to min. 98% S.P.M.D.D. Depth: 200 mm - 8 in. minimum
- Ⓗ Undisturbed soil or compacted granular foundation: 0 to 20 mm - 0 to 3/4 in. to obtain a min. bearing capacity of 150 kPa

Maximum gravity wall heights assume no slopes or surcharge behind the wall and that the wall retains sand or gravel ($\phi = 34$ degrees, $\gamma = 21 \text{ kN/m}^3$)

GRANDE WALL - INSTALLATION

CROSS-SECTION - GRANDE WALL STRAIGHT REINFORCED 12 ROWS

Grande Wall 12 rows high (2.4 m or 7.9 ft.), including capping

- > Straight
- > Reinforced with geogrid. Recommended geogrid: Miragrid 3XT
- > With 2.4 kPa surcharge
- > No slope behind the wall

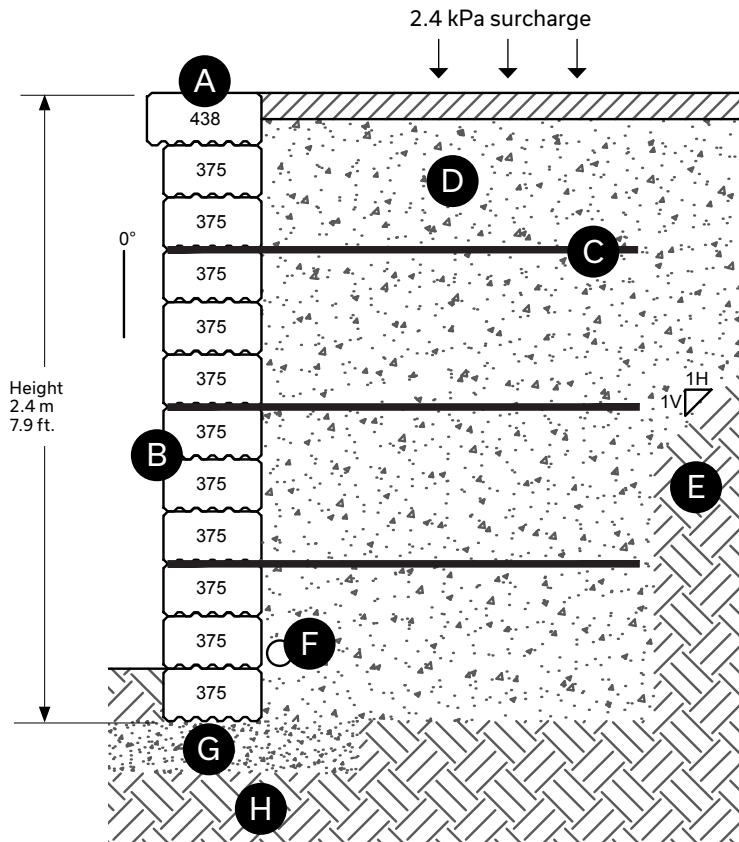

- Ⓐ Grande Wall – Capping 438 unit
- Ⓑ Grande Wall – 375 Standard: 11 rows high
- Ⓒ Geogrid: 1.8 m - 5.9 ft. minimum length
- Ⓓ Granular "B" backfill material compacted to min. 95% S.P.M.D.D. - Width: 375 mm - 14 3/4 in. behind the wall
- Ⓔ Undisturbed soil
- Ⓕ Perforated drain connected to services: 100 mm Ø - 4 in.
- Ⓖ Granular "A" material compacted to min. 98% S.P.M.D.D. - Depth: 200 mm - 8 in. minimum
- Ⓗ Undisturbed soil or compacted granular foundation: 0 to 20 mm - 0 to 3/4 in. to obtain a min. bearing capacity of 150 kPa

Maximum gravity wall heights assume no slopes or surcharge behind the wall and that the wall retains sand or gravel ($\phi = 34$ degrees, $\gamma = 21 \text{ kN/m}^3$)

GRANDE WALL - INSTALLATION

CROSS-SECTION - GRANDE WALL STRAIGHT REINFORCED 15 ROWS

Grande Wall 15 rows high (3 m or 9.8 ft.), including capping

- > Straight
- > Reinforced with geogrid. Recommended geogrid: Miragrid 3XT
- > With 2.4 kPa surcharge
- > No slope behind the wall

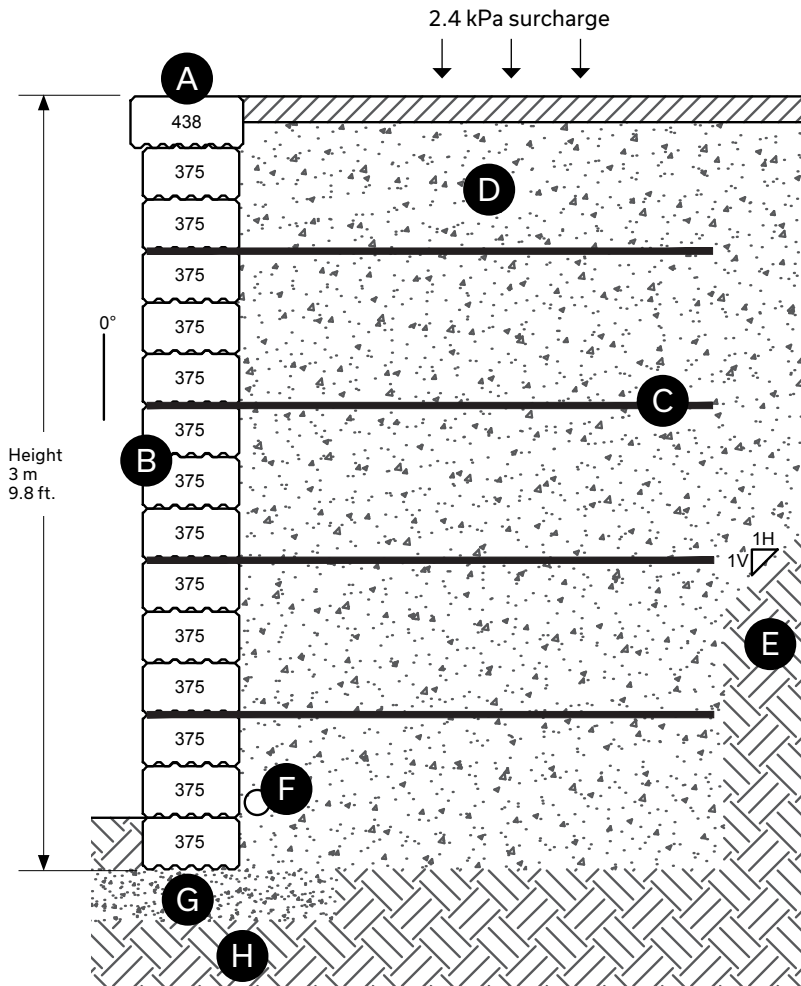

- A** Grande Wall – Capping 438 unit
- B** Grande Wall – 375 Standard: 14 rows high
- C** Geogrid: 2.2 m - 7.2 ft. minimum length
- D** Granular "B" backfill material compacted to min. 95% S.P.M.D.D. - Width: 375 mm - 14 3/4 in. behind the wall
- E** Undisturbed soil
- F** Perforated drain connected to services: 100 mm O - 4 in.
- G** Granular "A" material compacted to min. 98% S.P.M.D.D. - Depth: 200 mm - 8 in. minimum
- H** Undisturbed soil or compacted granular foundation: 0 to 20 mm - 0 to 3/4 in. to obtain a min. bearing capacity of 150 kPa

Maximum gravity wall heights assume no slopes or surcharge behind the wall and that the wall retains sand or gravel ($\phi = 34$ degrees, $\gamma = 21 \text{ kN/m}^3$)

GRANDE WALL - INSTALLATION

CROSS-SECTION - GRANDE WEDGE WALL STRAIGHT REINFORCED 8 ROWS

Grande Wedge Wall 8 rows high (1.3 m or 4.27 ft.), including capping

- > Straight
- > Reinforced with geogrid. Recommended geogrid: Miragrid 3XT
- > With 2.4 kPa surcharge
- > No slope behind the wall
- > Fill the cavities of the Grande Wedge units with clean stone

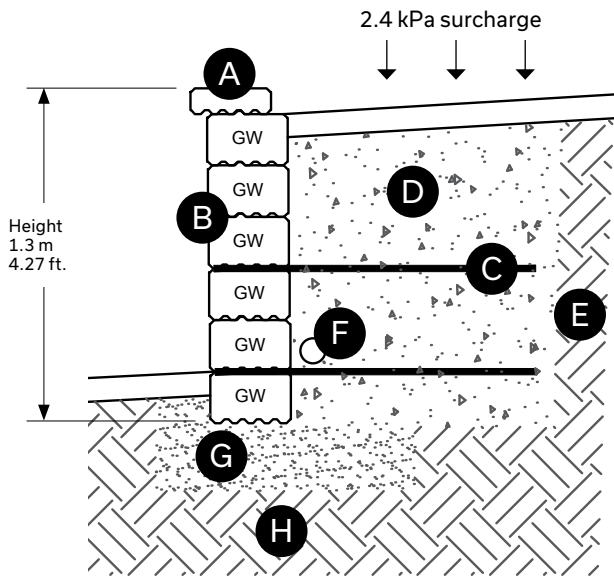

- Ⓐ Grande Wall - Capping 438 unit
- Ⓑ Grande Wall - Wedge Standard: 7 rows high
- Ⓒ Geogrid: 1.3 m - 4.3 ft. minimum length
- Ⓓ Granular "B" backfill material compacted to min. 95% S.P.M.D.D. Width: 750 mm - 29 1/2 in. behind the wall
- Ⓔ Undisturbed soil
- Ⓕ Perforated drain connected to services: 100 mm Ø - 4 in.
- Ⓖ Granular "A" material compacted to min. 98% S.P.M.D.D. Depth: 200 mm - 8 in. minimum
- Ⓗ Undisturbed soil or compacted granular foundation: 0 to 20 mm - 0 to 3/4 in. to obtain a min. bearing capacity of 150 kPa

Grande Wedge Wall units are required to create curves with Grande Wall. Permacon is able to provide you with a customized standard cut. For more information, please contact your Permacon representative or send an inquiry directly to our website.

Maximum gravity wall heights assume no slopes or surcharge behind the wall and that the wall retains sand or gravel ($\phi = 34$ degrees, $\gamma = 21 \text{ kN/m}^3$)

GRANDE WALL - INSTALLATION

CROSS-SECTION - GRANDE WEDGE WALL STRAIGHT REINFORCED 12 ROWS

Grande Wedge Wall 12 rows high (2.3 m or 7.55 ft.), including capping

- > Straight
- > Reinforced with geogrid. Recommended geogrid: Miragrid 3XT
- > With 2.4 kPa surcharge
- > No slope behind the wall
- > Fill the cavities of the Grande Wedge units with clean stone

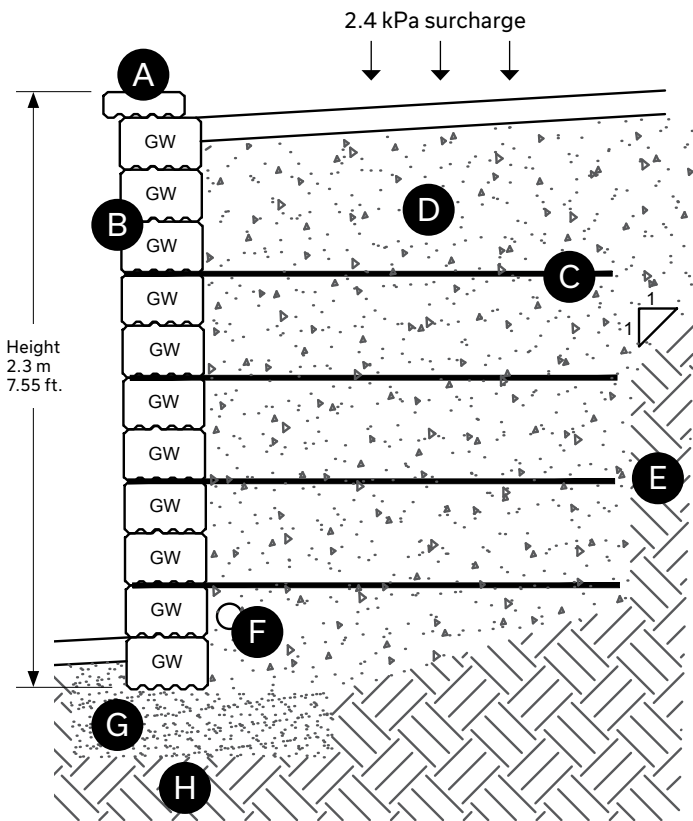

- A Grande Wall - Capping 438 unit
- B Grande Wall - Wedge Standard: 11 rows high
- C Geogrid: 1.6 m - 5.2 ft. minimum length
- D Granular "B" backfill material compacted to min. 95% S.P.M.D.D. - Width: 750 mm - 29 1/2 in. behind the wall
- E Undisturbed soil
- F Perforated drain connected to services: 100 mm Ø - 4 in.
- G Granular "A" material compacted to min. 98% S.P.M.D.D. Depth: 200 mm - 8 in. minimum
- H Undisturbed soil or compacted granular foundation: 0 to 20 mm - 0 to 3/4 in. to obtain a min. bearing capacity of 150 kPa

Grande Wedge Wall units are required to create curves with Grande Wall. Permacon is able to provide you with a customized standard cut. For more information, please contact your Permacon representative or send an inquiry directly to our website.

Maximum gravity wall heights assume no slopes or surcharge behind the wall and that the wall retains sand or gravel ($\phi = 34$ degrees, $\gamma = 21 \text{ kN/m}^3$)

GRANDE WALL - INSTALLATION

CROSS-SECTION - GRANDE WEDGE WALL STRAIGHT REINFORCED 15 ROWS

Grande Wedge Wall 15 rows high (2.9 m or 9.51 ft.), including capping

- > Straight
- > Reinforced with geogrid. Recommended geogrid: Miragrid 3XT
- > With 2.4 kPa surcharge
- > No slope behind the wall
- > Fill the cavities of the Grande Wedge units with clean stone

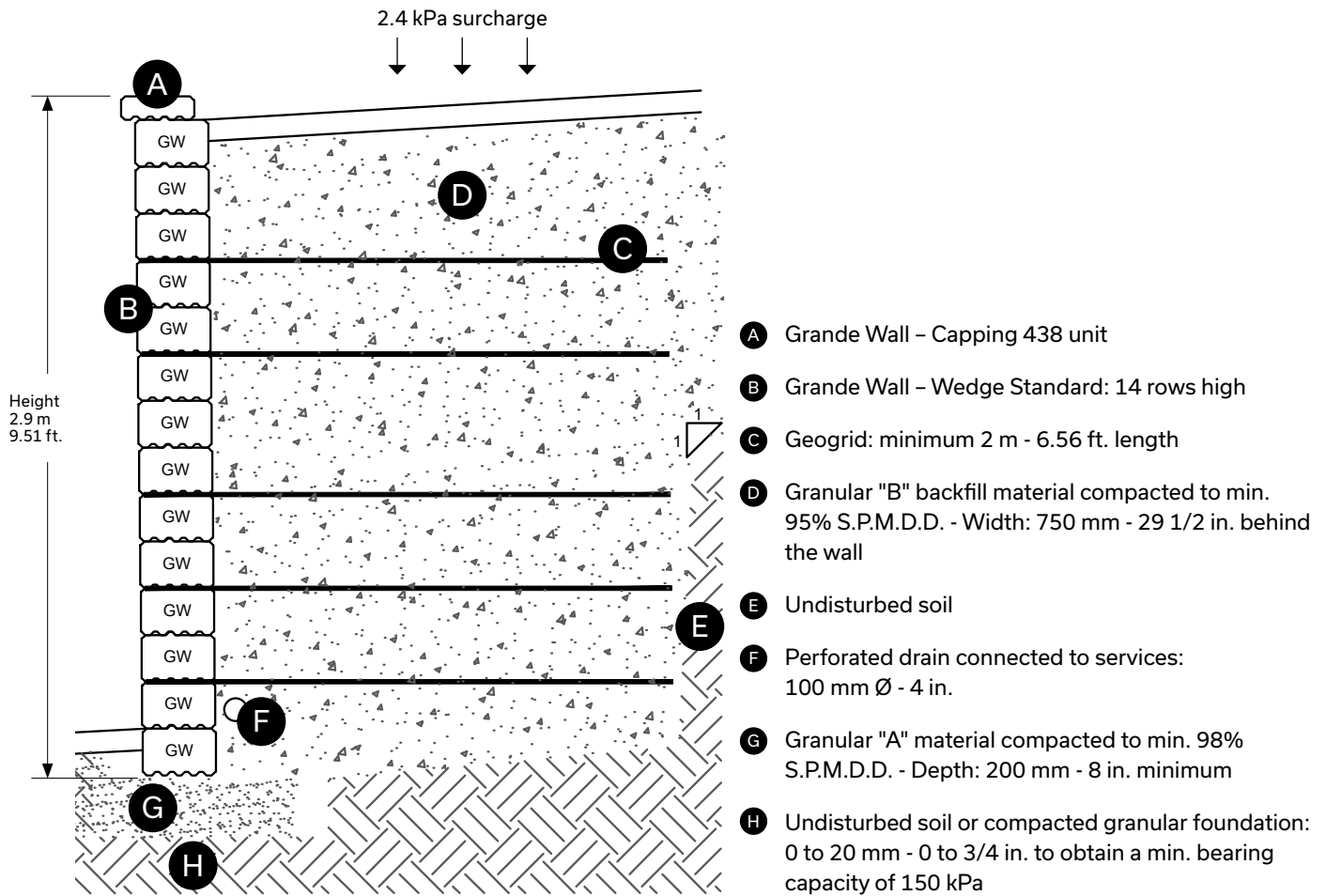

Grande Wedge Wall units are required to create curves with Grande Wall. Permacon is able to provide you with a customized standard cut. For more information, please contact your Permacon representative or send an inquiry directly to our website.

Maximum gravity wall heights assume no slopes or surcharge behind the wall and that the wall retains sand or gravel ($\phi = 34$ degrees, $\gamma = 21 \text{ kN/m}^3$)

GRANDE WALL - INSTALLATION

CROSS-SECTION - CREATING GRANDE WALL STEPS

To create steps, follow these instructions:

- > Start with a Grande Wall 375 Standard unit buried in the soil
- > Use Grande Step 175 units
- > Install the units in a way to create a running bond pattern with the steps
- > The stair width varies according to the local building code

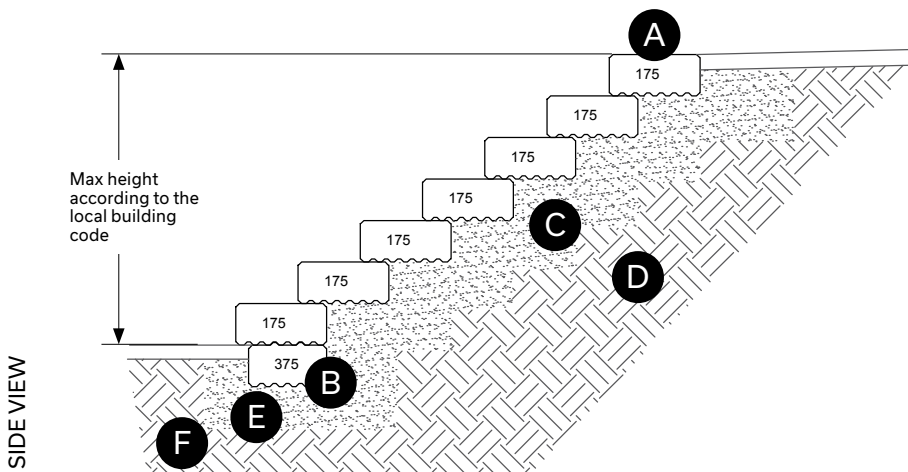
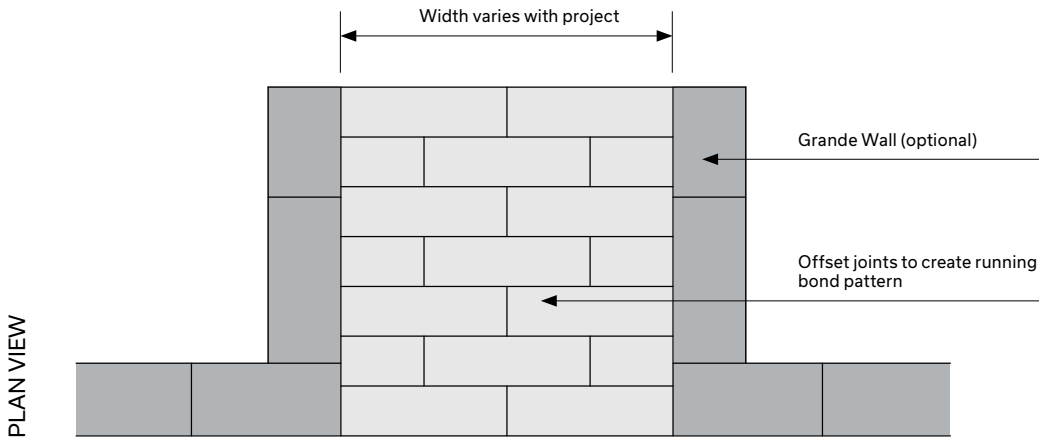

- Ⓐ Grande Wall – Step 175
- Ⓑ Grande Wall – 375 Standard buried in the soil
- Ⓒ Granular "B" backfill material compacted to min. 95% S.P.M.D.D.
- Ⓓ Undisturbed soil
- Ⓔ Granular "A" material compacted to min. 98% S.P.M.D.D.
- Ⓕ Undisturbed soil or compacted granular foundation: 0 to 20 mm - 0 to 3/4 in. to obtain a min. bearing capacity of 150 kPa

Maximum gravity wall heights assume no slopes or surcharge behind the wall and that the wall retains sand or gravel ($\phi = 34$ degrees, $\gamma = 21 \text{ kN/m}^3$)

GRANDE WALL - INSTALLATION

CROSS-SECTION - ADDITION OF A FENCE OR RAILING

GRANDE WALL FENCE

To build a fence using Grande Wall units, follow these instructions:

- > Use fence posts with a diameter of maximum 75 mm - 3 in.
- > Fill the core holes in Grande Wall, drilled to put in the fence, with non-shrink grout.
- > The fence must be reinforced with geogrid or Grande Wall 750 Standard unit, as shown below
- > When using geogrid, the length of the geogrid should respect the cross-section shown in the guide, according to the wall height. Recommended geogrid: Miragrid 3XT
- > The depth of the posts core varies according to the fence used. Contact your Permacon representative for more information.

Install the fence or railing at a distance of at least 125 mm - 5 in. from Grande Wall units edge

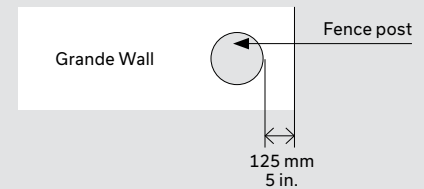

Grande Wall fence reinforced with geogrid

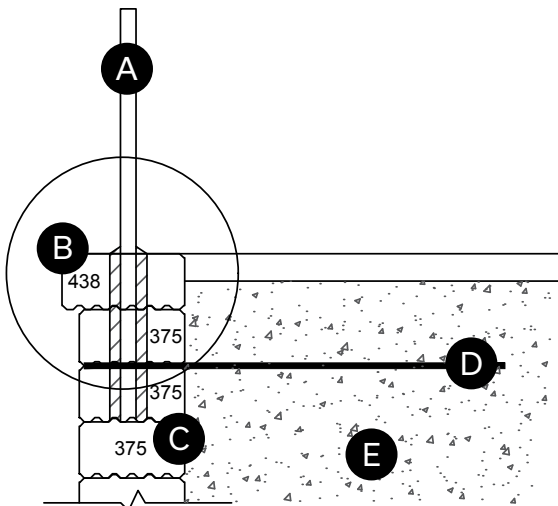

- Ⓐ Steel handrail or chain-link fence: posts core drilled in Grande Wall units (variable depth) with non-shrink grout.
Posts diameter: 75 mm - 3 in. maximum
Distance between the post holes and the edge of Grande Wall units: 125 mm - 5 in.
- Ⓑ Grande Wall - Capping 438
- Ⓒ Grande Wall - Standard 375
- Ⓓ Geogrid
- Ⓔ Granular "B" backfill material compacted to minimum 95% S.S.P.M.D.

Grande Wall fence reinforced with 750 Standard unit

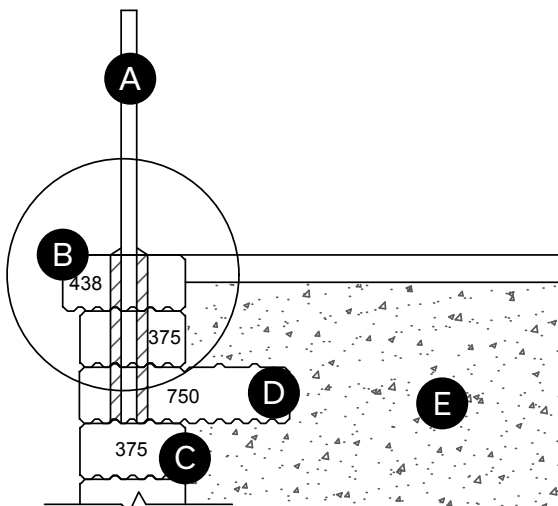

- Ⓐ Steel handrail or chain-link fence: posts core drilled in Grande Wall units (variable depth) with non-shrink grout.
Posts diameter: 75 mm - 3 in. maximum
Distance between the post holes and the edge of Grande Wall units: 125 mm - 5 in.
- Ⓑ Grande Wall - Capping 438
- Ⓒ Grande Wall - Standard 375
- Ⓓ Grande Wall - Standard 750
- Ⓔ Granular "B" backfill material compacted to minimum 95% S.S.P.M.D.

GRANDE WALL - INSTALLATION

CROSS-SECTION - ADDITION OF A FENCE OR RAILING (CONT'D)

FENCE BEHIND GRANDE WALL

To build a fence behind the Grande Wall units, follow these instructions:

- > Install the fence or railing in a sonotube of minimum 1.2 m - 3.9 ft. in depth
- > The wall and fence must be reinforced with a geogrid. The length of the geogrid should respect the cross-section shown in the guide, according to the wall height. Recommended geogrid: Miragrid 3XT

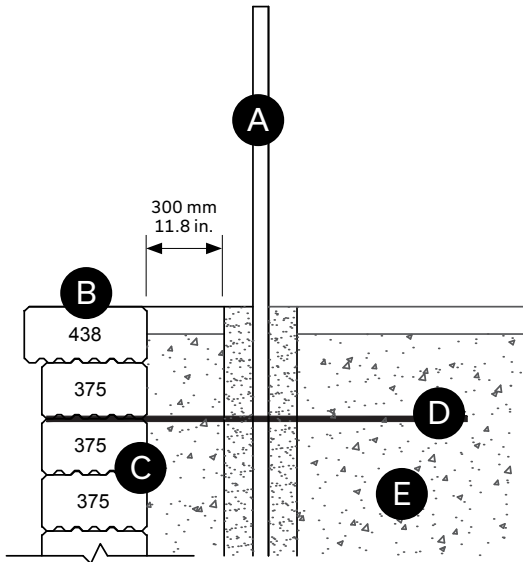

- A** Handrail or fence cast in sonotube behind the Grande Wall
Distance between the sonotube the edge of Grande Wall units:
300 mm - 11.8 in.
Sonotube depth: 1.2 m - 3.9 ft
- B** Grande Wall - Capping 438
- C** Grande Wall - Standard 375
- D** Geogrid
- E** Granular "B" backfill material compacted to minimum 95% S.S.P.M.D.

GRANDE WALL - INSTALLATION

CROSS-SECTION - ADDITION OF A FENCE OR RAILING (CONT'D)

FENCE ON TOP OF GRANDE WALL

To build a fence on top of the Grande Wall units, follow these instructions:

- > Use fence posts with a diameter of maximum 75 mm - 3 in.
- > Install the fence or railing at a distance of at least 125 mm- 5 in. from Grande Wall unit edge
- > To strengthen the fence or railing, insert bars coated with epoxy, in the Grande Wall units.
Recommended epoxy: HILTI-RE 500 V3

Fence on top of Grande Wall reinforced with geogrid

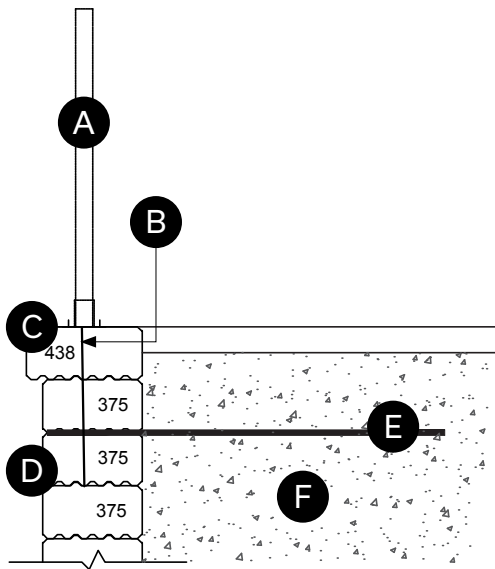

- A** Steel handrail or chain-link fence
- B** Bars coated with epoxy type: HILTI-RE 500 V3 or equivalent
Bars depth: minimum 3 rows of Grande Wall
Diameter of holes in Grande Wall units: 20 mm - 0.8 in.
Distance between the bars holes and the edge of Grande Wall units: 125 mm - 5 in.
- C** Grande Wall – Capping 438
- D** Grande Wall – Standard 375
- E** Geogrid
- F** Granular "B" backfill material compacted to minimum 95% S.S.P.M.D.

Fence on top of Grande Wall reinforced with 750 Standard unit

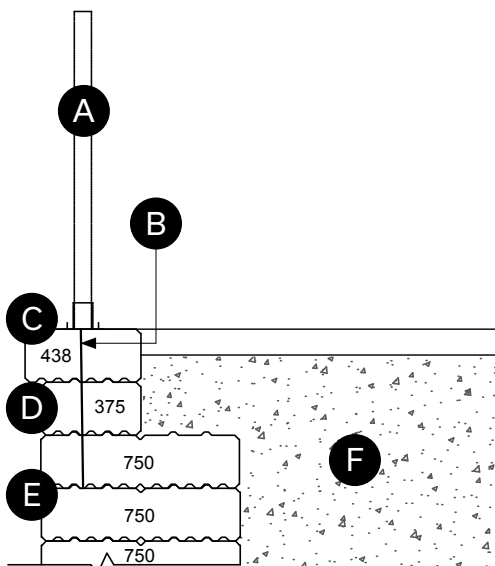

- A** Steel handrail or chain-link fence
- B** Bars coated with epoxy type: HILTI-RE 500 V3 or equivalent
Bars depth: minimum 3 rows of Grande Wall
Diameter of holes in Grande Wall units: 20 mm - 0.8 in.
Distance between the bars holes and the edge of Grande Wall units: 125 mm - 5 in.
- C** Grande Wall – Capping 438
- D** Grande Wall – Standard 375
- E** Grande Wall – Standard 750
- F** Granular "B" backfill material compacted to minimum 95% S.S.P.M.D.

GRANDE WALL - INSTALLATION

CROSS-SECTION - ADDITION OF A FENCE OR RAILING (CONT'D)

VEHICULAR GUARD BEHIND GRANDE WALL

To build a vehicular guard behind Grande Wall units, follow these instructions:

- > Install the vehicular guard at a distance of at least 300 mm (11.8 in.) from Grande Wall units edge and at a depth of at least 1.2 m - 3.9 ft.
- > The wall and vehicular guard must be reinforced with a geogrid. The length of the geogrid should respect the cross-section shown in the guide, according to the wall height. Recommended geogrid: Miragrid 3XT

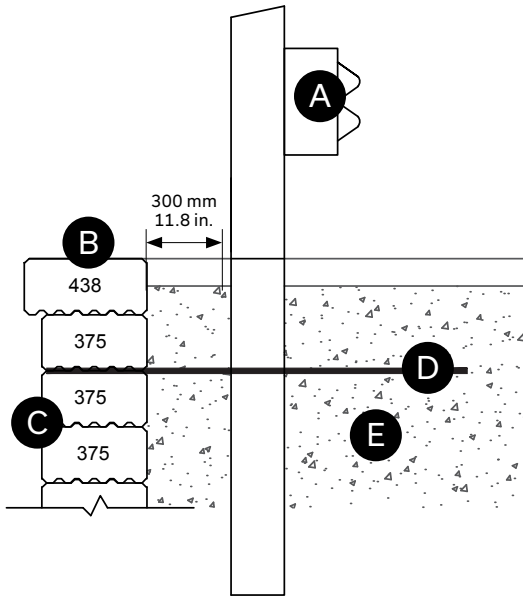

- A** Vehicular guard
Distance between the guard and the edge of Grande Wall units:
300 mm - 11.8 po
Depth of guard: 1.2 m - 3.9 ft. min.
- B** Grande Wall – Capping 438
- C** Grande Wall – Standard 375
- D** Geogrid
- E** Granular "B" backfill material compacted to minimum 95% S.S.P.M.D.

CROSS-SECTION - DRAIN

DRAIN OUTLET THROUGH GRANDE WALL

When not connected to services, the drain behind the Grande Wall must go through the Grande Wall units at every 15 m - 49.2 ft., according to these instructions:

- > Install a filter fabric over the drain outlet to prevent migration of granular material through notch
- > There are two ways to create the hole in the Grande Wall:
 - Option 1: Cut the Grande Wall units around the drain outlet **OR**
 - Option 2: Install the Grande Wall units against the drain outlet, which leaves a hole above the drain outlet

Option 1: Grande Wall units cut around the drain outlet

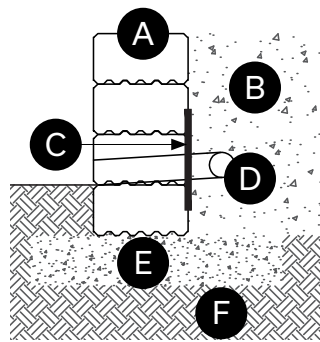
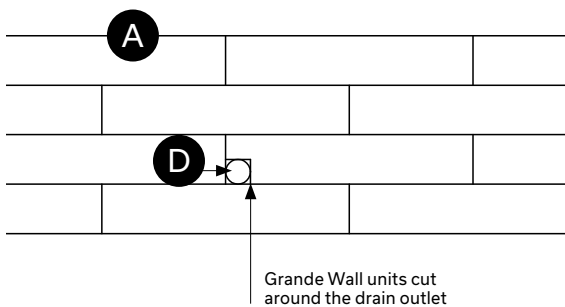

- A** Grande Wall - Standard 375
- B** Granular "B" backfill material compacted to minimum 95% S.S.P.M.D
- C** Filter fabric over the drain outlet to prevent migration of granular material through notch
- D** Perforated drain Ø 100 mm - 4 in with a filter sock at the opening (Grande Wall face)
- E** Granular "A" material compacted to min. 98% S.P.M.D.D.
- F** Undisturbed soil

Option 2: Grande Wall units installed against the drain outlet

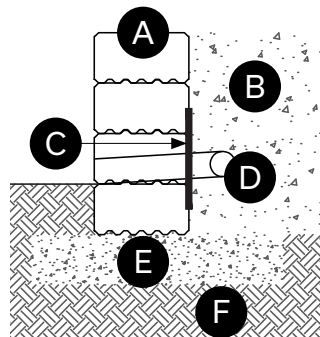
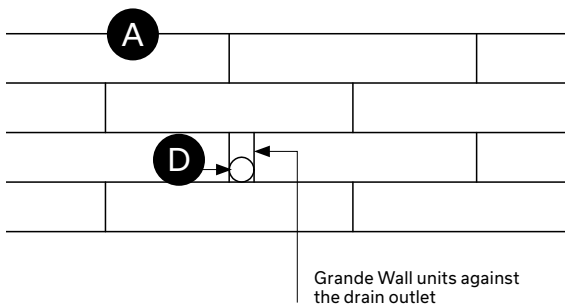

- A** Grande Wall - Standard 375
- B** Granular "B" backfill material compacted to minimum 95% S.S.P.M.D
- C** Filter fabric over the drain outlet to prevent migration of granular material through notch
- D** Perforated drain Ø 100 mm - 4 in with a filter sock at the opening (Grande Wall face)
- E** Granular "A" material compacted to min. 98% S.P.M.D.D.
- F** Undisturbed soil

GRANDE WALL - INSTALLATION

CROSS-SECTION - GRANDE WALL AGAINST A BUILDING

To install the Grande Wall against an existing wall, follow these instructions:

- > Install a filter fabric against the Grande Wall and the existing wall. Fabric length: 0.5 m - 1.7 ft. minimum on each structure - Grande Wall and existing wall. Fabric height: same as Grande Wall

Straight abutment

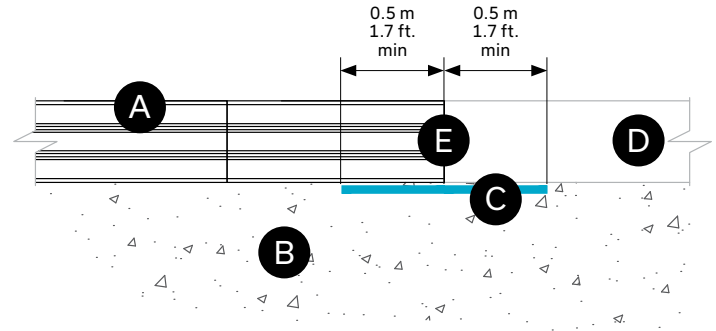
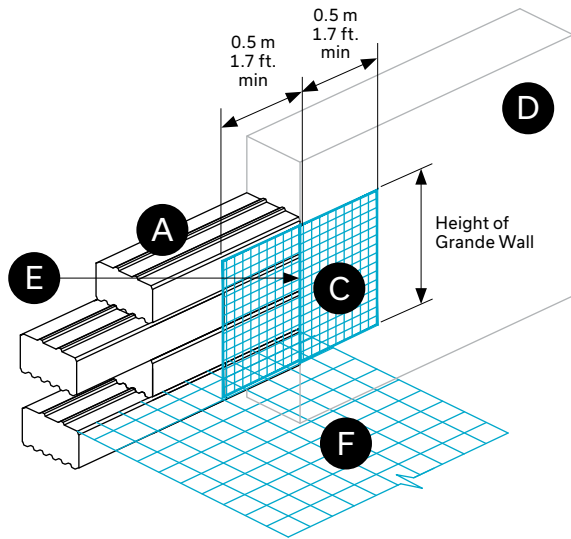

- A** Grande Wall
- B** Granular "B" backfill material compacted to minimum 95% S.S.P.M.D.
- C** Filter fabric
Length: 0.5 m - 1.7 ft. minimum on each structure
Height: same as Grande Wall
- D** Existing wall or building
- E** Grande Wall units cut against the existing building
- F** Geogrid if required

Corner abutment

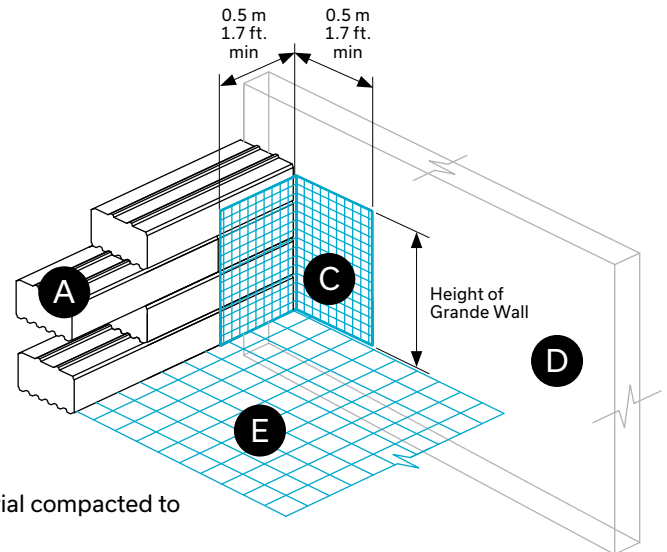
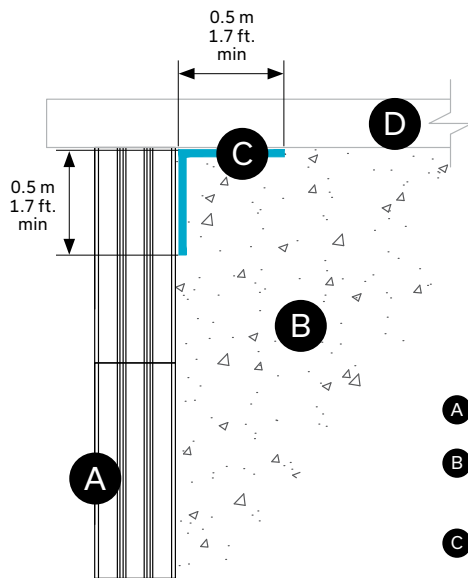

- A** Grande Wall
- B** Granular "B" backfill material compacted to minimum 95% S.S.P.M.D.
- C** Filter fabric
Length: 0.5 m - 1.7 ft. minimum on each structure
Height: same as Grande Wall
- D** Existing wall or building
- E** Geogrid if required

Wall Installation Guidelines

TYPICAL CROSS-SECTION - GRANDE, WALLSTONE AND RB WALL

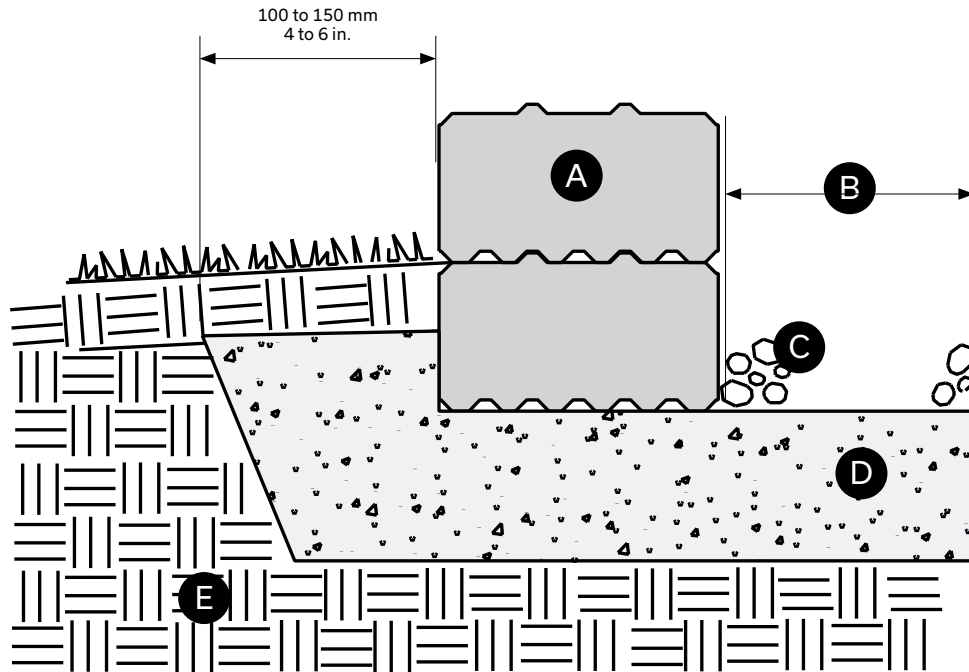

- **A** Retaining wall system manufactured by Permacon
- **B** Equal to depth of backfill: depth varies
- **C** Compacted granular backfill: depth varies
- **D** Compacted aggregate base: thickness varies (minimum 200 mm - 8 in.)
- **E** Compacted soil subgrade

WALL INSTALLATION GUIDELINES

GENERAL INFORMATION - GRANDE, WALLSTONE AND RB WALL

These installation guidelines apply to garden and decorative walls built with any Permacon retaining wall system. For large structural or retaining walls, walls that exceed the maximum recommended height or walls in areas of poor drainage of soil conditions, please contact your Permacon sales representative for more specific installation requirements.

DESIGN CONSIDERATIONS

When planning a garden or retaining wall, you should ask yourself several questions to ensure your finished installation will look good and last a lifetime.

- > How high will the wall be? Height of the wall should always include a minimum of one buried base course in addition to the height above ground. Different wall systems have different height capabilities. Be sure not to exceed the maximum recommended height for the wall product you choose.
- > Will the wall be straight, curved or both? Permacon Grande and Wallstone walls can create circles, soft flowing curves, straight linear designs or any of these in combination. Measure the curved and straight sections of the wall separately to make estimating easier.
- > What is the purpose of the wall? Some wall products are suitable for large retaining wall projects while others are ideal for small garden walls or planters.
- > Will the height of the wall vary? If the property has a slope, the wall height may vary accordingly. To make estimating easier, break the wall up into sections of equal height, always maintaining one buried base course.
- > Will the wall be terraced? If so, the front of the upper wall must be at least 1.5 times the height of the lower wall behind the back of the base course of the lower wall.
- > What setback do you need? Some Permacon wall products are capable of achieving vertical walls and other products have an automatic setback. Vertical walls typically can't go as high as setback walls without geogrid reinforcement. In addition, setback walls may require less product. When planning and measuring, keep in mind that a single setback moves the top of the wall back 25 mm (1") per course from the front of the base course.

Walls that exceed the maximum recommended height, walls in areas of poor drainage and walls with extra loading at the top may require special engineering. Please contact Permacon for more information if your wall falls into one of these categories.

EXCAVATION & BASE PREPARATION

Set an excavation line using a chalk or string line. To create an accurate radius, drive a stake into the ground at the desired center of your project. Attach a string to the stake equal in length to the desired inside radius. Rotate the string to indicate the location of the back of the first course. Once laid out, excavate a trench equal to the depth of gravel material plus the height of one unit, or to firm soil. The trench should be approximately 100 to 150 mm - 4 to 6 in. wider than the wall block you have chosen.

After excavation, spread the base material uniformly throughout the trench with a hard toothed rake in layers of no more than 100 mm - 4in. Use the vibrating or hand tamper to compact the entire area evenly. Continue spreading and compacting base material until the desired depth is achieved and the surface has no low or high areas.

Place screed rails at the desired grade of the underside of the first course of wall. Level the screed rails with a 4 foot level or transit level. Place granular base material between the rails and screed level with a straight edge, such as a 2 x 4 timber. Compact this area with a hand tamper. After compacting, place more granular base material between the rails and screed level. This is the level surface for laying the wall base pieces.

BASE COURSE & WALL CONSTRUCTION

Start placing the base course on top of the compacted base, beginning at the lowest point of the wall. Check alignment and leveling as you proceed. Continue with additional courses, adding and compacting backfill material behind the wall after every second course. To ensure adequate interlock between courses, we recommend a minimum joint overlap of 1/4 bond.

To ensure proper color distribution, take pieces from several bundles at a time, removing them in stacks rather than by layer.

TIP: Check the levelness of the wall every 2-3 courses by putting a string line along the length of the wall.