

PERMACON



20
24



Greater Toronto Area

MASONRY PRODUCT DATA GUIDE
Stone Brick Alternative Masonry Accessories

Content

3	Introduction
4	Aria Stone
7	Dominion Stone
9	Lafitt Stone
11	Lafitt Alto Stone
14	Lamina Stone
17	Lexa Stone
19	Maestro Stone
21	Mondrian Stone
23	Colosseo Block <i>New</i>
25	Cardin Brick
27	Cinco Plus Brick
29	Cinco Plus Stone
31	Melville Norman Brick
33	Melville Slik Brick Accessories
35	Accessories
37	Suretouch Alternative Masonry - Durham Stone
39	Suretouch Alternative Masonry - Morency Stone
41	Suretouch Alternative Masonry - Virtuo Stone
43	Design Tools
44	Warranty

The purpose of this data guide is to provide product details, specifications and guidelines on best practices for specifying, ordering and installing Permacon Masonry Products.

These are just a few basic rules to help you successfully complete your masonry project.

For further technical information we suggest you consult the following sources: CSA Standards and Applicable Building Codes.

SUGGESTION # 1

Avoid boxes

When a group of stones forms a compartment (rectangle or square) it creates joints that should be broken. Adding a different dimension stone usually solves the problem. However, in some projects, such as small columns or pillars, it is difficult (or impossible) to avoid them.

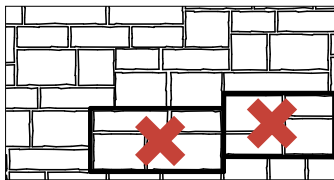

Avoid

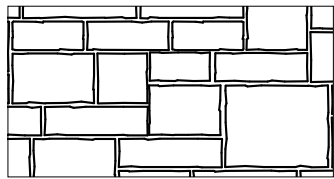

Good practice

SUGGESTION # 2

Avoid long vertical or horizontal joints

To maintain an aesthetic appearance of the wall, we suggest taking the height of the largest stone as the maximum reference for the vertical joints.

Concerning the length of the horizontal joints, they should be less than 4 feet long.

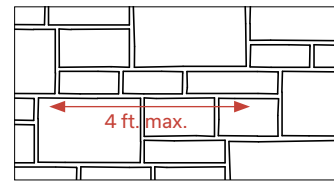
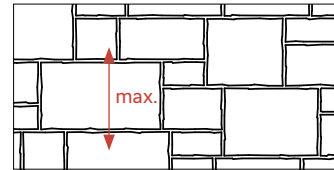

SUGGESTION # 3

Provide a minimum overlap of 4 inches

The minimum overlapping of the stone should be at least 4 inches.

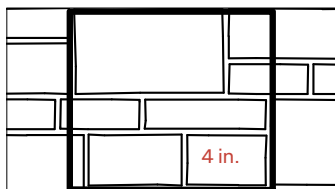

Please note all Permacon products are manufactured with natural ingredients like sand and stone, so it is normal that projects show variations in colour.



Aria Stone



- Allows for modular and linear installations
- Modular dimensions for reduced waste and easier installations
- Fully finished corners
- Perfect match to Melville pavers and slabs

	MIXED 3-HEIGHT	LARGE
Weight per cube (kg)	1508	1517
Rows per cube	7	7
Corner pieces	100%	100%
Sq.ft. per row	12.42	11.87
Sq.ft. per cube	86.94	83.09

A	90 mm x 60 mm x var.	3 1/2" x 2 3/8" x var.
B	90 mm x 102 mm x var.	3 1/2" x 4" x var.
C	90 mm x 172 mm x var.	3 1/2" x 6 3/4" x var.

For a complete list of dimensions go to permacon.ca

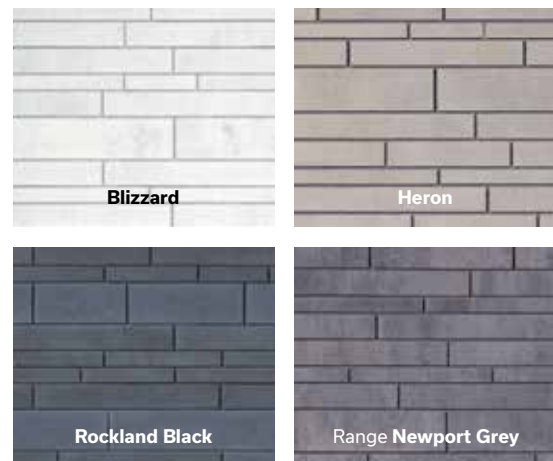

Units A, B and C are packaged together and available in all colours.

* Unit C is also packaged separately and available in Blizzard, Heron and Rockland Black.



Aria Stone - LARGE STONES

Suggested Laying Pattern:

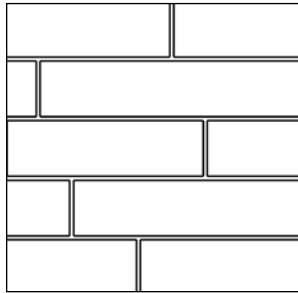

Linear

Typical Layout:

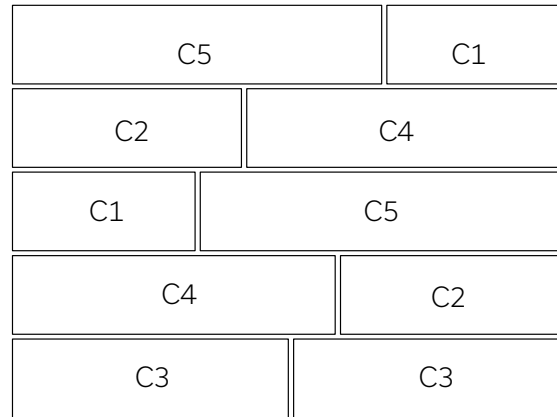

Large stones

Sizes - Stone Cladding:

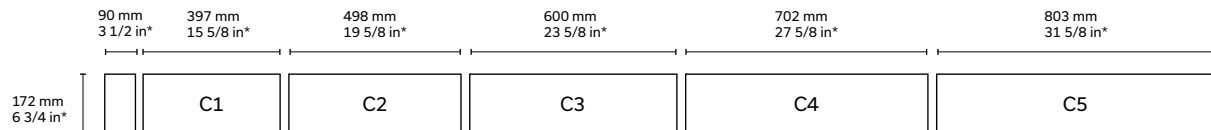

* Actual dimensions. Allow a 3/8 in. - 10 mm mortar joint in order to obtain nominal dimensions.
Note : Units (C1 to C5) are not sold individually. They are only sold as per the typical layout indicated.

Aria Stone - MIXED STONES

Suggested Laying Patterns::

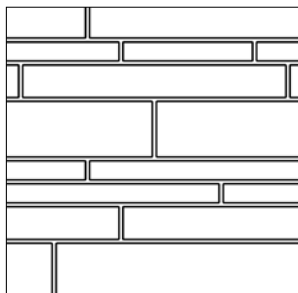

Random coursed

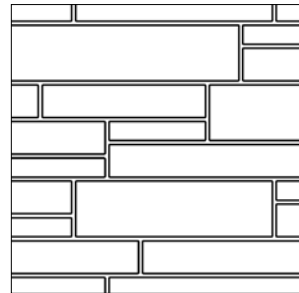

Ashlar pattern

Typical Layout:

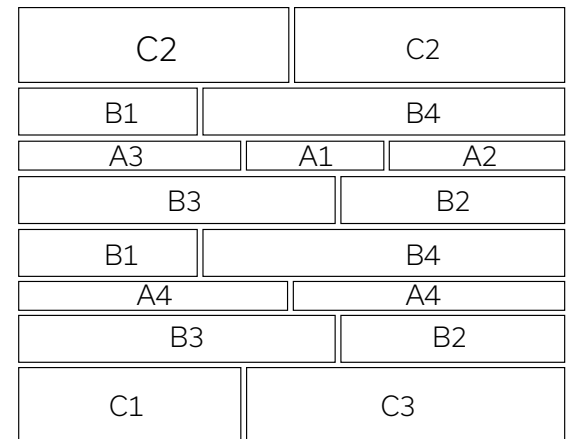

Mixed 3-height stones: small, medium and large

Sizes - Stone Cladding:

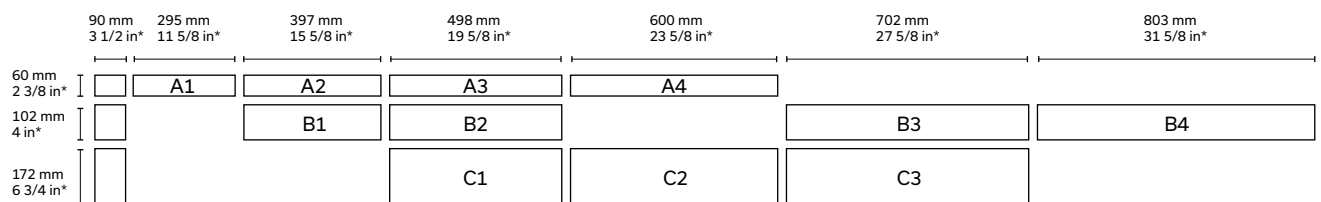

* Actual dimensions. Allow a 3/8 in. - 10 mm mortar joint in order to obtain nominal dimensions.
Note : Units (C1 to C5) are not sold individually. They are only sold as per the typical layout indicated.

Suggested Laying Patterns:

Random coursed

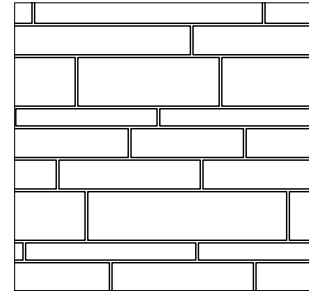
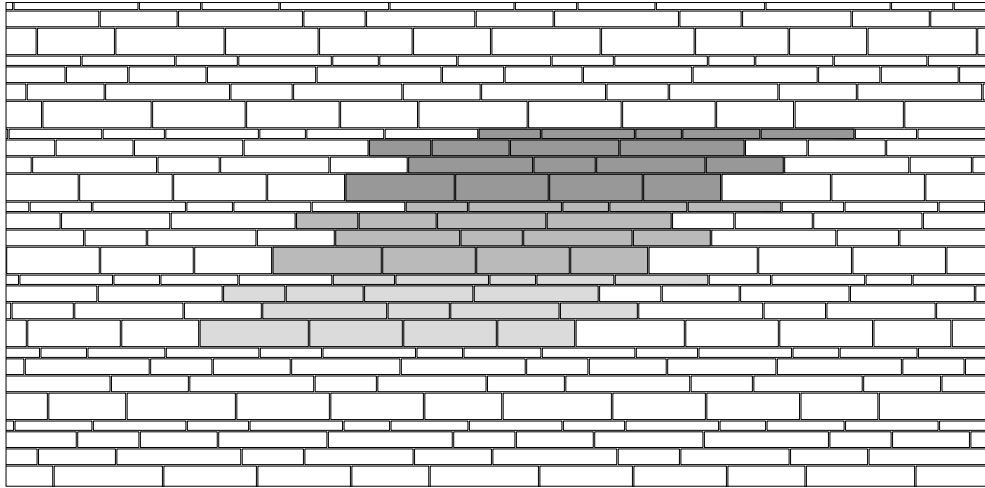

Modular

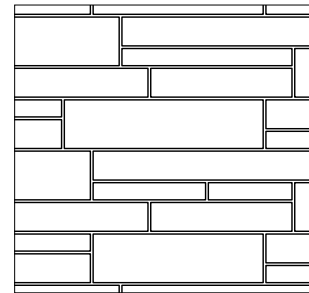
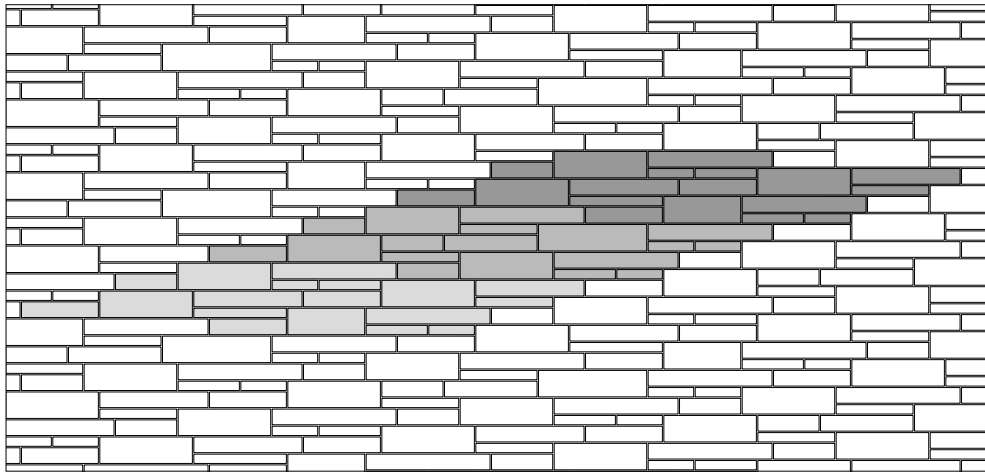

For information purposes only. The pattern should be adapted to the existing rows on the pallet when installed.

Technical information

Product	Standard	Compressive Strength	Density	Absorption	Dimension Tolerance	Fire Resistance (CNB)
Aria Stone	CSA A165.1	15 MPa	A : Over 2000 kg/m ³	A : 175 kg/m ³	Thickness: ±2.0 mm Height: ±2.0 mm Length: ±3.0 mm	1.39 hours



Dominion Stone

Enhances any project with its distinctive appearance and timeless appeal



	A	B	C
Weight per cube (kg)	1374	1386	1388
Rows per cube	8	8	7
Sq.ft. per row	10.33	10.33	11.63
Sq.ft. per cube	82.67	82.67	81.38
Corner pieces	100%	100%	100%
Lin. ft. per row	15.75	15.75	11.81
Lin. ft. per cube	126	126	82.68
Qty per cube	96 units	64 units	42 units

A	90 mm x 190 mm x 390 mm	3 1/2" x 7 1/2" x 15 3/8"
B	90 mm x 190 mm x 590 mm	3 1/2" x 7 1/2" x 23 1/4"
C	90 mm x 290 mm x 590 mm	3 1/2" x 11 7/16" x 23 1/4"

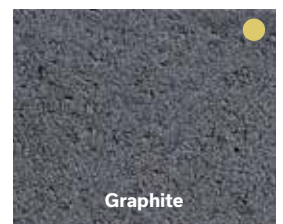
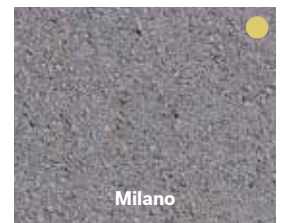
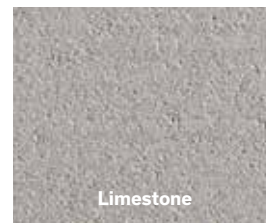

● Colours available for units B and C only



A (Sold separately)



B (Sold separately)



C (Sold separately)

Laying Patterns:

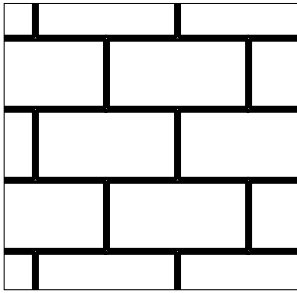

Linear - 8 in. x 16 in.

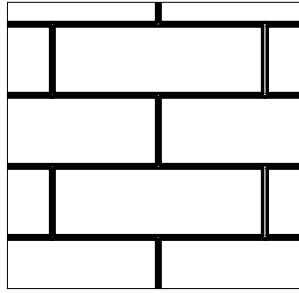

Linear - 8 in. x 24 in.

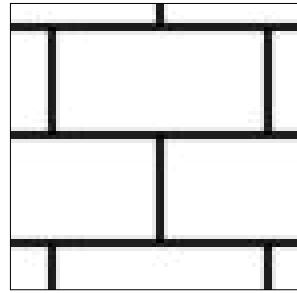

Linear - 12 in. x 24 in.

IMPORTANT NOTICE AVIS IMPORTANT

PIERRE **DOMINION** STONE

CAUTION

Top face = Install face

Packaged lying down, finished face upwards
This unit is not reversible

ATTENTION

Face supérieure = Face visible

Palettisée couchée, face visible vers le haut
Cette pierre est non réversible

INSTALL FACE - FACE VISIBLE

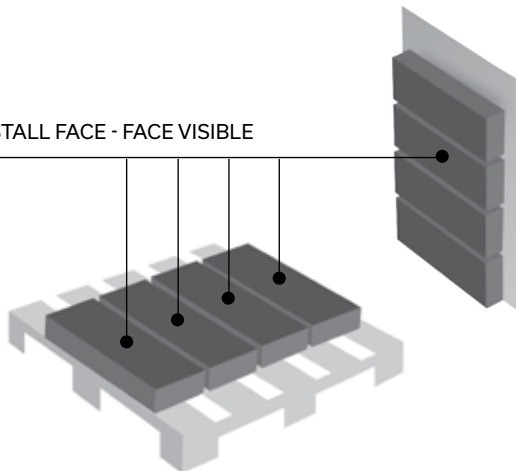

Technical information

Product	Standard	Compressive Strength	Density	Absorption	Dimension Tolerance	Fire Resistance (CNB)
Dominion Stone	CSA A165.1	15 MPa	A : Over 2000 kg/m ³	A : 175 kg/m ³	Thickness: ±2.0 mm Height: ±2.0 mm Length: ±3.0 mm	1.39 hours



Lafitt Stone



- Unique pigmentation process, resulting in a product that maintains its colour year after year
- Total design freedom: choice of large stone ratios; choice of stone ratios with enhanced texture; choice of colour ranges (elemental and duos)
- Modular formats = less cutting and waste = material savings

	SMALL-MEDIUM	LARGE
Weight per cube (kg)	1553	1453
Rows per cube	7	7
Corner pieces	100%	100%
Sq.ft. per row	12.96	11.49
Sq.ft. per cube	90.86	80.43

A	90 mm x 102 mm x var.	3 1/2" x 4" x var.
B	90 mm x 178 mm x var.	3 1/2" x 7" x var.
C	90 mm x 292 mm x var.	3 1/2" x 11 1/2" x var.

For a complete list of dimensions go to permacon.ca

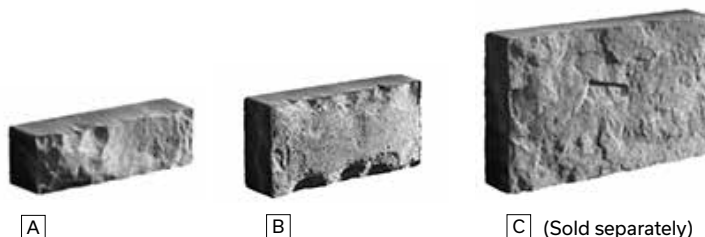

Laying Patterns:

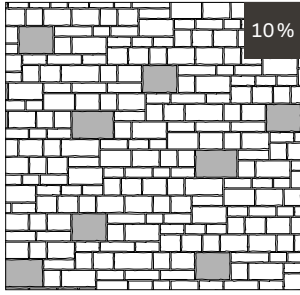

9 cubes of 4 in. (102 mm) and 7 in. (178 mm) for 1 cube of 11 1/2 in. (292 mm)

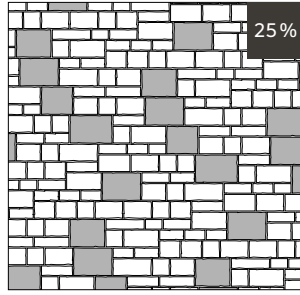

3 cubes of 4 in. (102 mm) and 7 in. (178 mm) for 1 cube of 11 1/2 in. (292 mm)

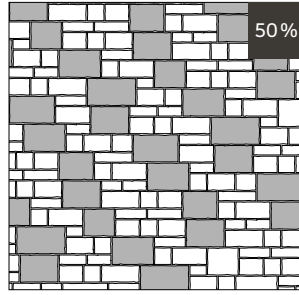

1 cube of 4 in. (102 mm) and 7 in. (178 mm) for 1 cube of 11 1/2 in. (292 mm)

Typical Rows:

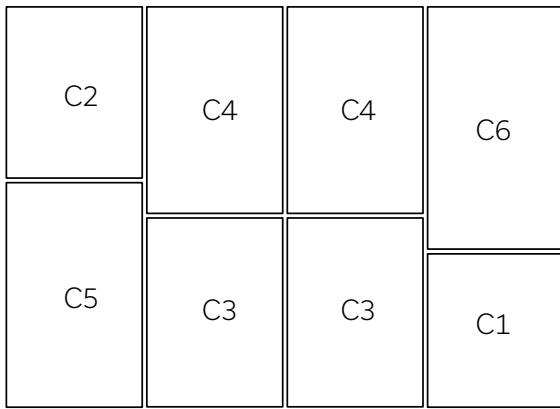

Large stones

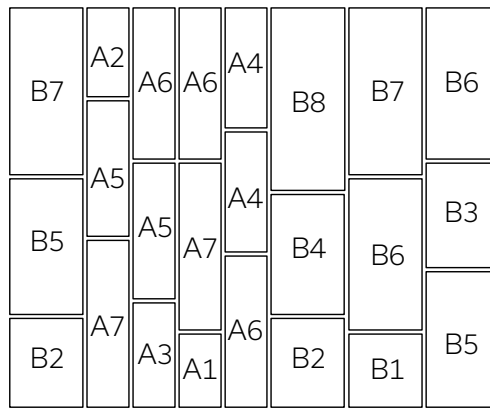

Small and medium stones

Sizes - Stone Cladding:

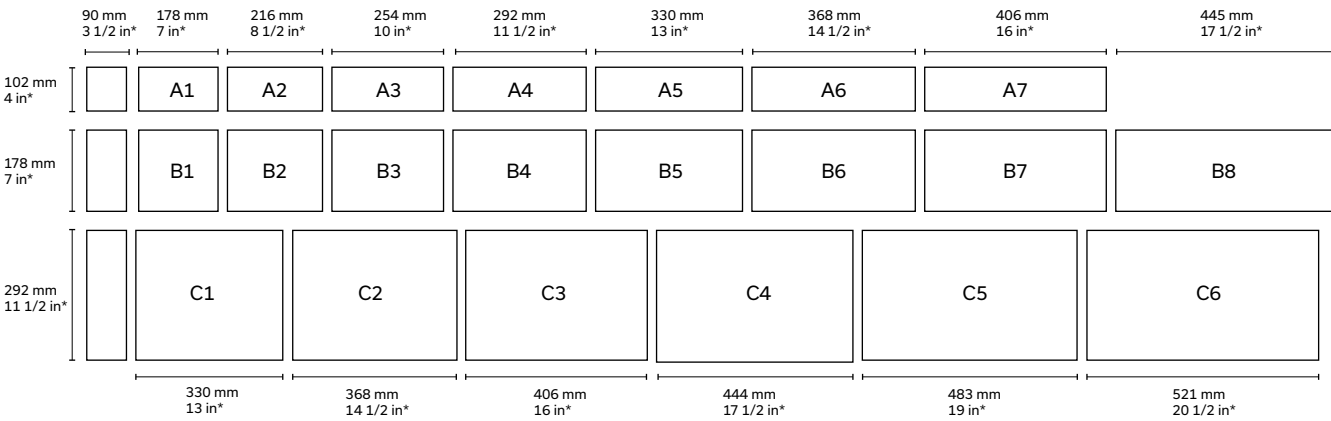

* Actual dimensions. Allow a 1/2 in. - 13 mm mortar joint in order to obtain nominal dimensions.

Technical information

Product	Standard	Compressive Strength	Density	Absorption	Dimension Tolerance	Fire Resistance (CNB)
Lafitt Stone	CSA A165.1	15 MPa	A : Over 2000 kg/m ³	A : 175 kg/m ³	Thickness: ±2.0 mm Height: ±2.0 mm Length: ±3.0 mm	1.39 hours



Lafitt Alto Stone

- Unique pigmentation process, resulting in a product that maintains its colour year after year
- Total design freedom: choice of large stone ratios; choice of stone ratios with enhanced texture; choice of colour ranges (elemental and duos)
- Modular formats = less cutting and waste = material savings



	SMALL-MEDIUM	LARGE
Weight per cube (kg)	1615	1512
Rows per cube	7	7
Corner pieces	100%	100%
Sq.ft. per row	12.98	11.49
Sq.ft. per cube	90.86	80.43

A	90 mm x 102 mm x var.	3 1/2" x 4" x var.
B	90 mm x 178 mm x var.	3 1/2" x 7" x var.
C	90 mm x 292 mm x var.	3 1/2" x 11 1/2" x var.

For a complete list of dimensions go to permacon.ca



[A]



[B]



[C] (Sold separately)

Laying Patterns:

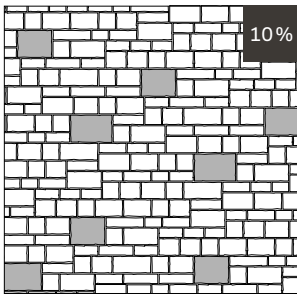

9 cubes of 4 in. (102 mm) and 7 in. (178 mm) for 1 cube of 11 1/2 in. (292 mm)

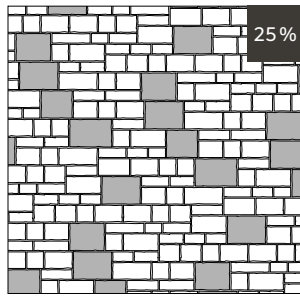

3 cubes of 4 in. (102 mm) and 7 in. (178 mm) for 1 cube of 11 1/2 in. (292 mm)

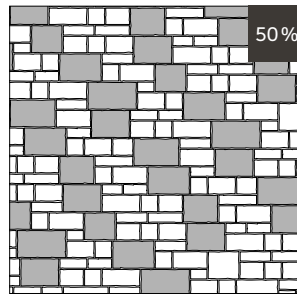

1 cube of 4 in. (102 mm) and 7 in. (178 mm) for 1 cube of 11 1/2 in. (292 mm)

Typical Rows:

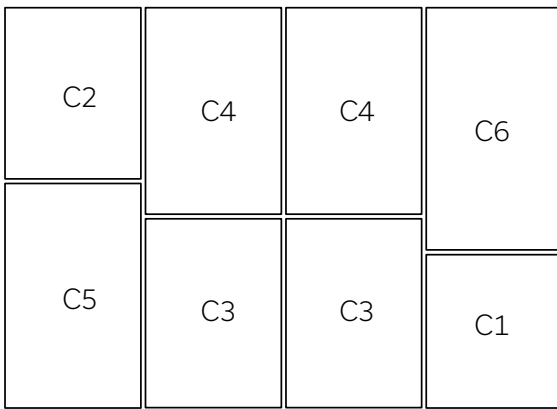

Large stones

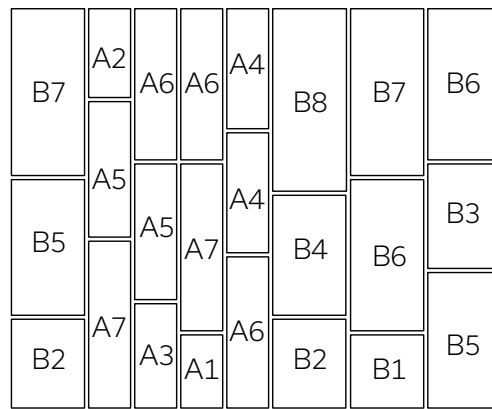

Small and medium stones

Sizes - Stone Cladding:

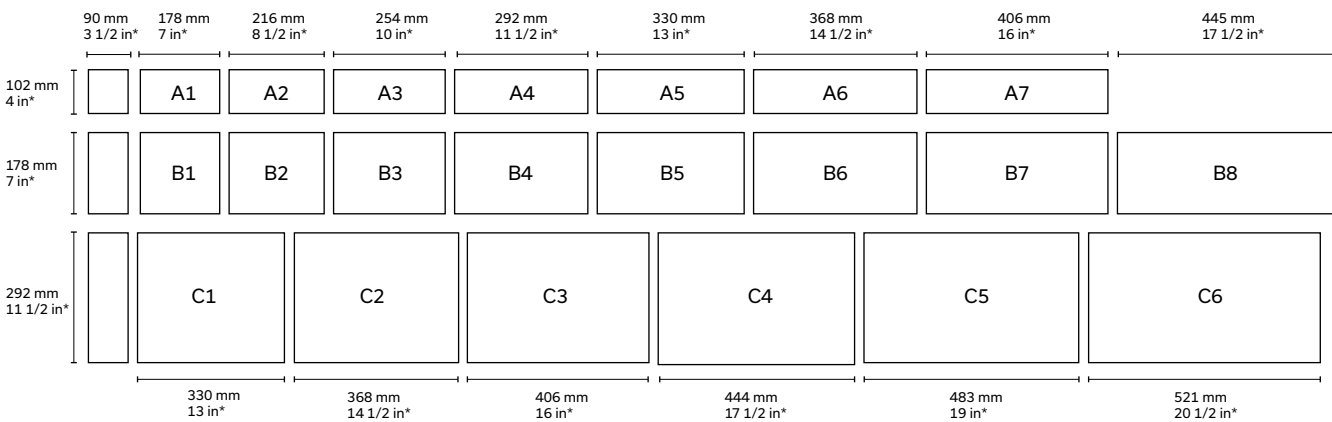

* Actual dimensions. Allow a 1/2 in. - 13 mm mortar joint in order to obtain nominal dimensions.

Technical information

Product	Standard	Compressive Strength	Density	Absorption	Dimension Tolerance	Fire Resistance (CNB)
Lafitt Alto Stone	CSA A165.1	15 MPa	A : Over 2000 kg/m ³	A : 175 kg/m ³	Thickness: ±2.0 mm Height: ±2.0 mm Length: ±3.0 mm	1.39 hours



Colour Combinations



Lamina Stone

- A 90 mm thick stone veneer used in a conventional masonry manner
- Easy to install due to its unique single height and its four different lengths
- Fewer cuts and waste onsite thanks to its modularity



Weight per cube (kg)	1309
Rows per cube	8
Corner pieces	40% - 26 ft vertical
Sq.ft. per row	9.97
Sq.ft. per cube	79.76

90 mm x 95 mm x var. 3 1/2" x 3 3/4" x var.

For a complete list of dimensions go to permacon.ca



Range Margaux Beige



Range Newport Grey



Rockland Black



Lamina Stone

Laying Pattern:

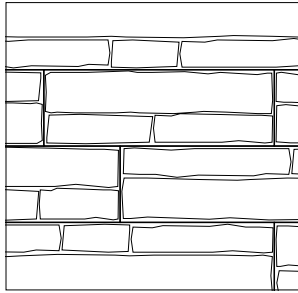

Typical Row:

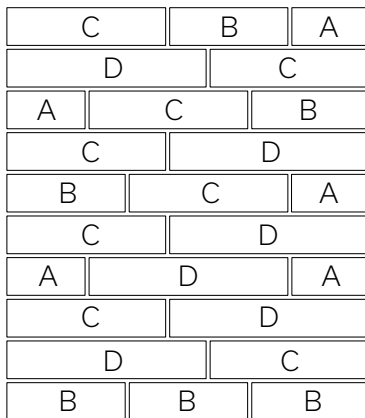

Sizes - Stone Cladding:

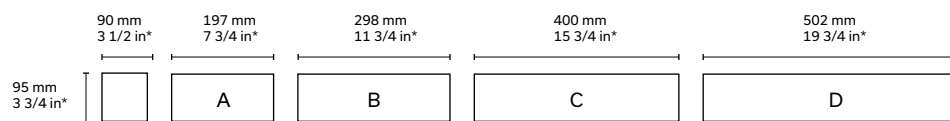

* Actual dimensions: allow a 1/4 in. - 6mm mortar joint in order to obtain nominal dimensions. Lamina stone is offered in a finish that provides the appearance of stacked stones embellished throughout the years. It is completely normal that some stones present a small amount of softer edges and rounded corners.

Technical information

Product	Standard	Compressive Strength	Density	Absorption	Dimension Tolerance	Fire Resistance (CNB)
Lamina Stone	CSA A165.1	15 MPa	A : Over 2000 kg/m ³	A : 175 kg/m ³	Thickness: ±2.0 mm Height: ±2.0 mm Length: ±3.0 mm	1.39 hours

Lamina Stone

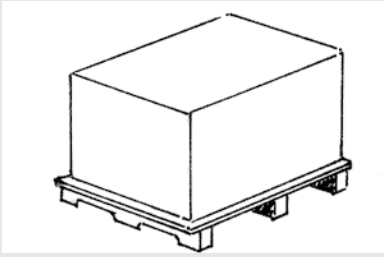

You will notice that the cubes come with all four units of Lamina stone.

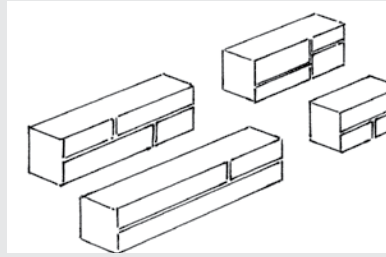

All of the stones measure 90 mm (3 1/2 in.) in actual depth and 95.25 mm (3 3/4 in.) in actual height for an easy installation.

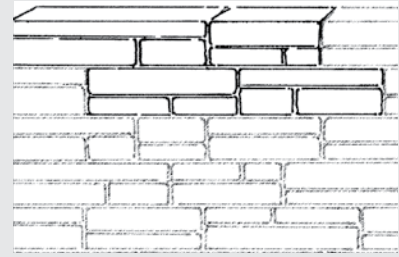

Lamina stone is installed like any other masonry veneer. The units should be installed randomly.

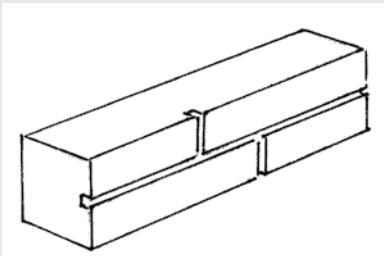

Each stone has different reliefs. This should be taken into consideration when installing the stone.



We suggest the use of mortar in its natural colour so that it can easily blend into the stone colours. We advise using a thin jointing tool to achieve a 6 mm (1/4 in.) thick joint.

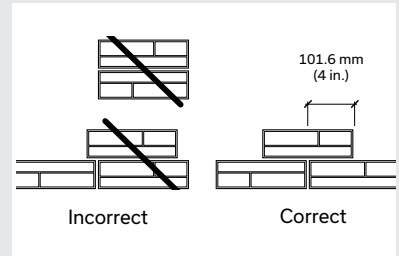

The selection of each stone needs to be as random in length and texture as possible to achieve a more natural look and feel. Avoid creating "boxes" while installing, by overlapping the stones at least 101.6 mm (4 in.) to obtain the best interlocking results.

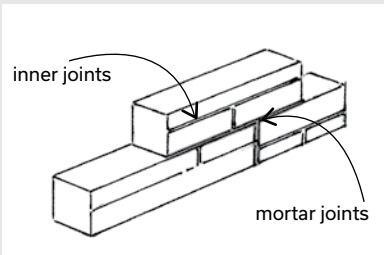

Identify the "mortar joints" and the "inner joints". The basic principle would be to have the "mortar joints" and "inner joints" as similar in thickness as possible.

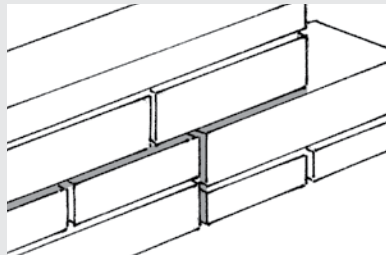

Try to achieve a "mortar joint" of approximately 6 mm (1/4 in.) thick so that you can obtain an equal appearance throughout the stones.

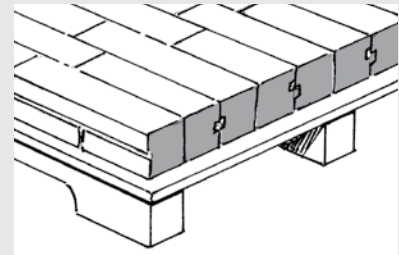

Forty percent (40% or 26 vertical feet) of the stones have a textured end to easily achieve corners. They are easily identifiable, always located on one side of a row on the cube.

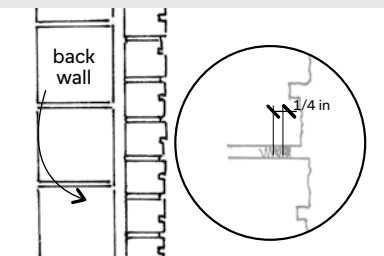

Leave a recessed joint of 6 mm (1/4 in.) deep compared to the deepest stone, so that all joints appear equal.

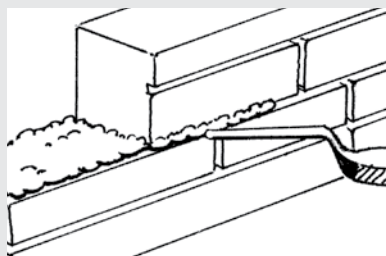

In order to make sure that all the mortar joints have the same colour, tool them when they have the same firmness. It should be noted that the firmer the joints, the darker the colour will be when tooled.



Once the installation is complete, clean the wall thoroughly with a stiff brush in order to remove any excess mortar. Remove any residue in the "inner joint" with a trowel, a thin jointing tool or any other similar tool. Leave wall to dry for approximately 24 hours or until completely dry. Wash with any stone or masonry cleaner recommended by Permacon. Repeat this last step as needed.



Lexa Stone



- Allows for a modular or linear installation
- Reduces the number of cuts required and waste due to its modular dimensions
- Presents chamfered edges to accentuate clean lines
- Includes a percentage of stones with finished ends to achieve corners

	Alpine Grey and Cameo Beige		Rockland Black	
	SMALL-MEDIUM	LARGE	SMALL-MEDIUM	LARGE
Weight per cube (kg)	1489	1489	2061	2061
Rows per cube	8	8	8	8
Sq.ft. per row	10.53	10.53	10.53	10.53
Sq.ft. per cube	84.24	84.24	84.24	84.24
Corner pieces	50% - 21 ft. vertical	50% - 21 ft. vertical	50% - 21 ft. vertical	50% - 21 ft. vertical
Lin. ft. per row	31	15.50	31	15.50
Lin. ft. per cube	245	124	245	124
Qty per cube	128 units	64 units	128 units	64 units

A	90 mm x 76 mm x var.	3 1/2" x 3" x var.
B	90 mm x 114 mm x var.	3 1/2" x 4 1/2" x var.
C	90 mm x 198 mm x var.	3 1/2" x 7 13/16" x var.

For a complete list of dimensions go to permacon.ca

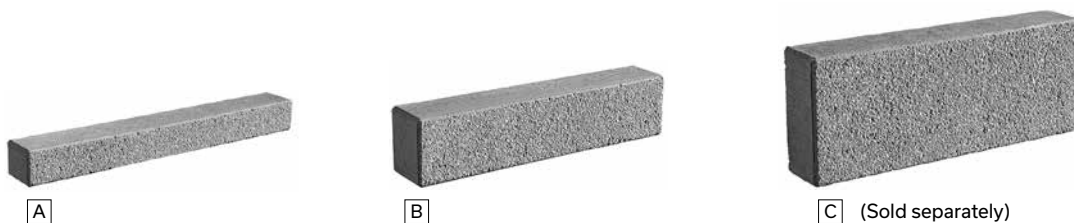
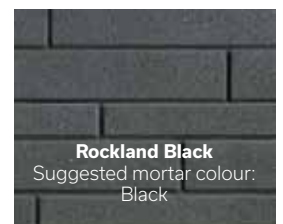
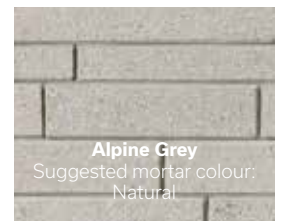

Laying Patterns:

Choice of large stones of 7 13/16 in. - 198 mm

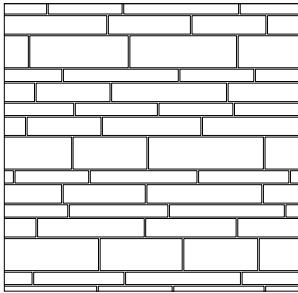

1 cube larges stones + 2 cubes small and medium stones - linear

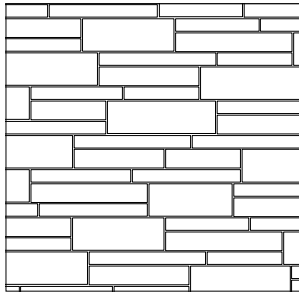

1 cube larges stones + 2 cubes small and medium stones - modular

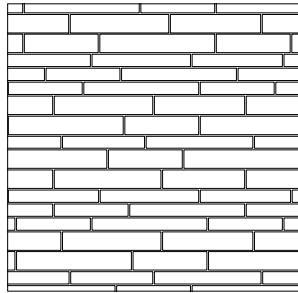

1 cube small and medium stones - linear

Typical Rows:

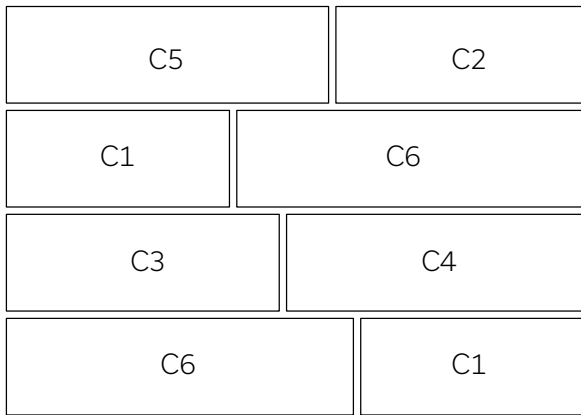

Large stones

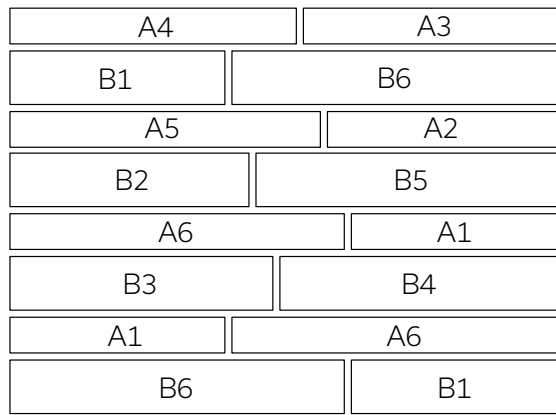

Small and medium stones

Sizes - Stone Cladding:

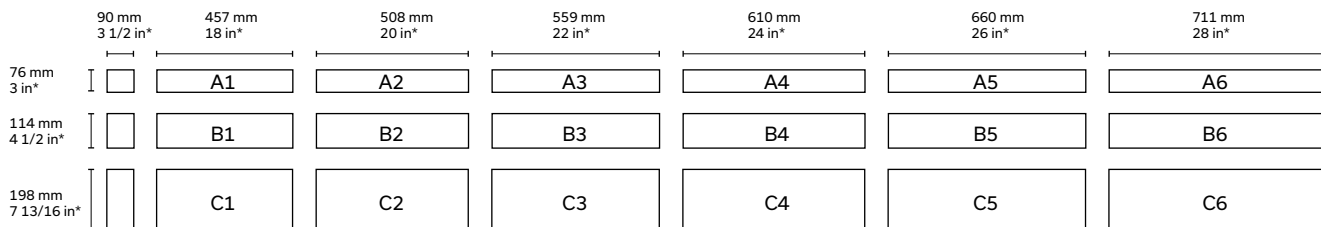

* Actual dimensions. Allow a 1/3 in. - 8 mm mortar joint in order to obtain nominal dimensions.

Technical information

Product	Standard	Compressive Strength	Density	Absorption	Dimension Tolerance	Fire Resistance (CNB)
Lexa Stone	CSA A165.1	15 MPa	A : Over 2000 kg/m ³	A : 175 kg/m ³	Thickness: ±2.0 mm Height: ±2.0 mm Length: ±3.0 mm	1.39 hours



Maestro Stone



- Fully finished corners
- Perfect match to Melville pavers and slabs

Weight per cube (kg)	1256
Rows per cube	8
Sq.ft. per row	8.72
Sq.ft. per cube	69.76
Corner pieces	100%
Lin. ft. per row	26.28
Lin. ft. per cube	210.24
Qty per cube	72 units
90 mm x 90 mm x 890 mm	3 1/2" x 3 1/2" x 35"

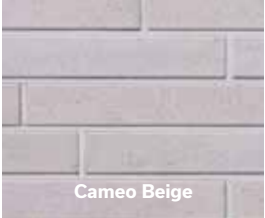

Laying Pattern:

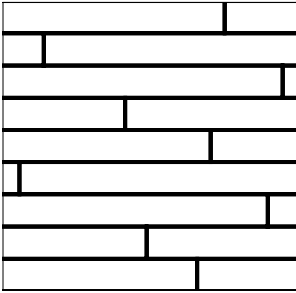

Linear

Typical Layout:

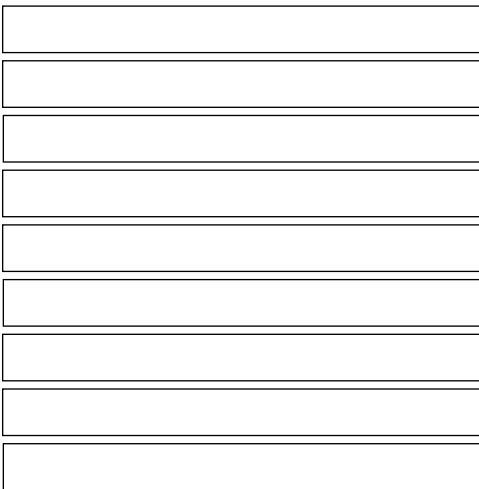

Sizes - Stone Cladding:

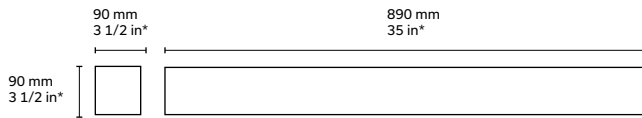

* Actual dimensions. Allow a 3/8 in. - 10 mm mortar joint in order to obtain nominal dimensions.

Technical information

Product	Standard	Compressive Strength	Density	Absorption	Dimension Tolerance	Fire Resistance (CNB)
Maestro Stone	CSA A165.1	15 MPa	A : Over 2000 kg/m ³	A : 175 kg/m ³	Thickness: ±2.0 mm Height: ±2.0 mm Length: ±3.0 mm	1.39 hours



Mondrian Stone



- Allows for a modular or linear installation
- Reduces the number of cuts required and waste due to its modular dimensions
- Matches perfectly with our landscaping products, including Trafalgar pavers, Mondrian Plus pavers and slabs

	SMALL-MEDIUM	LARGE
Weight per cube (kg)	1595	1595
Rows per cube	8	8
Sq.ft. per row	10.53	10.53
Sq.ft. per cube	84.24	84.24
Corner pieces	100%	100%
Lin. ft. per row	31	15.50
Lin. ft. per cube	248	124
Qty per cube	128 units	64 units

A	90 mm x 76 mm x var.	3 1/2" x 3" x var.
B	90 mm x 114 mm x var.	3 1/2" x 4 1/2" x var.
C	90 mm x 198 mm x var.	3 1/2" x 7 13/16" x var.

Formats available in Ontario (with the exception of Ottawa)

For a complete list of dimensions go to permacon.ca



A



B



C (Sold separately)



Blizzard



Range Amber Beige



Range Margaux Beige



Range Scandina Grey



Range Newport Grey

Mondrian Stone

Laying Patterns:

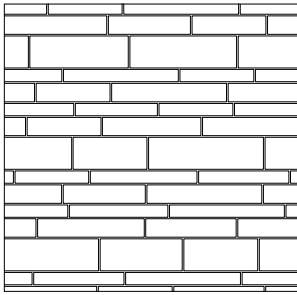

1 cube large stones +
2 cubes small and medium
stones - linear

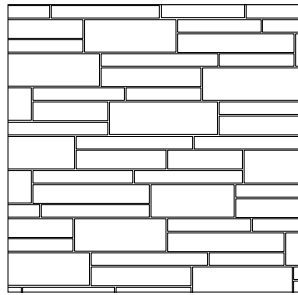

1 cube large stones +
2 cubes small and medium
stones - modular

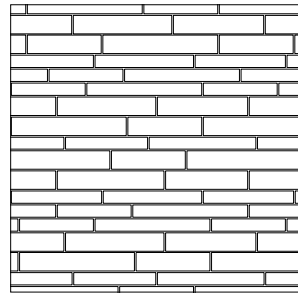

1 cube small and medium stones-
linear

Typical Rows:

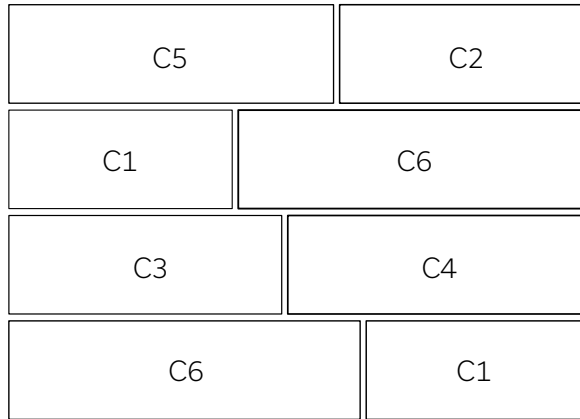

Large stones

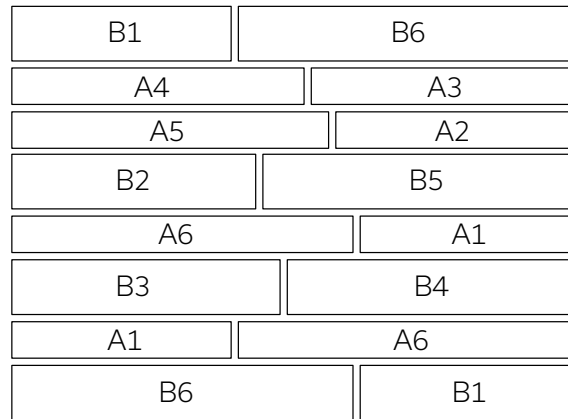

Small and medium stones

Sizes - Stone Cladding:

	90 mm 3 1/2 in*	457 mm 18 in*	508 mm 20 in*	559 mm 22 in*	610 mm 24 in*	660 mm 26 in*	711 mm 28 in*
76 mm 3 in*	A1	A2	A3	A4	A5	A6	
114 mm 4 1/2 in*	B1	B2	B3	B4	B5	B6	
198 mm 7 13/16 in*	C1	C2	C3	C4	C5	C6	

* Actual dimensions. Allow a 1/3 in. - 8 mm mortar joint in order to obtain nominal dimensions.

Technical information

Product	Standard	Compressive Strength	Density	Absorption	Dimension Tolerance	Fire Resistance (CNB)
Mondrian Stone	CSA A165.1	15 MPa	A : Over 2000 kg/m ³	A : 175 kg/m ³	Thickness: ±2.0 mm Height: ±2.0 mm Length: ±3.0 mm	1.39 hours



New Colosseo Block



- Two choices of sizing, both with an architectural bloc look and finished corners on all units
- Smooth texture on both faces—can be installed on either side
- Cored block, which provides increased adhesion to mortar and eases the installation (lighter units)
- Ideal for institutional, commercial, industrial projects that require fast and economical installation



Optra

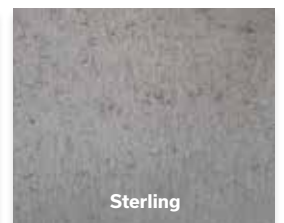

Sterling



Charcoal

	A	B
Weight per cube (kg)	1 404	2 132
Rows per cube	5	4
Sq.ft. per row	19.14	19.31
Sq.ft. per cube	95.72	77.24
Corner pieces	100%	100%
Lin. ft. per row	30.71	30.97
Lin. ft. per cube	153.54	123.88
Qty per cube	120 units	64 units

A	90 mm x 190 mm x 390 mm	4" x 8" x 16"
B	90 mm x 190 mm x 590 mm	4" x 8" x 24"

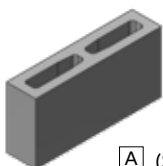

A (Sold separately)

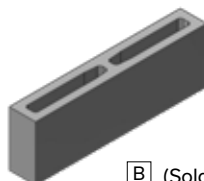

B (Sold separately)

Laying Patterns:

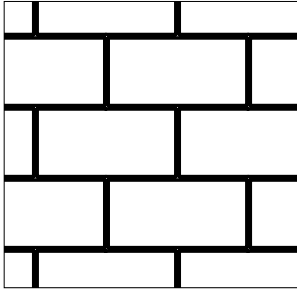

Running Bond - 8 in. x 16 in.

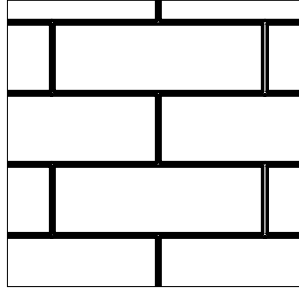

Running Bond - 8 in. x 24 in.

Typical Rows:

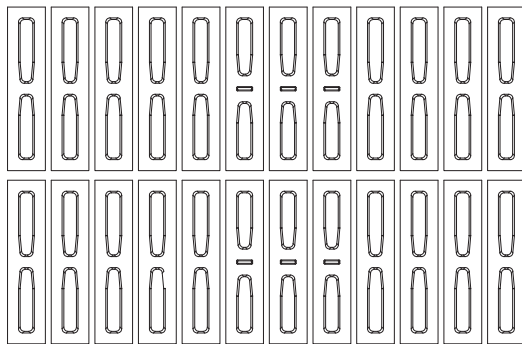

8 x 16

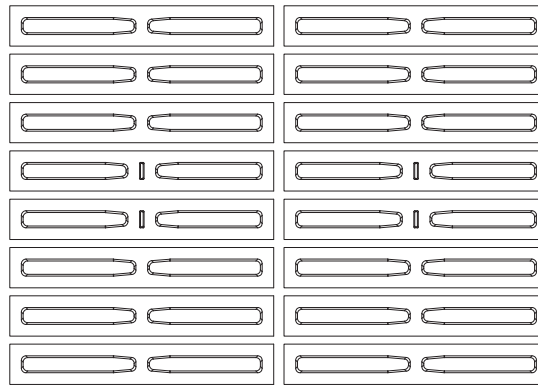

8 x 24

Technical information

Product	Standard	Compressive Strength	Density	Absorption	Dimension Tolerance	Fire Resistance (CNB)
Colosseo Block 8 x 16	CSA A165.1	15 MPa	A : Over 2000 kg/m ³	A : 175 kg/m ³	Thickness: ±2.0 mm Height: ±2.0 mm Length: ±3.0 mm	0.80 hours
Colosseo Block 8 x 24	CSA A165.1	15 MPa	A : Over 2000 kg/m ³	A : 175 kg/m ³	Thickness: ±2.0 mm Height: ±2.0 mm Length: ±3.0 mm	0.80 hours



Cardin Brick

- Size lowers overall costs (materials and installation)
- Uniform distribution of pigments throughout the brick that preserve their colour year after year rather than just on the surface

Weight per cube (kg)	1450
Rows per cube	8
Sq.ft. per row	11.25
Sq.ft. per cube	90.01
Coverage	3.9 bricks
Qty per cube	352 bricks
90 mm x 79 mm x 257 mm	3 1/2" x 3 1/8" x 10 1/8"



Laying Pattern:

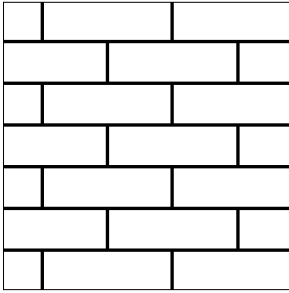

1/2 Running Bond

Typical Layout:

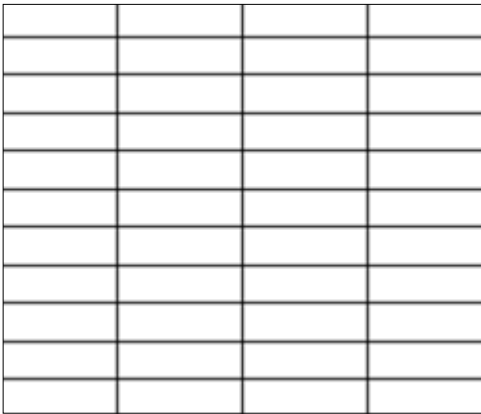

Format

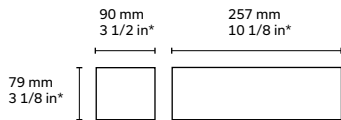

* Actual dimensions. Allow a 3/8 in. - 10 mm mortar joint in order to obtain nominal dimensions.

Technical information

Product	Standard	Compressive Strength	Density	Absorption	Dimension Tolerance	Fire Resistance (CNB)
Cardin Brick	CSA A165.2	25 MPa	> 2000 kg/m ³	8%	Thickness: ±2.0 mm Height: ±2.0 mm Length: ±2.0 mm	1.39 hours



Cinco Plus Brick



- Harmonizes perfectly with stone, especially Lafitt stone, thanks to its multiple lengths, texture and colours
- Installs similar to brick so costs are reduced compared to stone

Weight per cube (kg)	1480
Rows per cube	7
Corner pieces	58%
Sq.ft. per row	12.67
Sq.ft. per cube	88.69
Coverage	3.2 bricks (average)

90 mm x 92 mm x var. 3 1/2" x 3 5/8" x var.

For a complete list of dimensions go to permacon.ca

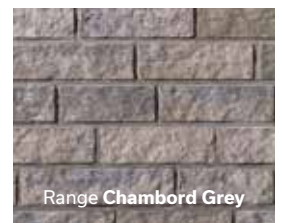

* Range Grey and Black, Range Lennox Grey and Rockland Black are not available in the Greater Toronto Area

Laying Pattern:

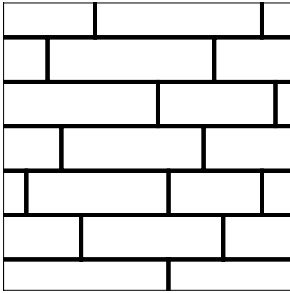

Linear

Typical Layout:

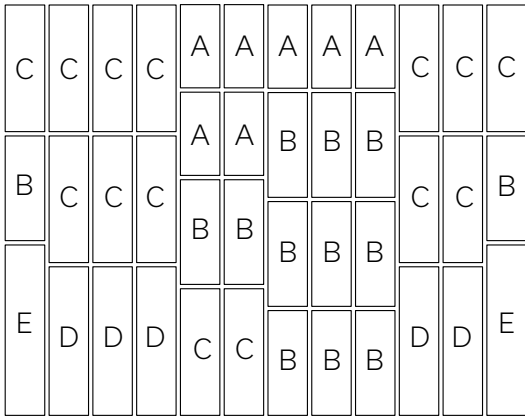

Formats:

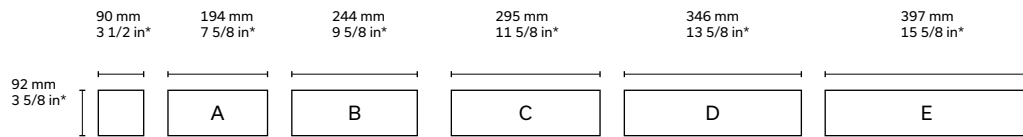

* Actual dimensions. Allow a 3/8 in. - 10 mm mortar joint in order to obtain nominal dimensions.

Technical information

Product	Standard	Compressive Strength	Density	Absorption	Dimension Tolerance	Fire Resistance (CNB)
Cinco Plus Brick	CSA A165.2	25 MPa	> 2000 kg/m ³	8%	Thickness: ±2.0 mm Height: ±2.0 mm Length: ±2.0 mm	1.39 hours



Cinco Plus Stone

- Versatile: use alone or with Cinco brick
- Cost effective (installs like a brick)
- Unique look that is part brick, part stone

Weight per cube (kg)	1436
Rows per cube	7
Corner pieces	86%
Sq.ft. per row	12.29
Sq.ft. per cube	86.03

90 mm x 196 mm x var. 3 1/2" x 7 23/32" x var.

For a complete list of dimensions go to permacon.ca



Cinco Plus Stone

Laying Patterns:

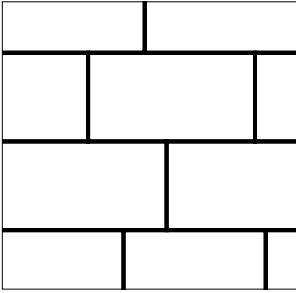

Cinco Stone linear

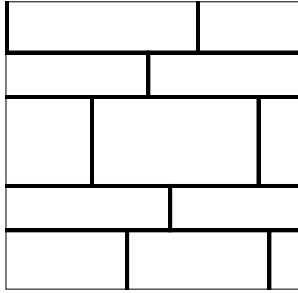

Cinco Stone and Cinco Brick linear

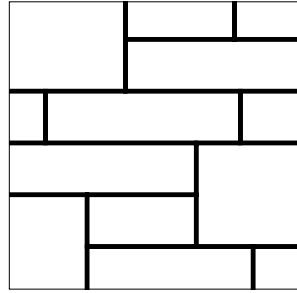

Cinco Stone and Cinco Brick modular

Typical Layout:

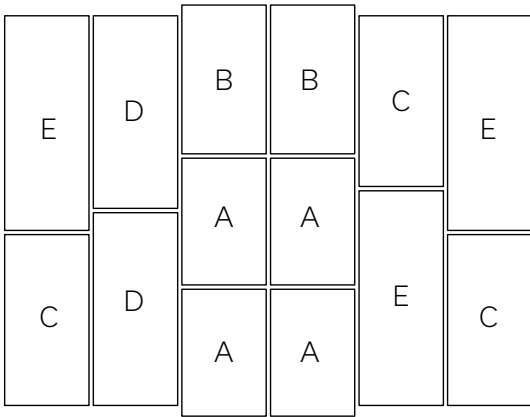

Formats:

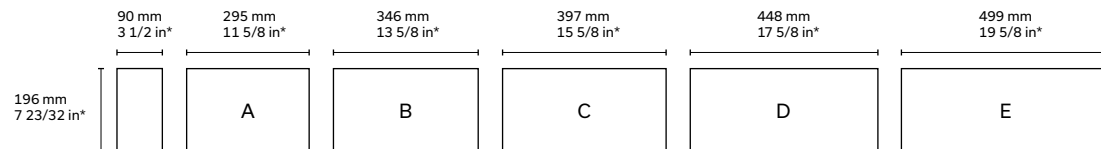

* Actual dimensions. Allow a 3/8 in. - 10 mm mortar joint in order to obtain nominal dimensions.

Technical information

Product	Standard	Compressive Strength	Density	Absorption	Dimension Tolerance	Fire Resistance (CNB)
Cinco Plus Stone	CSA A165.1	15 MPa	A : Over 2000 kg/m ³	A : 175 kg/m ³	Thickness: ±2.0 mm Height: ±2.0 mm Length: ±3.0 mm	1.39 hours



Melville Norman Brick



- Manufacturing process offers unparalleled dimensional stability to the brick
- Laying with 1/3 running bond pattern avoids cutting bricks at the corner for a more efficient installation
- Uniform distribution of pigments throughout the bricks that preserve their colour year after year rather than just on the surface

Weight per cube (kg)	1270
Rows per cube	12
Sq.ft. per row	7.79
Sq.ft. per cube	93.49
Coverage	4.6
Qty per cube	432 bricks
<hr/>	
90 mm x 57 mm x 290 mm	3 1/2" x 2 1/4" x 11 7/16"



Laying Patterns:

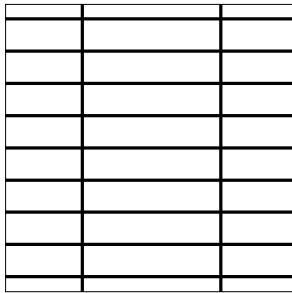

Linear

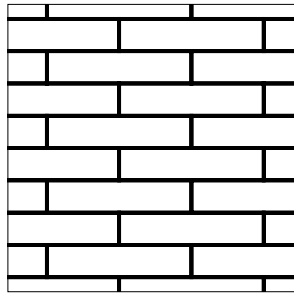

1/2 Running Bond

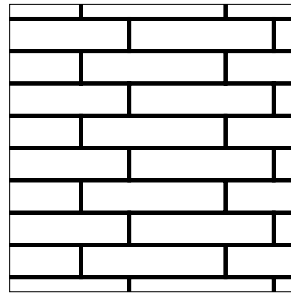

1/3 Running Bond

Typical Layout:

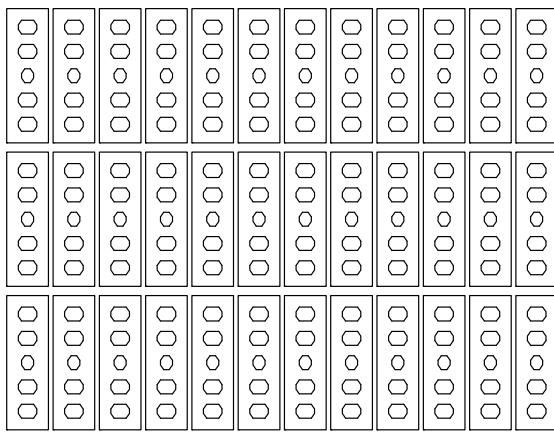

Format:

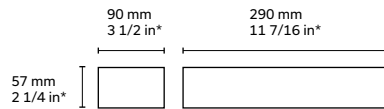

* Actual dimensions. Allow a 3/8 in. - 10 mm mortar joint in order to obtain nominal dimensions.

Technical information

Product	Standard	Compressive Strength	Density	Absorption	Dimension Tolerance	Fire Resistance (CNB)
Melville Norman Brick	CSA A165.2	20 MPa	> 2000 kg/m ³	8%	Thickness: ±2.0 mm Height: ±2.0 mm Length: ±2.0 mm	0.96 hour



Melville Slik Brick



- Size lowers overall costs (materials and installation)
- Cored brick make it easier to install and provide increased adhesion to mortar
- Double sided and colour throughout

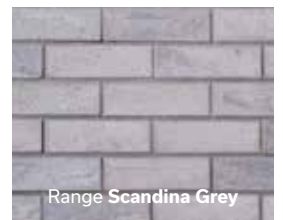

A	90 mm x 79 mm x 257 mm	3 1/2" x 3 1/8" x 10 1/8"
B	90 mm x 79 mm x 257 / 212 mm	3 1/2" x 3 1/8" x 10 1/8" / 8 3/8"



Melville Slik Brick

	Mtl/St-Eustache/Qc/Bolton	Metcalfe
Weight per cube (kg)	1456	1213
Rows per cube	12	10
Sq.ft. per row	9.21	9.21
Sq.ft. per cube	110.47	92.1
Coverage	3.9 bricks	3.9 bricks
Qty per cube	432 bricks	360 bricks

Laying Pattern:

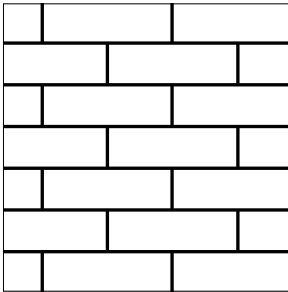

1/2 Running Bond

Typical Layout:

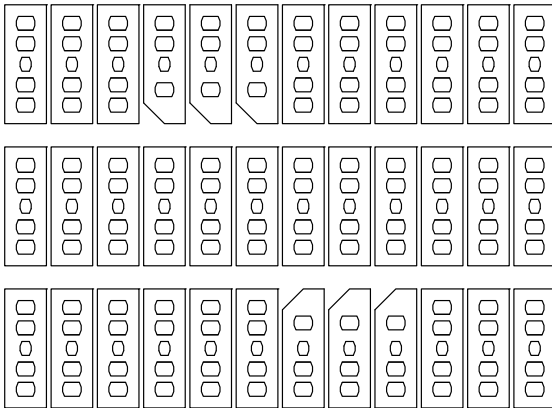

Formats:

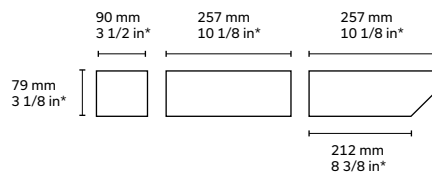

* Actual dimensions. Allow a 3/8 in. - 10 mm mortar joint in order to obtain nominal dimensions.

Technical information

Product	Standard	Compressive Strength	Density	Absorption	Dimension Tolerance	Fire Resistance (CNB)
Melville Slik Brick	CSA A165.2	20 MPa	> 2000 kg/m ³	8 %	Thickness: ±2.0 mm Height: ±2.0 mm Length: ±2.0 mm	1,00 hour



Accessories

- Savings on material thanks to longer sills, means less joints and less cuts
- High density concrete makes it more durable
- Flexibility and innovation in the design thanks to its chiselled and smooth finishes
- Choice of colours that can easily be matched with all products
- The sill matches the height of a max size brick (3.9 bricks/square foot) such as Melville Slik Brick and Cardin Brick

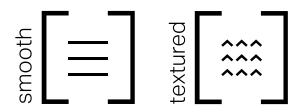

Dominion Jamb and Reversible Window Sill

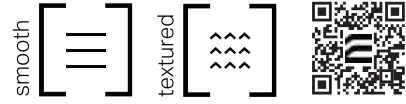

Reversible Dominion Window Sill

Weight per cube (kg)	1471
Rows per cube	8
Qty per cube (unit)	64

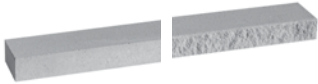

145 mm x 75 mm x 914 mm	5 11/16" x 3" x 36"
-------------------------	---------------------

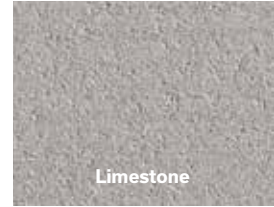

Dominion Jamb *New*

Weight per cube (kg)	1659
Rows per cube	7
Qty per cube (unit)	56



89 mm x 254 mm x 610 mm	3 1/2" x 10" x 24"
-------------------------	--------------------

Cardiff Window Sill

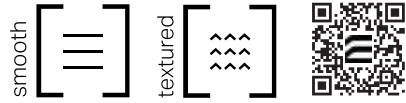

Smooth

Weight per cube (kg)	1253
Rows per cube	4
Qty per cube (unit)	48



150 mm x 79 mm x 948 mm	5 7/8" x 3 1/8" x 37 3/8"
-------------------------	---------------------------

Chiselled

Weight per cube (kg)	1374
Rows per cube	4
Qty per cube (unit)	48



150 mm x 79 mm x 948 mm	5 7/8" x 3 1/8" x 37 3/8"
-------------------------	---------------------------





Suretouch Durham Stone

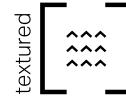

A key feature is its rustic texture inspired by the French country manor.

Weight per cube (kg)	1415
Rows per cube	12
Sq.ft. per row	12.43
Sq.ft. per cube	149.16

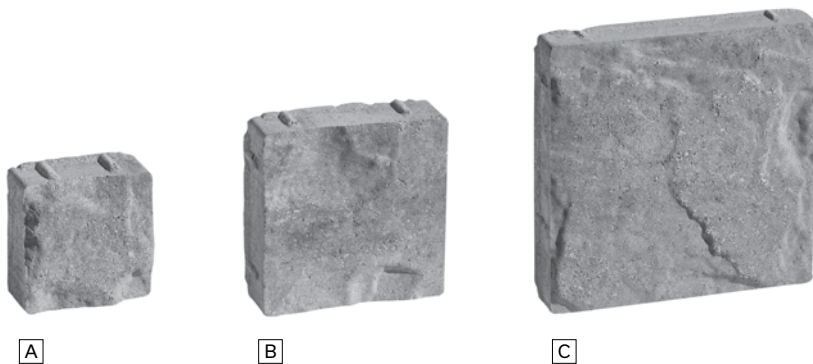

Laying Pattern:

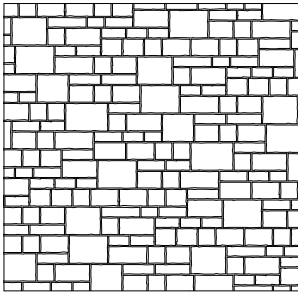

Linear

* Follow the polystyrene laying pattern

Typical Row:

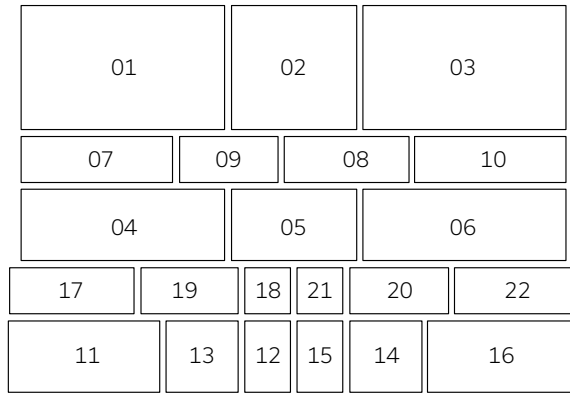

Components

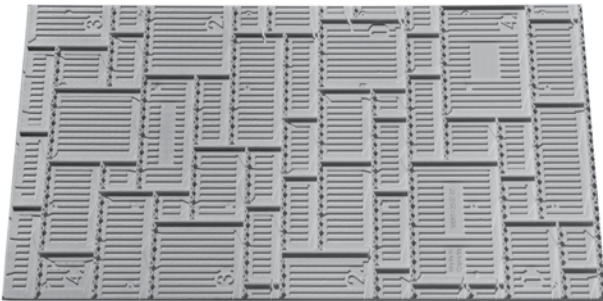

Polystyrene panel
50 x 1219 x 2438 mm - 2 x 48 x 96 in



Kit 90 - anchors, screws, weep



Starter Base
83 x 83 x 3048 mm - 3 1/2 x 3 1/2 x 120 in

Necessary installation material

Durham Stone				Product code
Sq.ft. of stone/pallet	1 cube = 12 rows	1 row = 12.42	Total : 149 ft ²	
Polystyrene panels	1 pack (7 panels) = 1 cube of stone		1 panel = 26 ft ²	34359039
Kit 90 - anchors/screws	1 box of anchors/screws 90 = 1 cube of stone			34359020
	1 bag 30 kg = 35 ft ²			
Mortar	1-1-6 mortar mix recommended			

Technical information

Product	Standard	Compressive Strength	Density	Dimension Tolerance
Durham Stone	CSA A165.94	25 MPa	A: Over 2000 kg/m ³	Thickness: ±2.0 mm Height: ±2.0 mm Length: ±3.0 mm

* See CCMC accreditation for more technical information



Suretouch Morency Stone



The main feature is its rough texture, giving it the true look of building stone that brings a touch of elegance to your home.

Weight per cube (kg)	1330
Rows per cube	15
Sq.ft. per row	10.67
Sq.ft. per cube	160.05

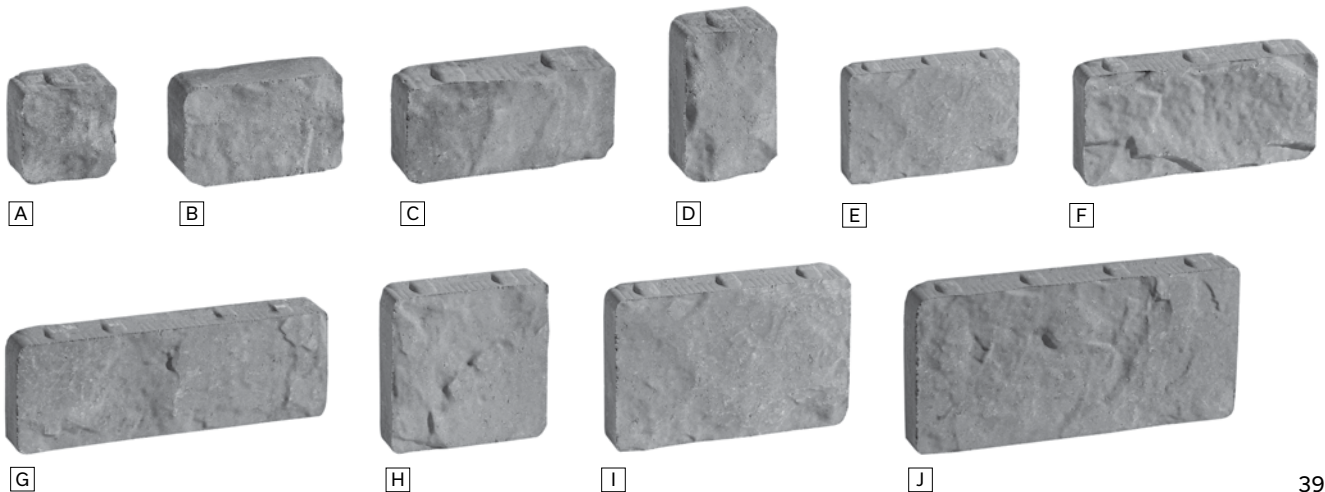

Laying Pattern:

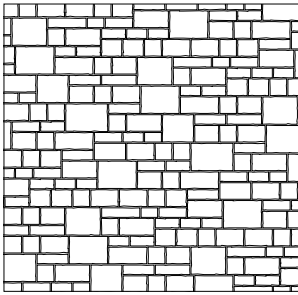

Linear

* Follow the polystyrene laying pattern

Typical Row:

33	14	15	16	31	32
30	27		07	08	28
29	24	06	25	26	
21	05	22		13	23
19	04	03	11	12	20
17	01	02	09	10	18

Components



Polystyrene panel
50 x 1219 x 2438 mm - 2 x 48 x 96 in



Kit 90 - anchors, screws,
weep



Starter Base
83 x 83 x 3048 mm - 3 1/2 x 3 1/2 x 120 in

Necessary installation material

Morency Stone				Product code
Sq.ft. of stone/pallet	1 cube = 15 rows	1 row = 10.66	Total : 160 ft ²	
Polystyrene panels	1 pack (6 panels) = 1 cube of stone		1 panel = 32 ft ²	34359013
Kit 90 - anchors/screws	1 box of anchors/screws 90 = 1 cube of stone			34359020
	1 bag 30 kg = 25 ft ²			
Mortar	1-1-6 mortar mix recommended			

Technical information

Product	Standard	Compressive Strength	Density	Dimension Tolerance
Morency Stone	CSA A165.94	25 MPa	A: Over 2000 kg/m ³	Thickness: ±2.0 mm Height: ±2.0 mm Length: ±3.0 mm

* See CCMC accreditation for more technical information



Suretouch Virtuo Stone

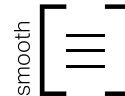

- Fine lines and smooth surfaces
- Available in various trendy and contemporary colours
- Fully finished corners

Weight per cube (kg)	1183
Rows per cube	12
Sq.ft. per row	9.32
Sq.ft. per cube	111.84
Lin. ft. per row	14
Lin. ft. per cube	168.05



A



B



C



D

Laying Pattern:

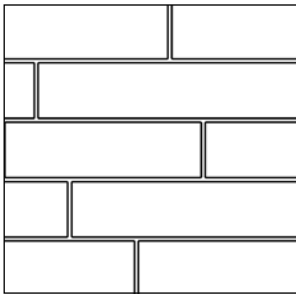

Linear

* Follow the polystyrene laying pattern

Typical Layout:



Components

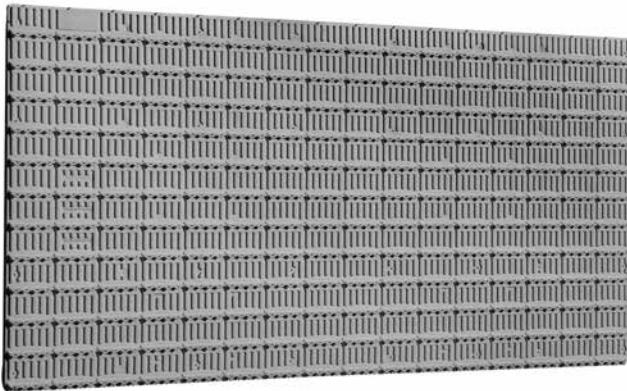

Polystyrene panel
50 x 1219 x 2438 mm - 2 x 48 x 96 in



Kit 90 - anchors, screws, weep



Starter Base
83 x 83 x 3048 mm - 3 1/2 x 3 1/2 x 120 in

Necessary installation material

Virtuo Stone			Product code
Sq.ft. of stone/pallet	1 cube = 12 rows	1 row = 9.32	Total : 111.84 ft ²
Polystyrene panels	1 pack (6 panels) = 1 cube of stone		1 panel = 32.5 ft ²
Kit 90 - anchors/screws	1 box of anchors/screws 90 = 1 cube of stone		34350052
	1 bag 30 kg = 45 ft ²		34359020
Mortar	1-1-6 mortar mix recommended		

Technical information

Product	Standard	Compressive Strength	Density	Dimension Tolerance
Virtuo Stone	CSA A165.94	25 MPa	A: Over 2000 kg/m ³	Thickness: ±2.0 mm Height: ±2.0 mm Length: ±3.0 mm

* See CCMC accreditation for more technical information

A unique experience for professionals

Discover our dedicated **Pro Zone**. Check out our tools and resources, take advantage of our specialized training courses, and more. Turn your ideas into reality with Permacon!

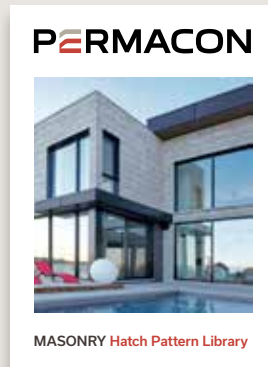
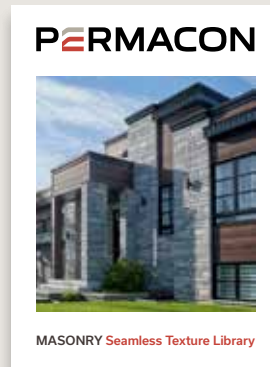

Visual Resources

Explore our online directories of masonry hatch patterns and textures, making it easy to create visually rich, detailed designs.



Lunch & Learn

We offer various seminars on our products featuring technical and design features, specification options, installation guidelines and our services to assist with successful project design.



The samples you need

Make sure you choose the right material for your project by ordering samples of our products for on-site evaluation.



State-of-the-art tools

Access Permacon seamless textures and hatch patterns for use in your design software.





50-Year Warranty

Masonry Products for Residential Use



Permacon's 50-year warranty applies to landscape and masonry products including Suretouch intended for residential use¹. This warranty statement affirms that products manufactured by Permacon meet the requirements of CSA (Canadian Standard Association) and ASTM (American Society for Testing and Materials) standards.

For details regarding commercial applications, please refer to our institutional, commercial and industrial warranty.

Permacon guarantees that, as of the date of delivery, its concrete products are free from manufacturing defects. Provided that the conditions set forth below are met, Permacon guarantees the structural integrity of the concrete in its landscaping and masonry products for a period of 50 years from the date of the product's purchase. The warranty applies to normal, non-abusive use of the product. To preserve the original appearance of your products, we recommend that you consult our **Landscape Maintenance Guide** available on our website.

IN ALL CASES DETAILED BELOW, THE WARRANTY IS LIMITED TO THE PRODUCTS' MARKET VALUE.

How do I make a claim?



permacon.ca/en/warranty/



Proof of purchase is required to proceed with a claim request. No claims will be accepted without proof of purchase.²

All claims must be reported within 15 days of the discovery of a product's defect. To validate a claim, a Permacon representative will arrive to inspect the defective products in order to confirm whether the claim is eligible. Therefore, it is essential to provide Permacon with the necessary access to inspect and take photos of the affected products.

This warranty is the only one that is presently offered. Because Permacon continually improves and modifies its products, it may alter and discontinue products at any time, and therefore may replace warranty-covered products with products of similar quality or offer monetary compensation if the products under warranty have been discontinued or are no longer on the market while the warranty is active.

In the event that a product is found to be non-compliant by Permacon or an authorized representative of the company, and in order to proceed with compensation, Permacon will take into account the number of months during which the

landscape or masonry products were in the possession of the owner or their contractor, up to the date of the claim, and will prorate the amount of the payment or replacement to be made accordingly.

For example, if the purchaser makes a warranty claim in the last month of the 10th year of the warranty (i.e., the 120th month), the manufacturer, at its sole discretion, shall either:

- Provide a replacement for the product in question if still available (only the defective product will be replaced);
- Return 480/600 of the price paid for the products to the owner. No labour, transportation, or other compensation will be covered by Permacon.

Transferability

The warranty is transferable. Proof of warranty registration will still be required in the event of a claim. The prorated period will be based on the 50-year warranty period remaining as an assignee, if the purchaser transfers the warranty to a subsequent owner, as described above.

¹ The following locations are defined as residential: family dwelling of five units or less, single family homes, garden suites, or townhouses.

² The following documents are considered valid proof of purchase: invoices directly from an authorized Permacon distributor, or invoice from a landscape contractor, general contractor, mason, or home builder.

Exclusions

A landscape or masonry product installed on an area of more than **100 square feet** confirms the acceptance of the product received on the job site and that no claim can be made to Permacon regarding the colour, size, or texture of the product.

This warranty excludes all products not supplied by Permacon, as well as any defects, failures, or damages that may result from the actions listed below:

- Contact with chemicals or cleaning products;
- Damage caused by pressure washers;
- Improper installation or other construction activities that do not comply with the installation standards established by ICPI, NCMA or IMQ, the National Building Code or the installation methods and tips recommended by Permacon. The installation guides provided by Permacon represent certain installation situations and are not exhaustive. It is therefore strongly recommended that you consult a qualified professional to ensure the proper installation of Permacon products on a specific job site;
- Defective design or construction resulting in sagging, shifting, or failure;
- Breakage due to shock, impact, or excessive load during handling, use, or transportation;
- Natural disaster or other uncontrollable event;
- Breakage and damage to products caused by soil movement or building movement as well as misuse of construction, compaction, or snow removal equipment. The warranty does not cover surface deterioration caused by the misuse of sodium chloride (NaCl) to de-ice pavers, slabs, or steps;
- The use of sodium chloride (NaCl) on the following products:
 - Step Valentia;
 - Valentia Block;
- Be.OnStone and Mirage products sold by Permacon.

Installation

When installing masonry products, all work must be cleaned to remove any residues and contaminants left on the stone or brick. Permacon accepts no responsibility for stains and colour changes caused by installation residue or the consequences of cleaning these residues.

Colour

The presence of natural ingredients used in the manufacturing process varies from one product to another. Therefore, the product received on the job site will not be completely identical to the products displayed in our commercial presentations (catalogs, samples, displays). Any difference in colour will not be covered by the guarantee.

Photos of our products in landscape and masonry brochures, as well as in displays such as masonry panels and landscape racks at our distributors, are not an exact representation of the products that will be delivered to the job site. Permacon offers a variety of products with different colours to reproduce the appearance of natural stone. It is therefore strongly recommended that you view several products directly from your authorized Permacon distributor to see all available colours.

It is the purchaser's responsibility to approve the products (and their colour) delivered to the job site prior to installation to confirm satisfaction. It is also recommended to mix products from different pallets received on the job site. Since variations in colour shades are a natural phenomenon, Permacon does not guarantee colour uniformity between different pallets on the same job site. Product installation constitutes acceptance.

Polymeric film

A whitish polymeric film can be found on the surface of Permacon's products. This is the result of an inadequate use of polymeric sand. Improper cleaning of slabs and pavers prior to the application of water on the product surface can cause this whitish polymeric film. This film does not affect the structural integrity of the product. Permacon cannot be held responsible for this phenomenon, which is not covered by the warranty.

Efflorescence

White traces on the surface of the product are caused by a natural phenomenon called efflorescence. More visible on darker products, efflorescence affects neither the intrinsic technical qualities nor the structural integrity of Permacon's products. The possible appearance of efflorescence cannot be the subject of any guarantee. In most cases, efflorescence disappears by itself over time.

Warranty

Masonry Products for Institutional, Commercial and Industrial Use

Permacon's warranty applies to landscaping and masonry products including Suretouch intended for institutional, commercial and industrial use¹. This warranty statement affirms that products manufactured by Permacon meet the requirements of the Canadian Standard Association (CSA) and American Society for Testing and Materials (ASTM).

Permacon guarantees that, as of the date of delivery, our concrete products are free from manufacturing defects. Provided the conditions set forth below are met, Permacon guarantees the structural integrity of the concrete in its landscaping products for a period of 5 years from the date of purchase of the product. The masonry products will be guaranteed for a period of 50 years. The warranty applies to normal, non-abusive use of the product.

IN ALL CASES DETAILED BELOW, THE WARRANTY IS LIMITED TO THE PRODUCTS' MARKET VALUE.

How do I make a claim?



permacon.ca/en/warranty/



Proof of purchase will be required to proceed with a claim request. No claims will be accepted without proof of purchase.²

All claims must be reported within 15 days of the discovery of a product's defect. To validate a claim, a Permacon representative will arrive to inspect the defective products in order to confirm whether the claim is admissible. Therefore, it is essential to provide Permacon with the necessary access to inspect and take photos of the products in question.

This warranty is the only one that is presently offered. Because Permacon continually improves and modifies its products, it may alter and discontinue products at any time, and therefore may replace warranty-covered products with products of similar quality or offer monetary compensation if the products under warranty have been discontinued or are no longer on the market while the warranty is active.

In the event that a product is found to be non-conforming by Permacon or an authorized representative of the company, and in order to proceed with compensation, Permacon will take into account the number of months during which the

landscaping or masonry products were in the possession of the owner or their contractor, up to the date of the claim, and will prorate the amount of the payment or replacement to be made accordingly.

For example: if the purchaser makes a warranty claim in the last month of the 2nd year of the warranty (i.e., the 24th month), the manufacturer, at its sole discretion, shall either :

- Provide a replacement for the product in question if still available (only the defective product will be replaced);
- Return 36/60 of the price paid for the products to the owner. No labor, transportation, or other compensation costs will be covered by Permacon.

Transferability

The warranty is transferable. Proof of warranty registration will still be required in the event of a claim. The prorated period will be based on the warranty period remaining as an assignee, if the purchaser transfers the limited warranty to a subsequent owner, as described above.

¹ The following areas are defined as institutional, commercial and industrial: public areas, businesses, family dwelling of six units or more, and all other non-residential areas

² The following documents are considered valid proof of purchase: an invoice from an authorized Permacon distributor or an invoice from a landscape contractor, general contractor, or mason

Exclusions

A landscaping or masonry product installed on an area of more than **100 square feet** confirms the acceptance of the product received on site and that no claim can be made to Permacon regarding the colour, size, or texture of the product.

This limited warranty excludes all products not supplied by Permacon, as well as any defects, failures, or damages that may result from the actions listed below:

- Contact with chemicals or cleaning products;
- Damage caused by pressure washers;
- Improper installation or other construction activities that do not comply with the installation standards established by ICPI, NCMA or IMQ, the National Building Code or the installation methods and tips recommended by Permacon. The installation guides provided by Permacon represent certain installation situations and are not exhaustive. It is therefore strongly recommended that you consult a qualified professional to ensure the proper installation of Permacon products on a specific job site;
- Defective design or construction resulting in sagging, shifting, or failure;
- Breakage due to shock, impact, or excessive load during handling, use, or transportation;
- Natural disaster or other uncontrollable event;
- Breakage and damage to products caused by soil movement or building movement as well as misuse of construction, compaction, or snow removal equipment. The warranty does not cover surface deterioration caused by the misuse of sodium chloride (NaCl) to de-ice pavers, slabs, or steps;
- The use of sodium chloride (NaCl) on the following products:
 - Step Valentia;
 - Valentia Block;
- Be.OnStone and Mirage products sold by Permacon.

Installation

When installing masonry products, it is vital that the work be cleaned to remove residue and contaminants left on the stone or brick. Permacon accepts no responsibility for stains and colour changes caused by installation residue or the consequences of cleaning said residue.

Colour

The presence of natural ingredients used in the manufacturing process varies from one product to another. Therefore, the product received on the job site will not be completely identical to the products presented in our commercial presentations (catalogs, samples, displays). Any difference in colour cannot be attributed to the guarantee.

Photos of our products in landscape and masonry brochures, as well as in displays such as masonry panels and landscape racks at our distributors, are not an exact representation of the products that will be delivered to the job site. Permacon offers a variety of products with different colours to reproduce the appearance of natural stone. It is therefore strongly recommended that you view several products directly from your authorized Permacon distributor to see all available colours.

It is the purchaser's responsibility to approve the products delivered to the job site prior to installation and to ensure that the colour is satisfactory. It is also recommended to mix products from different pallets received on site. Since variations in colour shades are a natural phenomenon, Permacon does not guarantee colour uniformity between different pallets on the same job site. Product installation constitutes acceptance.

Polymeric film

A whitish polymeric film can be found on the surface of our products. This is the result of an inadequate use of polymeric sand. Improper cleaning of slabs and pavers prior to the application of water on the products' surface can cause this whitish polymeric film. This film does not affect the structural integrity of the product. Permacon cannot be held responsible for this phenomenon, which is not covered by the warranty.

Efflorescence

White traces on the surface of the product are caused by a natural phenomenon called efflorescence. More visible on darker products, efflorescence affects neither the intrinsic technical qualities nor the structural integrity of our products. The possible appearance of efflorescence cannot be the subject of any guarantee on our part. In most cases, efflorescence disappears by itself over time.



Since 1952, all Permacon products have been made with passion and pride in Canada.

permacon.ca

1 888 PERMACON



PERMACON
A CRH COMPANY