

Celtik® Plus 90 Wall

DESCRIPTION



With a maximum height of 42 inches, the Celtik wall is reminiscent of old stone structures typical of the Irish and Scottish countryside. Its rich texture and variety of units gives you a choice between the uneven look of cut stone and the more linear look of a brick.

ADVANTAGES:

Patented anchor pin system located at the back of the block makes it possible to:

- > build sloped or vertical walls with minimum cutting, chiselling or using a guillotine
- > easily create a radius or curves

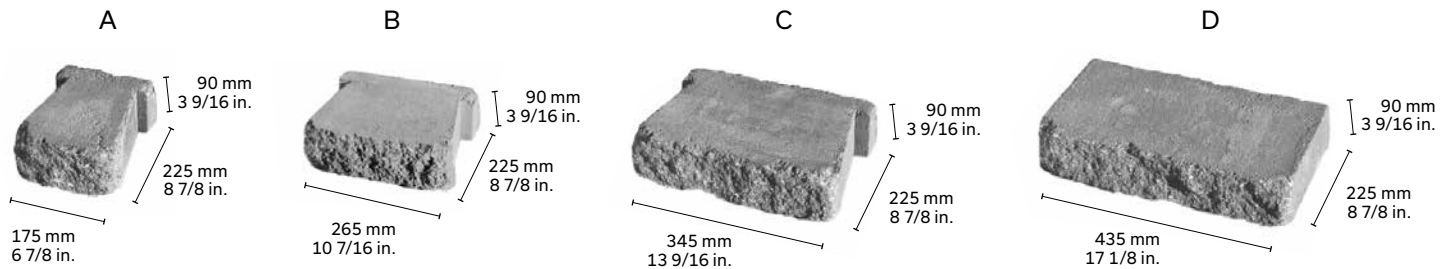

LAYING PATTERN

LINEAR PATTERN

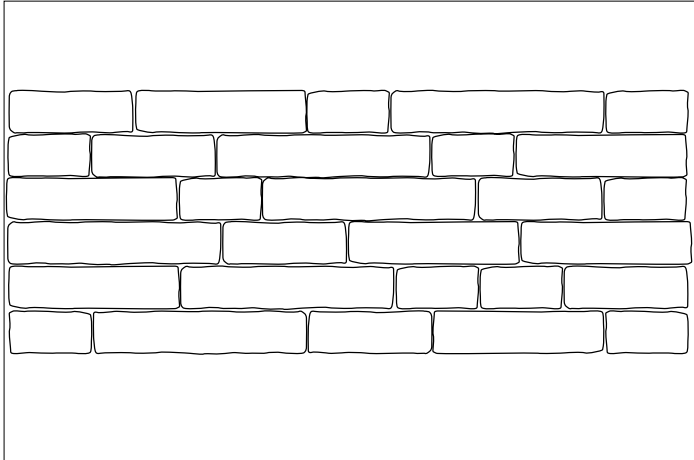

ANCHOR PIN SYSTEM

The Celtik wall anchor pin system is designed to facilitate the construction of walls with a maximum height of 42 in - 1.1 m. The special pin system is designed to stabilize the overall structure and guide the installation of units. The dual-position system allows for the construction of vertical or 9° sloped walls. Units are delivered with two different anchor pins: a regular pin with blades (C1) and a second pin without blades (C2), designed for the construction of corners.

For a 9° of slope, the setback per row of 90 mm is 14 mm - 9/16 in.

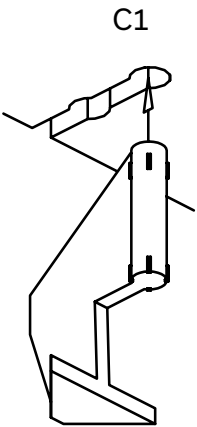

Position for building a wall on a 9° slope.
Maximum height of 1.05 m - 42 in.

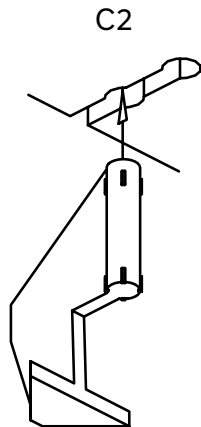

Position for building a vertical wall.
Maximum height of 0.65 m - 26 in.

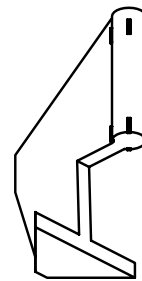

C1 - Base model

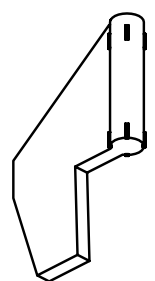

C2 - Model without blades

LAYING IDEAS

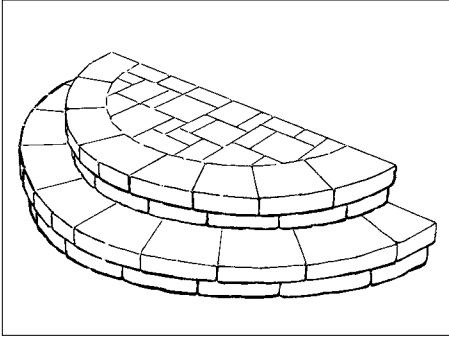

CURVED STEPS using 90 mm

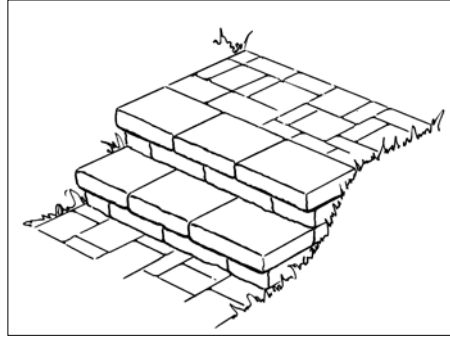

STRAIGHT STEPS

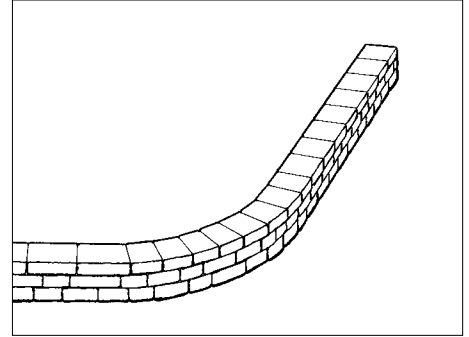

CURVED AND STRAIGHT WALL

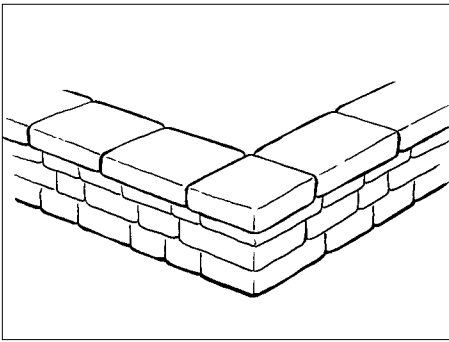

CORNER WITH STRAIGHT CUT

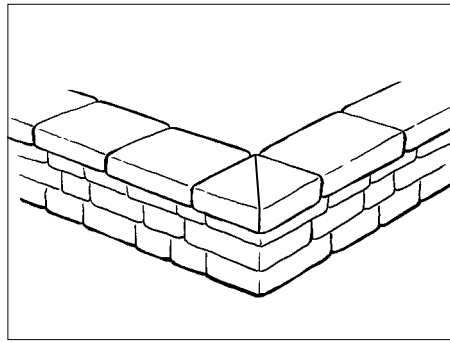

CORNER WITH 45° ANGLE CUT

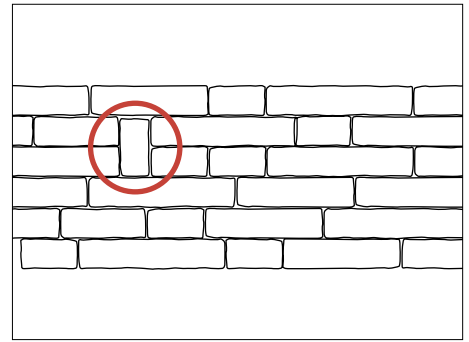

90 mm UNIT WITH JUMPER (vertical element)

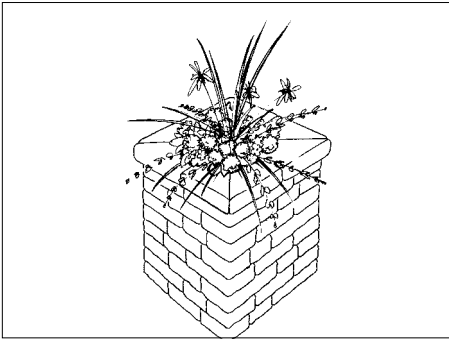

PILLAR with flowers

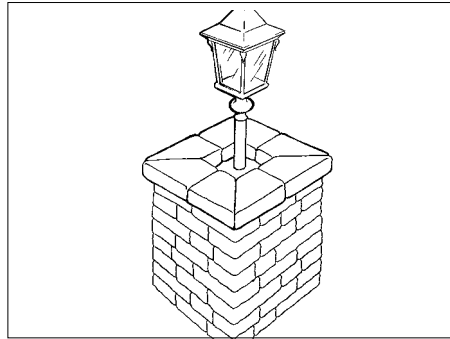

LIGHT PILLAR

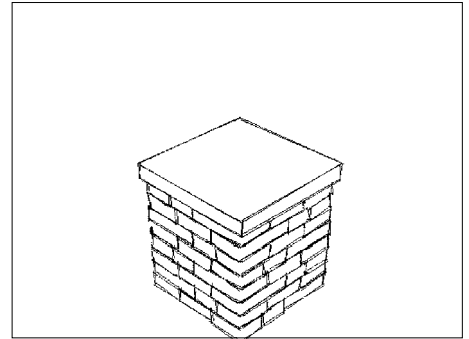

CELTIK 90 PILLAR

CELTIK PLUS WALL CONSTRUCTION

STEP 1

INSTALLATION OF THE FIRST ROW

Lay the units of the same thickness on the compacted foundation. It is important to carefully align the first row of units horizontally to ensure that the wall will be levelled. At this stage, no pins are used.

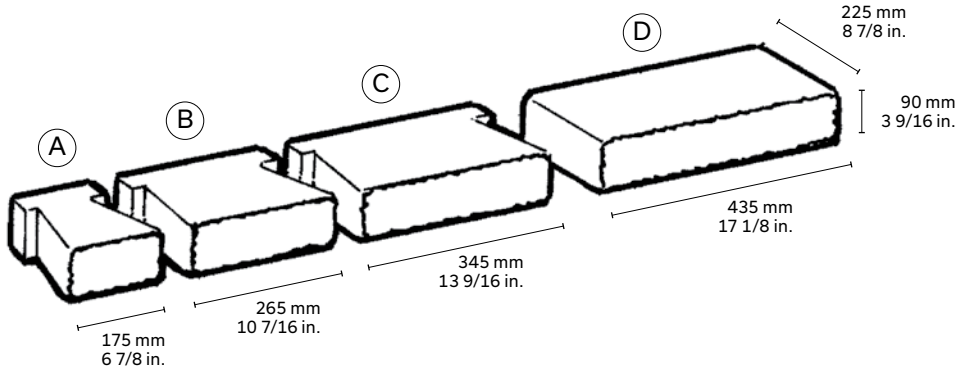

STEP 2

INSTALLATION OF THE FOLLOWING ROWS

Carefully lay the units of the following rows, remembering however, to insert a pin in each unit before installation. First insert pins in units to be installed. Use appropriate grooves depending on whether the wall is vertical (maximum 26 in.) or 9' sloped (maximum 42 in.). Lay each row by overlapping joints of the last row installed.

Supplied radiuses may be used vertically to give a natural and original look to the layout. Two of the radiuses measures two rows high. Use unit A (6 7/8 in.) to match two 90 mm rows.

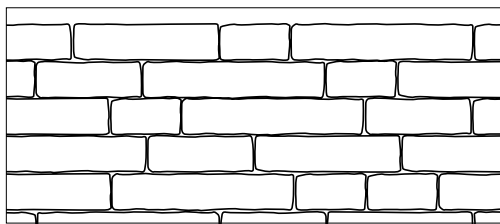

90 mm UNITS

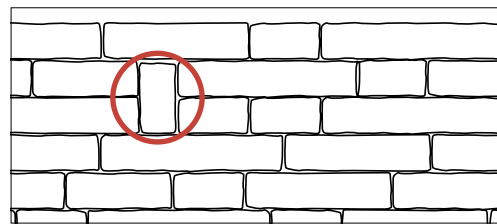

90 mm UNITS WITH JUMPERS (vertical elements)

STEP 3

BACK FILLING

Every two rows, fill the space behind units only with 3/4 in. - 20 mm clean stone. Repeat steps 2 and 3 up to the desired height.

NOTE: The dimensions of the Imperial system are approximate

CELTIK PLUS WALL CAPPING

OPTION A - REGULAR UNITS

Walls can also be capped using Celtik standard units, in one of two styles:

- > flush
- > overhanging

In either case, the units must be properly secured with adhesive to ensure wall stability. Save straight unit (D) for capping the straight portions of the wall. Use bevelled units for the curved portions; less cutting will be required.

ADVANTAGE

A Celtik retaining wall with standard units as capping units is economical, easy to install and versatile, offering a number of possibilities.

NOTE: Several small units will give a shorter bend radius, while larger units will give a larger radius.

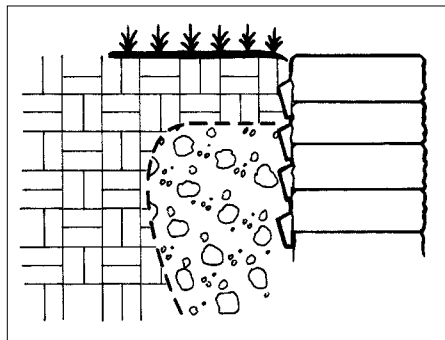
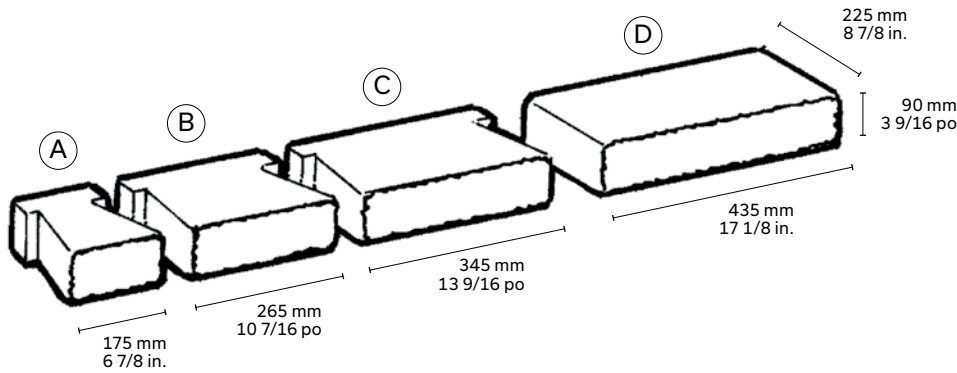

FLUSH CAPPING

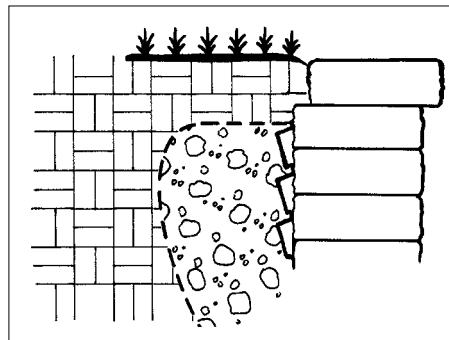

OVERHANGING CAPPING

TO CREATE CURVES IN A CELTIK WALL: the minimum radius is 0.9 m - 3 ft.

CONVEX CURVE: strike the extremities of the unit at the back

CONCAVE CURVE: unit will have to be cut

OPTION B - CELTIK PLUS CAPPING UNITS

Use Celtik capping units to complete your wall. It is important to anchor the Celtik caps with Techniseal concrete adhesive.

NOTE: The dimensions of the Imperial system are approximate

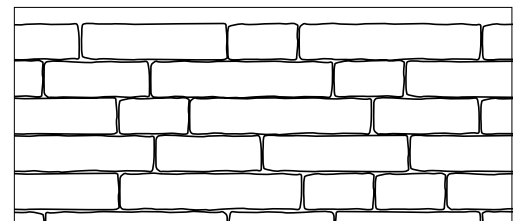

90 mm UNITS

CELTIK PLUS PILLAR USING ALL CELTIK PLUS UNITS

CELTIK PILLAR: 734 x 734 mm - 29 x 29 in.

To build a pillar minimizing joint alignment and better stability, be sure to follow the laying order for each step and row, as illustrated. Measure the site for the pillar(s). Each pillar measures of 734 x 734 mm - 29 x 29 in. Always secure each row with adhesive to ensure stability.

FOR THE CORNERS, CUT C AND D UNIT AS ILLUSTRATED:

- > Trim the C unit in the middle
- > Trim the D unit along one of the two grooves (left or right)

1 INSTALLATION OF THE FIRST ROW

Lay the first four units as illustrated (A, B, C and D) followed by the next four.

2 INSTALLATION OF THE SECOND, THIRD AND FOURTH ROWS

For each row, proceed as illustrated. Starting from the fifth row, repeat instruction steps 1 and 2, followed by the next ones until the desired height is reached (see illustration).

3 CAPPING A PILLAR

Use Celtik Plus straight capping units or a natural stone capping unit

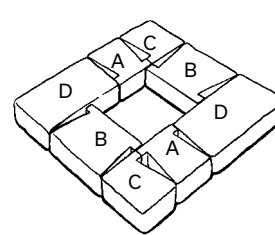
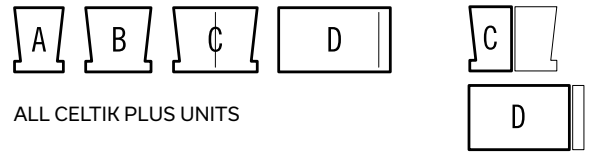

STEP 1 : rows 1 and 5

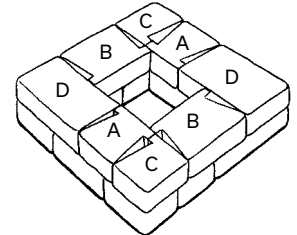

STEP 2 : rows 2 and 6

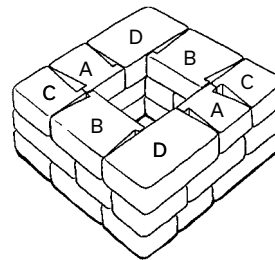

STEP 3 : rows 3 and 7

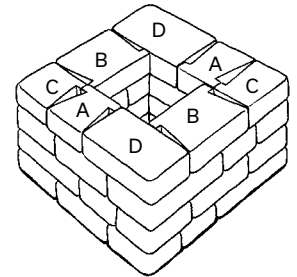

STEP 4 : rows 4 and 8

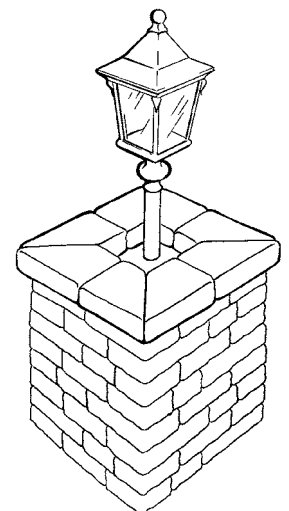
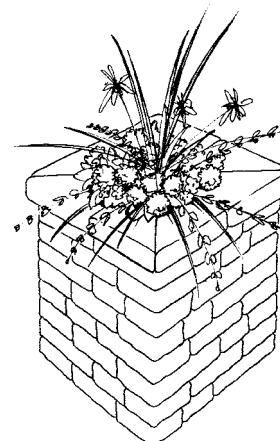
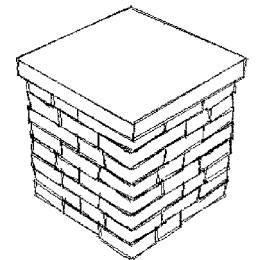
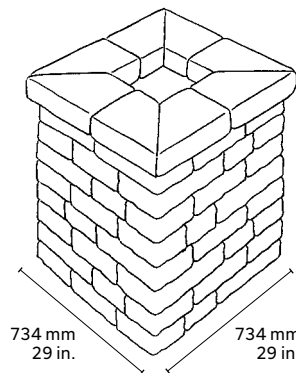

WARNING

If a lit pillar is desired, make sure all electrical wiring is completed before the units are laid.

If flowers are to be planted above the pillar, install a geotextile membrane inside the pillar before filling with garden soil.

CELTIK PLUS STRAIGHT CAPPING UNIT

The Celtik Plus straight capping unit can be used for all applications.

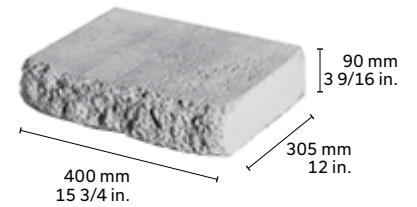

LAYING IDEA

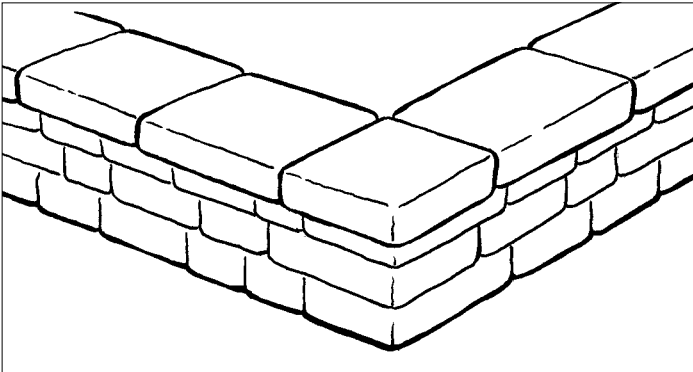

HOW TO ORDER

Celtik straight capping units are purchased individually. Each unit is 400 mm - 15 3/4 in. length.

- > Calculate the length in linear feet that you require for capping your Celtik wall
- > Divide the number of linear feet by 1.333 (the result will give you the number of units you need to cap your wall)
- > Order the required number of units

CAPPING A CORNER

PREPARE A CELTIK PLUS STRAIGHT CAPPING UNIT AS FOLLOWS:

- 1** Using a cold chisel or a guillotine, cut 100 mm - 4 in. from one of the ends of the capping unit
- 2** Flip the unit over and cut off the retaining lip
- 3** Hit the newly cut face with a sledge hammer to achieve the same finish as for the other sides
- 4** Install this corner cap first before proceeding with the installation of the other capping units
- 5** Always spread a layer of concrete adhesive along the top row of Celtik wall before laing the capping units

