

# Tandem<sup>®</sup> Next System

## SYSTEM ELEMENTS

### TANDEM NEXT STRUCTURAL UNIT 180 mm

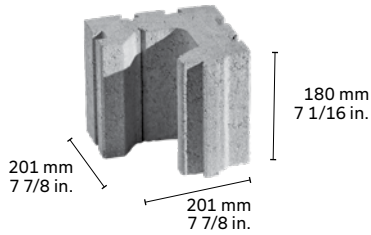

### STARTER UNIT

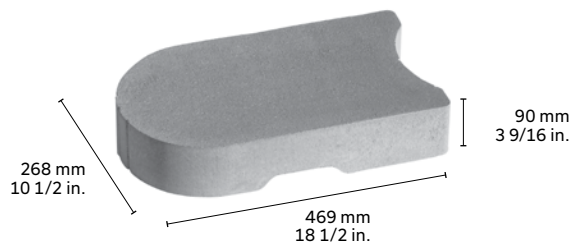

### TANDEM NEXT UNIVERSAL CONNECTOR



### MELVILLE PLUS 60 CAPPING UNIT

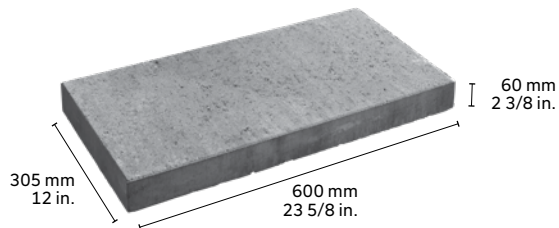

### MELVILLE PLUS 90 CAPPING UNIT

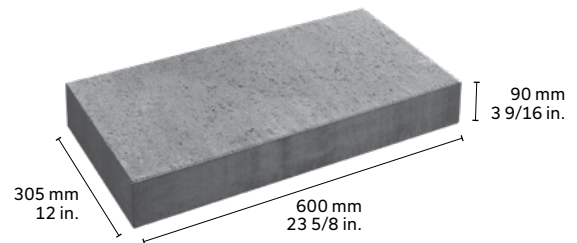

### MELVILLE PLUS STEP UNIT (FOR DOUBLE-SIDED WALL CAPPING)

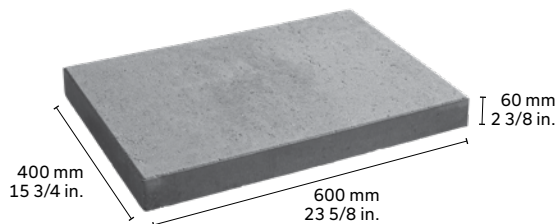

SYSTEM ELEMENTS (CONT'D)

LAFITT TANDEM VENEER UNITS 180 mm

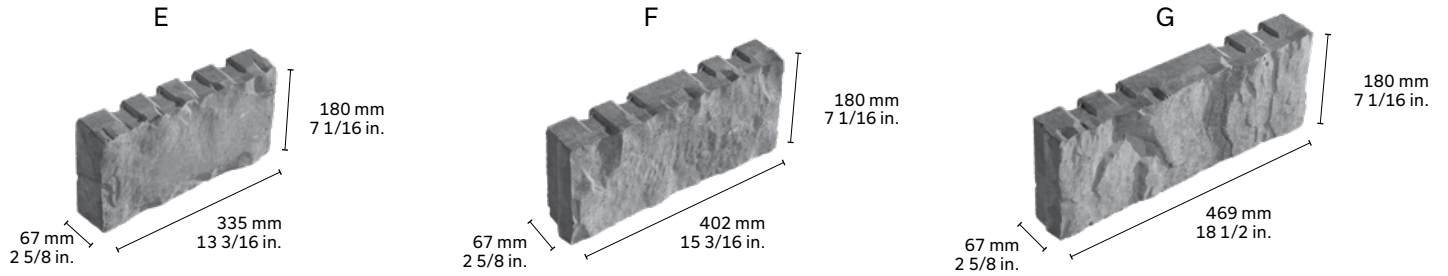

MELVILLE TANDEM VENEER UNITS 180 mm

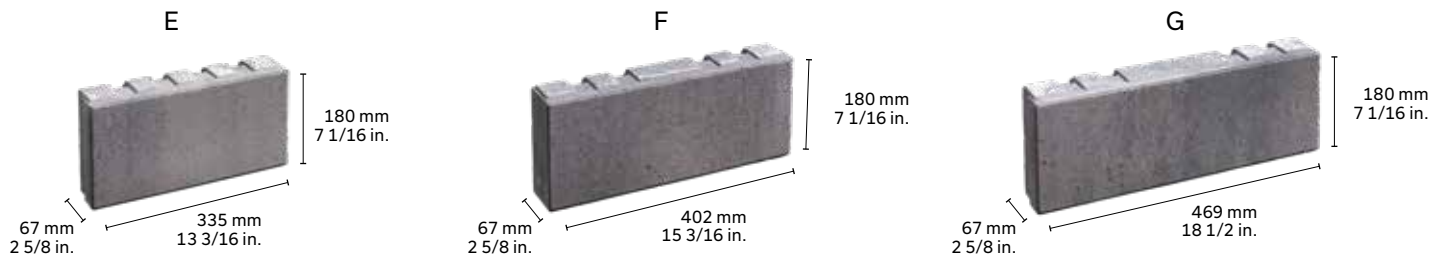

DESCRIPTION

The new Tandem Next 180 mm wall system allows the creation of retaining walls, double-sided walls, columns and stairs.

It applies the principle of interlocking a veneer unit into a structural unit with a dovetail joint (tenon and mortise or interlocking male/female system). Each structural unit has a vertical tenon (male side) and each veneer unit has at least two mortises (female side). The veneer units are joined to the structural units by simply sliding their tenon into the mortises to form the Tandem Next units.

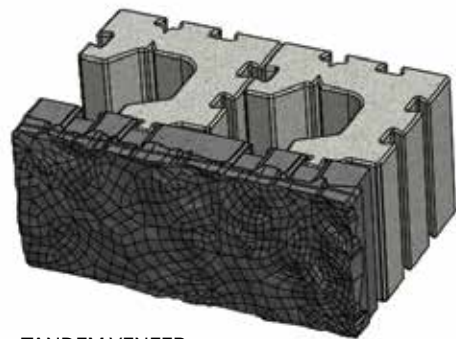

TANDEM VENEER  
(LAFITT, MELVILLE)

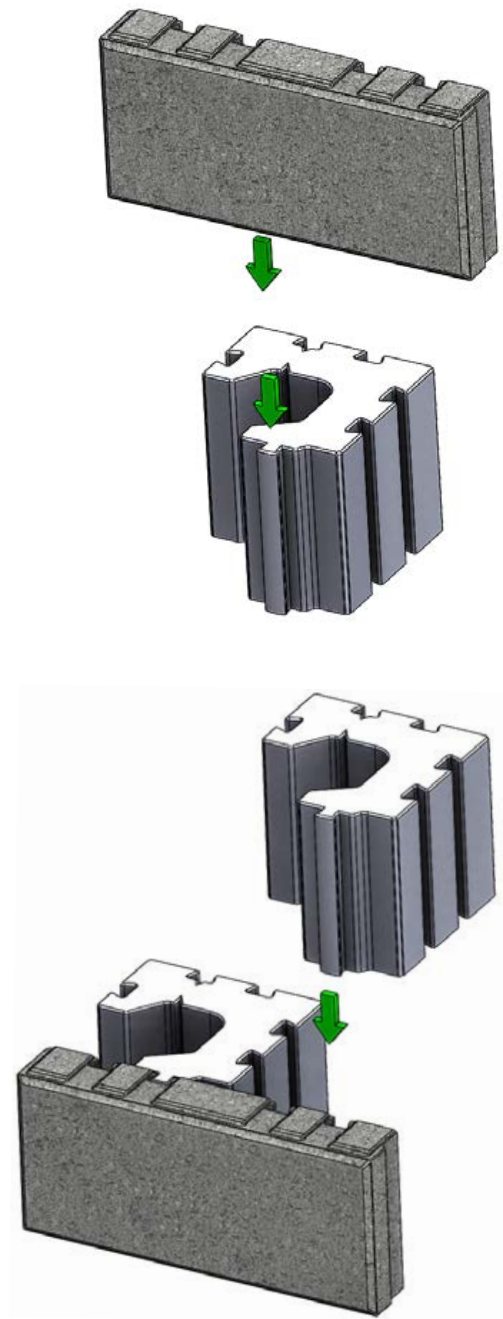

**ASSEMBLY**

Assembly of Tandem Next elements always requires the use of two structural units for one veneer unit, Melville and Lafitt Tandem. The structural units obviously must be positioned so that the tenons are always located behind a veneer unit.

**MURET TANDEM NEXT AVEC VENEERS TANDEM SYSTEM (LAFITT, MELVILLE)**

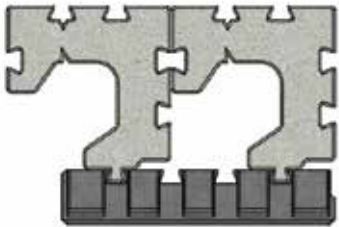

VENEER E

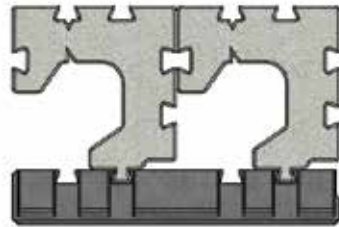

VENEER F

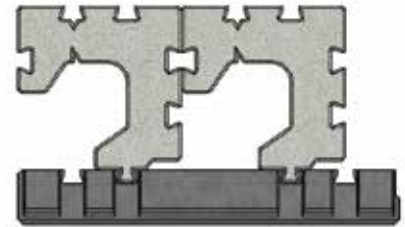

VENEER G

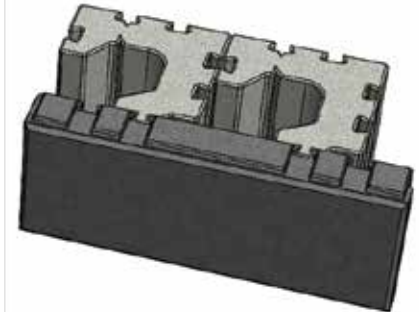
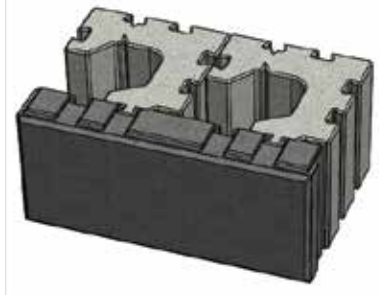
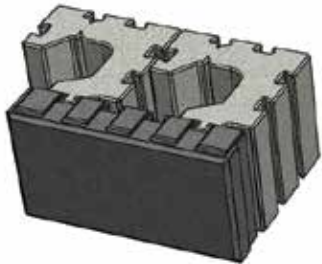

The structural units are reversible and the back can be oriented to the left or right depending on the veneer format used. It is recommended to place the structural units in the mortises farthest from a veneer whenever possible.



**SETBACK WALL**

The Tandem Next wall system allows construction of vertical or sloped walls using the universal connector specially designed for this purpose. This connector is inserted in one of the two grooves located on the back of the structural units. The connectors are slid from the top of the grooves until they overlap the structure unit located below by a few centimetres. In general, one universal anchor is required for each structural unit.

To build a sloped wall, the connector must be placed as shown in the drawing. Simply push the Tandem Next unit forward until the connector locks it. This will form a setback of about 9 mm relative to the lower unit.

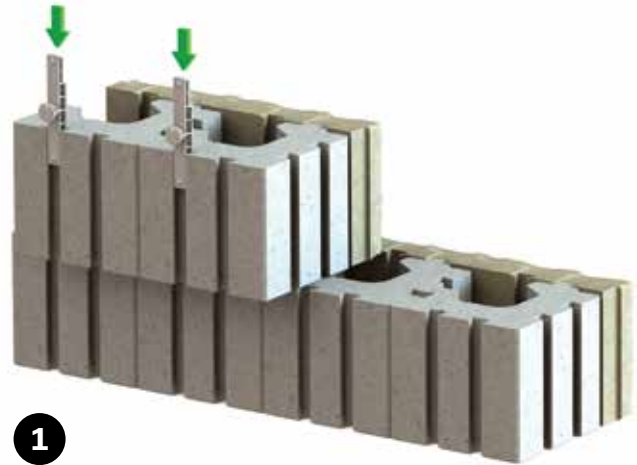

**1**

Slide the universal connector as follows (one connector per unit)

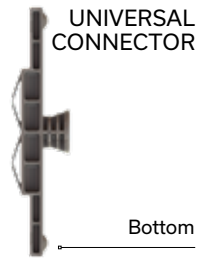

**2**

Exceed the lower part of the connector with the unit underneath

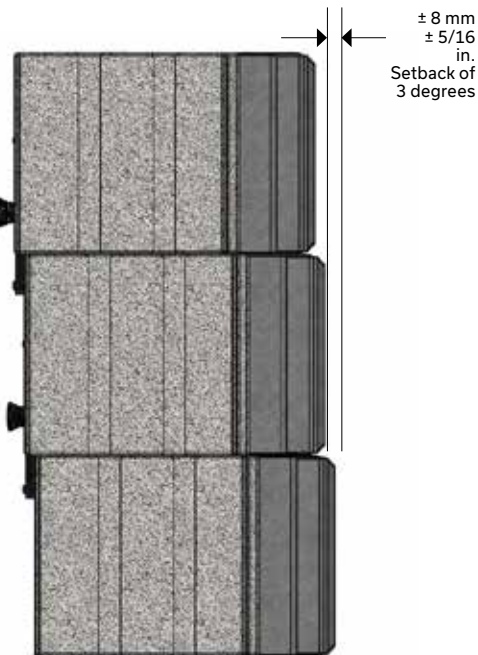

CROSS-SECTIONAL VIEW

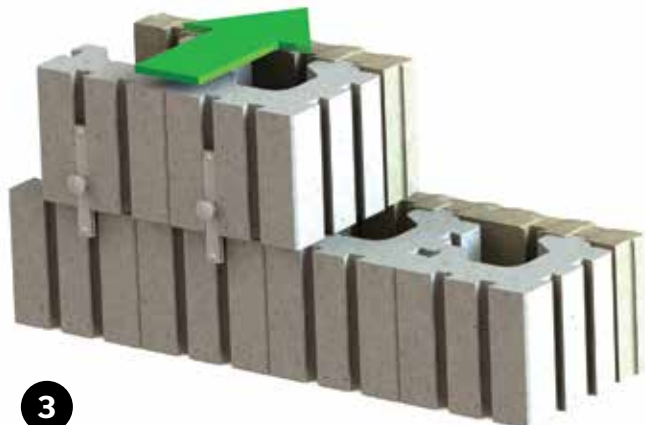

**3**

Push the unit forward until it locks

**VERTICAL WALL**

A vertical wall applies the same principle as a sloped wall, with the difference that the universal connector is simply turned 180 degrees (see the drawing). After insertion in a groove as far as the overlap with the unit underneath, the connector slopes slightly relative to the vertical. The Tandem Next unit then is pushed forward until it locks, to create a vertical wall.

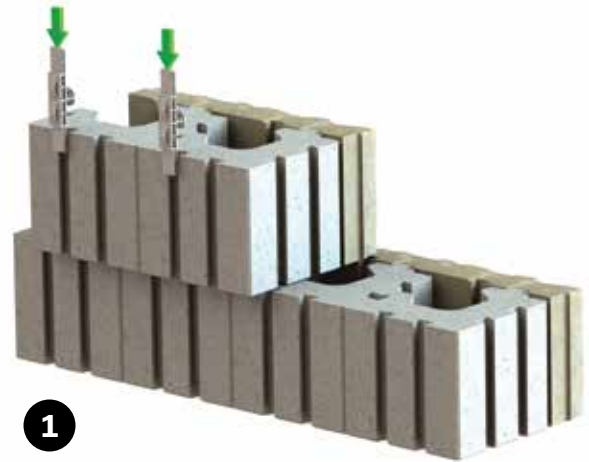
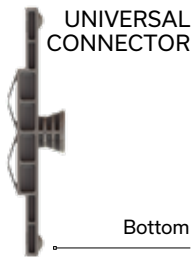

**1**  
Slide the universal connector as follows (one connector per unit)



**2**  
Exceed the lower part of the connector with the unit underneath

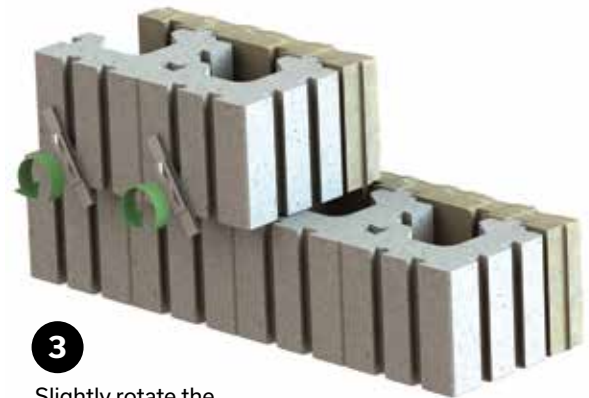

**3**  
Slightly rotate the universal connector

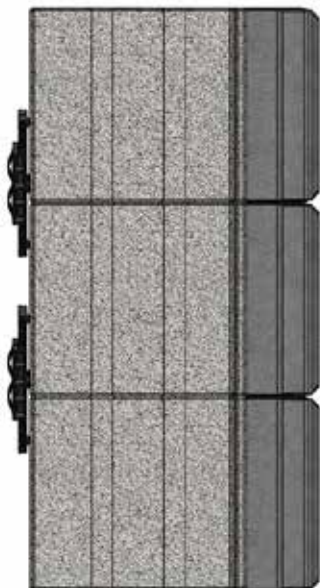

CROSS-SECTIONAL VIEW



**4**  
Push the unit forward until it locks

**REINFORCING WALLS**

**WALL MORE RESISTANT TO LOADS**

The maximum above-ground height of a Tandem Next retaining wall is 900 mm - 36 in. for a sloped wall and 560 mm - 22 in. for a vertical wall. A portion of the wall at least 150 mm - 6 in. high must be buried in the ground to ensure its stability.

The flexibility of the Tandem Next system allows interconnection of structural units by using Tandem Next universal connectors. This has the advantage of being able to build stronger walls by adding units in the back.

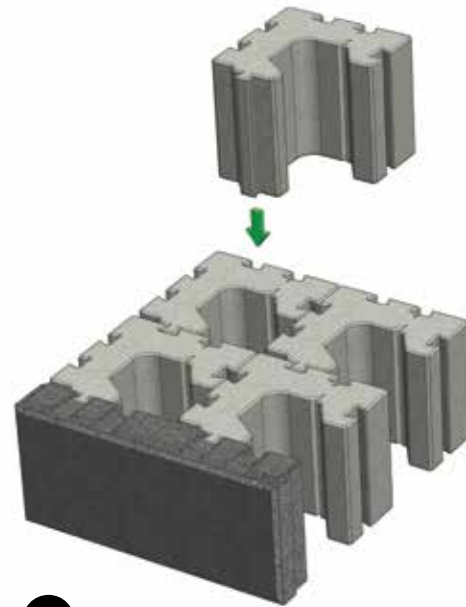

**1**

Install an additional structural unit by sliding the vertical tenon (male side) in the mortise (female side)

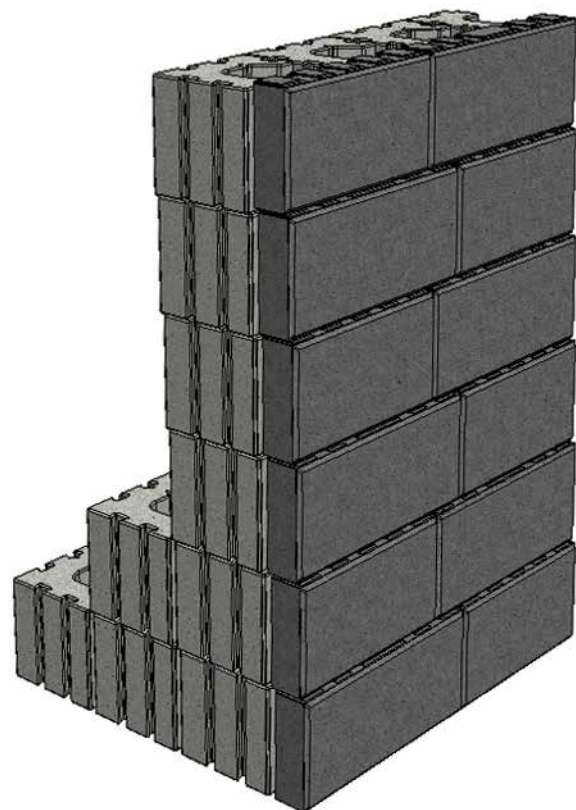
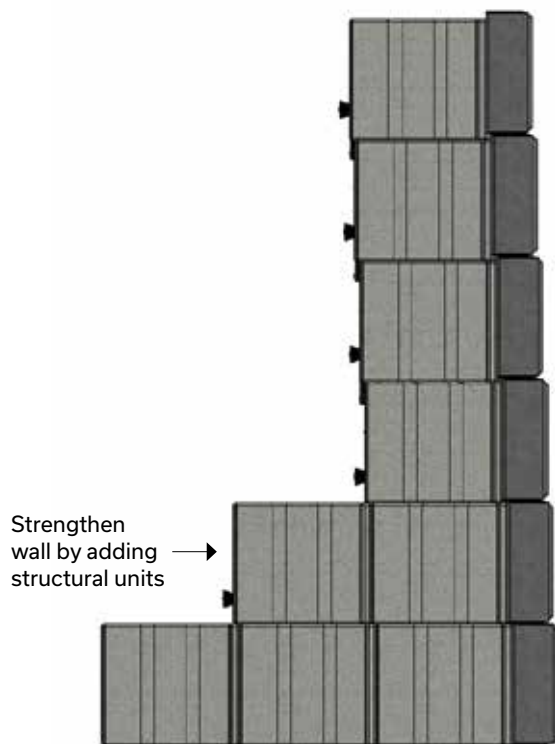

REINFORCING WALLS (CONT'D)

SLOPED TANDEM NEXT WALL

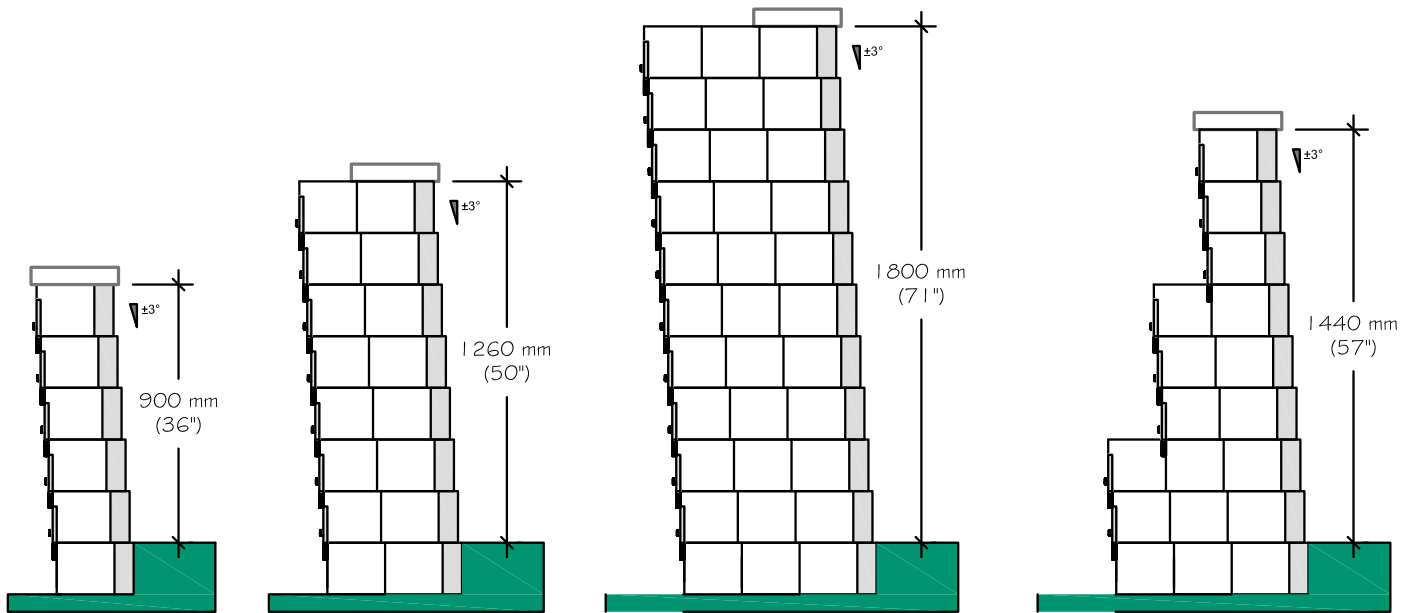

VERTICAL TANDEM NEXT WALL

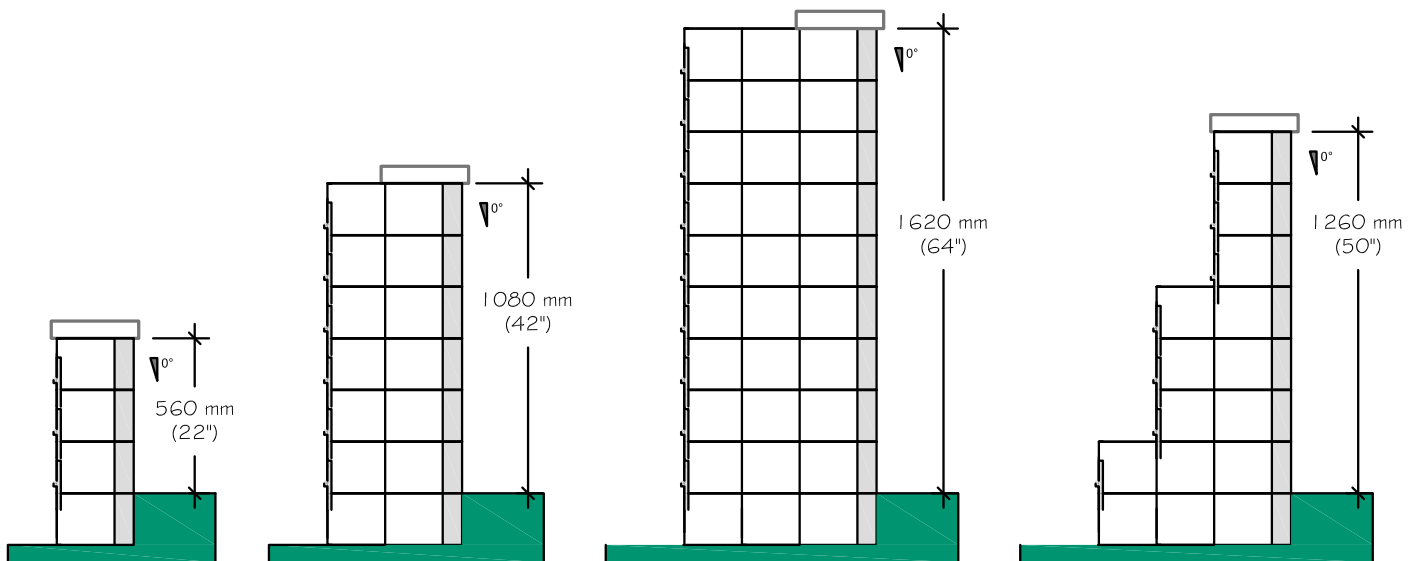

**CROSS-SECTION - TANDEM NEXT RETAINING WALL WITH INCLINATION**

Here we present the general typical construction cross-section of a Tandem Next wall. The width of a Tandem Next retaining wall is 268 mm - 10 1/2 in.

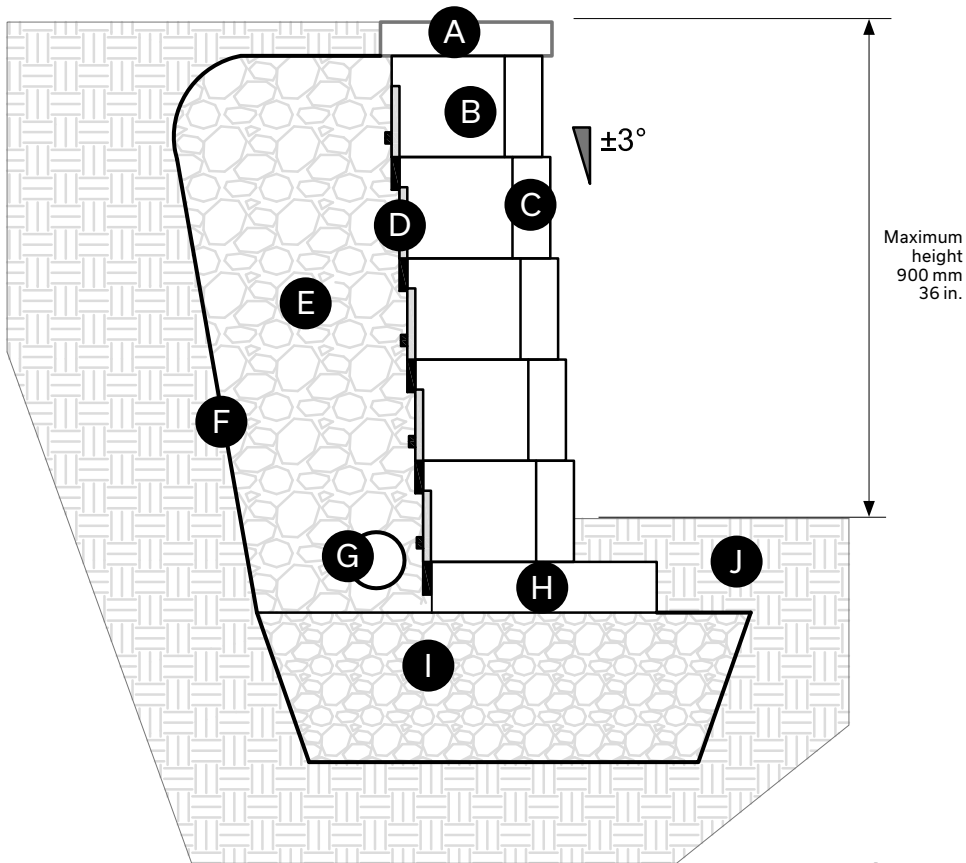

- A** Melville Plus capping unit (or other)  
60 x 305 x 600 mm - 2 3/8 x 12 x 23 5/8 in.
- B** Tandem Next wal structural unit  
180 x 201 x 201 mm - with 20 mm - 3/4 in.  
clear crushed stone
- C** 180 mm veneer unit (Tandem System)
- D** Tandem Next universal connector
- E** 20 mm - 3/4po clear stone 300 mm  
minimum
- F** Geotextile membrane
- G** Perforated drain 100 mm - 4 in. Ø  
connected to services
- H** Starter unit 90 x 268 x 469 mm -  
3 1/2 x 10 1/2 x 18 1/2 in.
- I** 0 to 20 mm - 0 to 3/4 in. compacted granular  
foundation 300 mm - 12 in. minimum
- J** Minimum buried depth 150 mm - 6 in.

LAYING PATTERN

LINEAR PATTERN  
100% Tandem 180

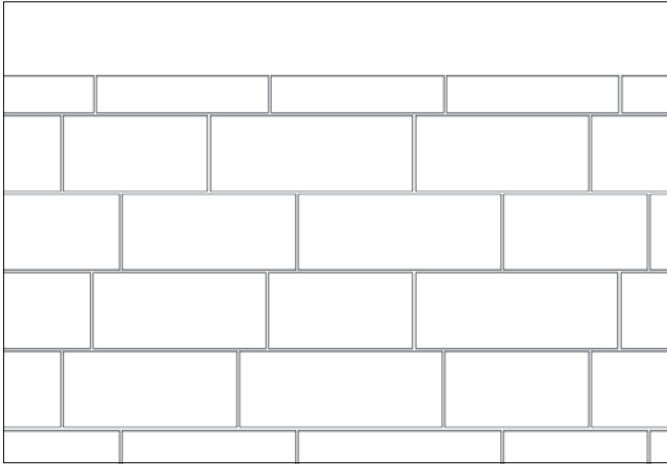

**CONSTRUCTION OF A RETAINING WALL**

**STRAIGHT WALL**

The construction of a Tandem Next wall begins with the placement of the starter units installed side by side (the longest side).

Install a first row of structural units at random on the starter units, using all the formats in equal proportions and following the indications for the typical cross-section. Then insert the veneer units in the structural units as described previously, and provide for the placement of the universal connectors depending on the chosen slope of the wall. The next rows are installed in the same way, avoiding alignment of the vertical joints of one row to another.

Clean stone must be installed behind the structural units. It is also recommended to install clean stone **in the empty spaces** of the structural units.

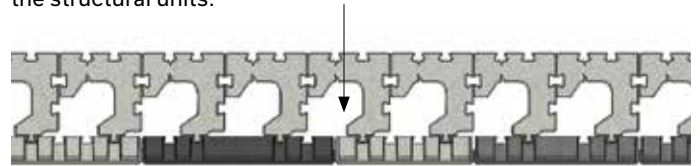

Melville and Lafitt Tandem

**CURVED WALL**

The construction of a Tandem Next curved wall begins with the placement of the starter units installed side by side (the longest side), bevelling the units to form the required curve.

Building a concave or convex curved walls is possible with the Tandem Next system. The use of smaller veneer units allows reduction of the bending radius. The back part of the structural units sometimes must be cut as illustrated to create the bevelled elements necessary for the construction of curved walls. The minimum bending radius of a Tandem Next wall is 2.4 m - 8 ft.

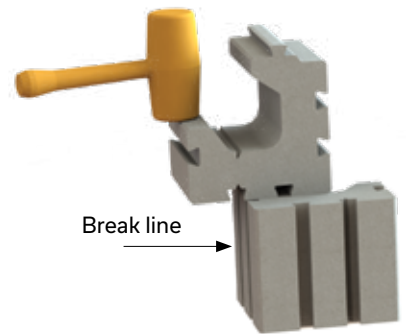
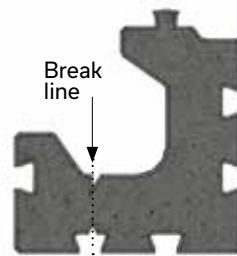

To close a concave curve, break the end of the unit with a hammer

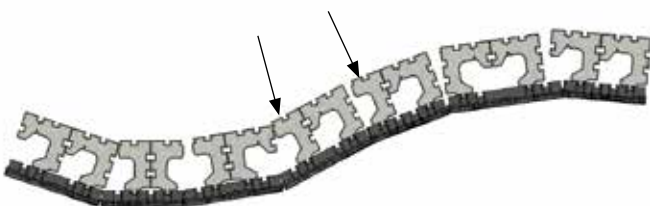



**CONSTRUCTION OF A RETAINING WALL (CONT'D)**

**BUILDING A 90° OUTER CORNER**

It is recommended to always begin a wall with a corner. A 90° outer corner is produced by using the veneers specially designed for this purpose, depending on the chosen type of veneer. The veneer units all contain integrated corners, but in different proportions depending on the chosen type of veneer.

A Lafitt Tandem 180 veneer cube contains 8 units with one 90° corner side per row. All the Melville Tandem 180 veneer units contain one corner side.

Stacking position on pallets (with a textured end)

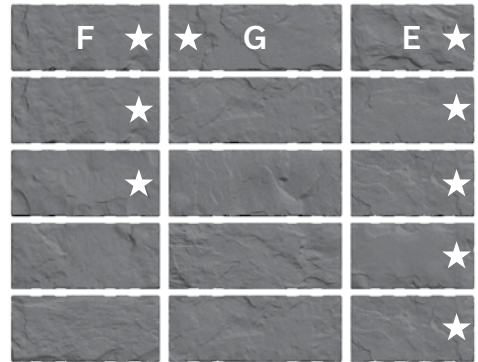

LAFITT TANDEM - 180 MM UNITS

**90° CORNER WALL PRINCIPLE**

The veneer units are reversible to form left or right corners. For each row, the veneer that forms the corner is affixed to the structural unit using a Tandem Next universal anchor. The position of the veneer is alternated 90° from one row to the next. We recommend gluing the elements used to make the corner of each row, using concrete adhesive. Spread the adhesive on the veneer units or the structural units or both. Only one universal anchor per row is required to form a corner. Long veneers must be affixed to the structural unit following the corner (tenons and mortise).

It is possible to add other structural units in the corners of a wall to strengthen it, if required.

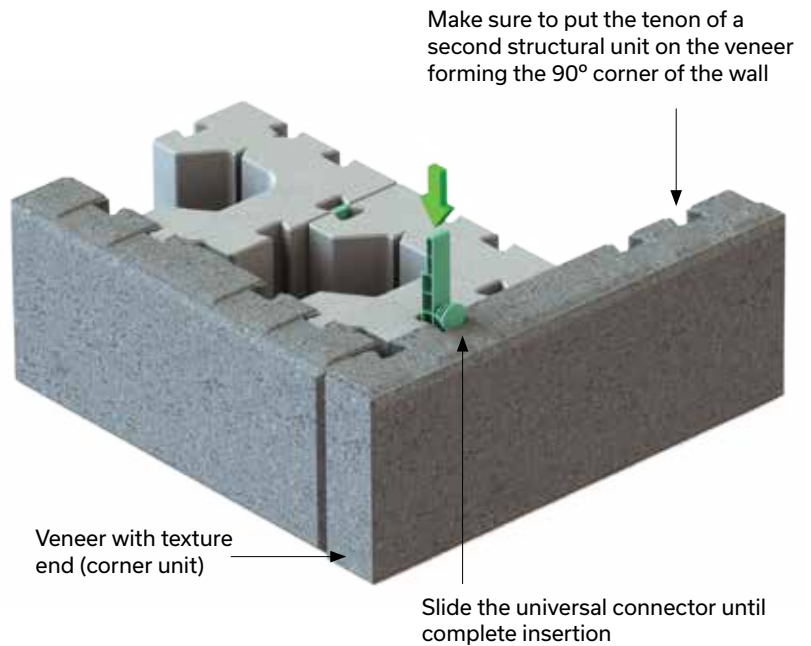

**CONSTRUCTION OF A RETAINING WALL (CONT'D)**

**BUILDING AN OUTER 90° CORNER WITH TANDEM VENEER (MELVILLE, LAFITT)**

Always use veneers with texture end (corner unit) to build a corner

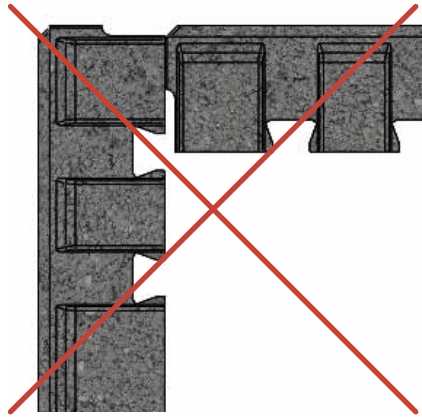
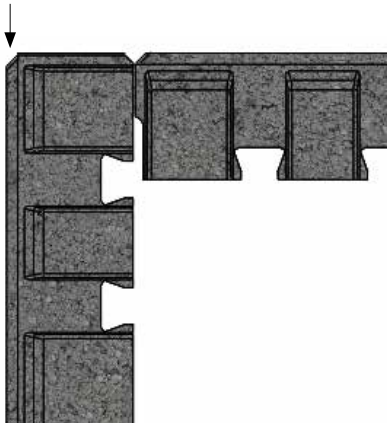

Make sure to put the tenon of a second structural unit on the veneer forming the corner of the wall

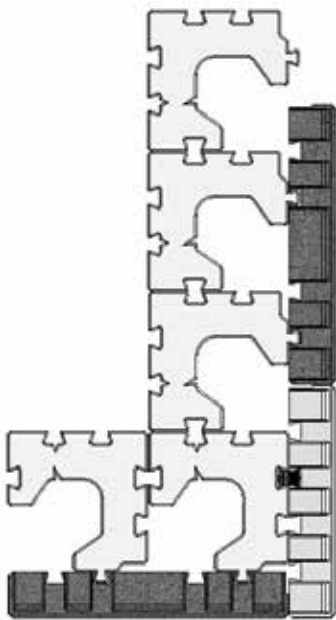

WITH VENEER E

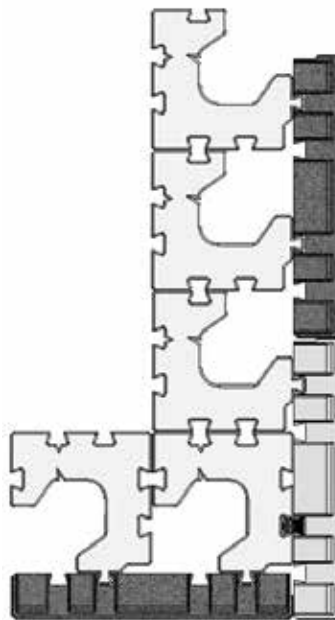

WITH VENEER F

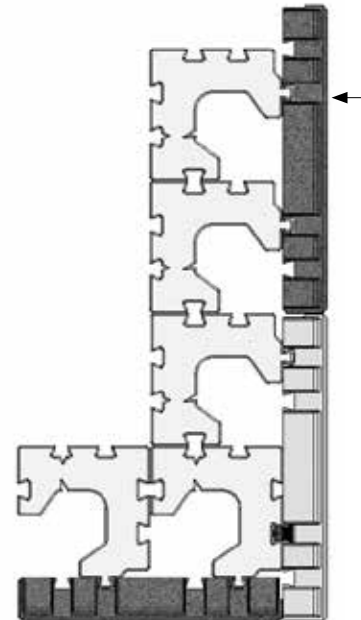

WITH VENEER G

## CONSTRUCTION OF A RETAINING WALL (CONT'D)

## BUILDING A 90° INNER CORNER

Building an inner corner is based on the principle illustrated opposite. The solidity of an inner corner is assured by the placement of a structural unit forming the back corner of the wall. This additional unit is anchored to the others with a Tandem Next universal connector.

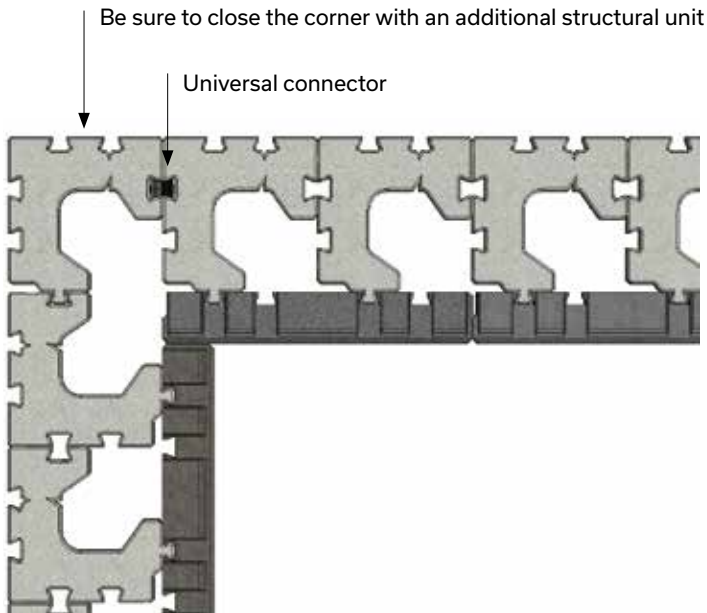

MELVILLE AND LAFITT TANDEM VENEER

## TANDEM NEXT RETAINING WALL CAPPING

Tandem Next retaining walls can be capped with different types of products:

- > Melville Plus 60 capping unit
- > Lafitt Plus 90 capping unit
- > Celtik Plus Straight 90 capping unit

The capping units must be glued to the last row of units, using an appropriate concrete adhesive. For the curved parts, certain elements must be bevelled to follow the curve of the wall.

## TANDEM NEXT DOUBLE-SIDED WALL

A double-sided wall is built without a slope and thus is vertical. Installation of a Tandem Next double-sided wall requires the use of veneer units, which are affixed to each side of the Tandem Next structural units. The basic principle is to build a Tandem Next wall and add veneer units in the back, affixing them with Tandem Next universal connectors in the vertical

position. The outer corners of a double-sided wall must be built by using corner veneer units. The flexibility of the Tandem Next system is based on the fact that the structural units can be positioned in several ways, ensuring that each veneer can be affixed to them by tenons or by universal connectors.

## TANDEM NEXT DOUBLE-SIDED WALL WITH TANDEM VENEER (MELVILLE, LAFITT)

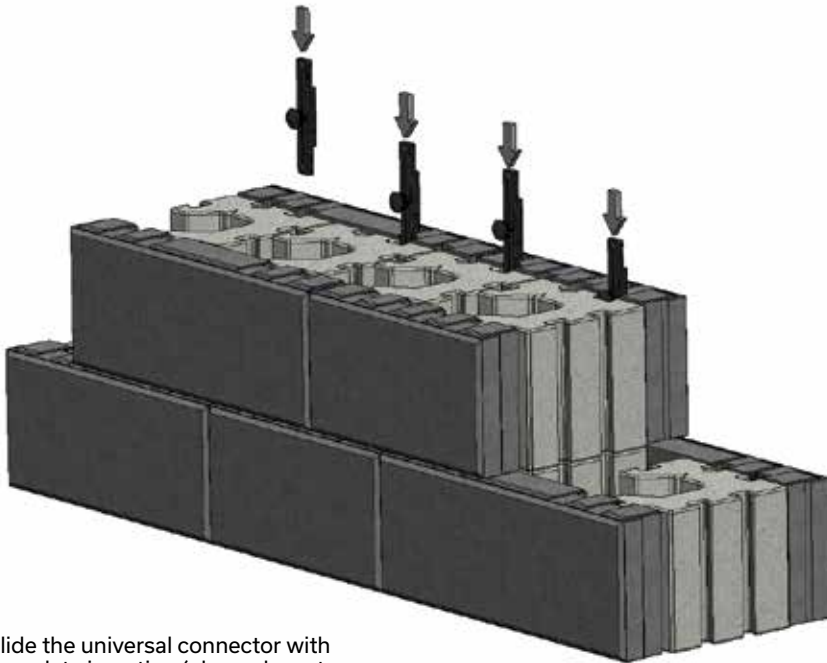

Slide the universal connector with complete insertion (always have two connectors per veneer)

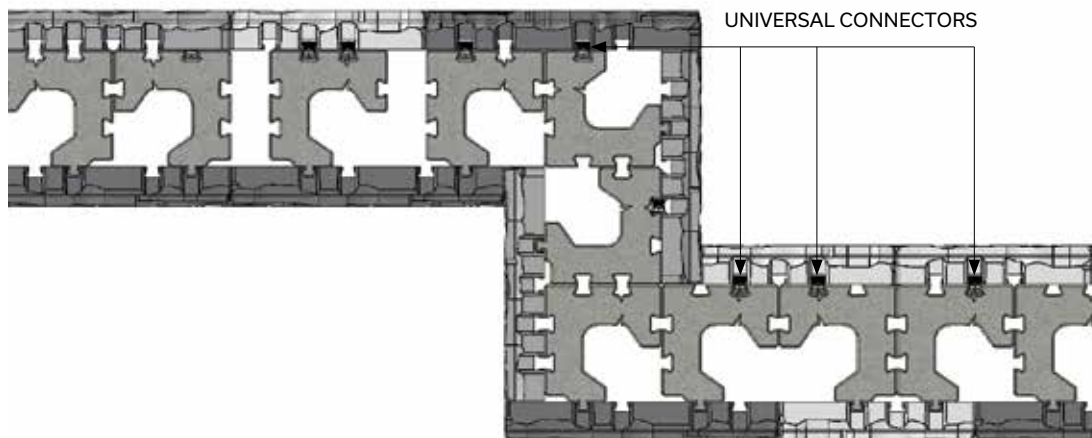

**CROSS-SECTION - TANDEM NEXT DOUBLE-SIDED WALL**

A typical cross-section of a double-sided wall is shown here. A Tandem Next double-sided wall rests on a first base course made with starter units installed side by side (the longest side). The units are placed at random, avoiding alignment of

the vertical joints of one row to another. It is essential to glue each row together (including the base course), using concrete adhesive. Spread the adhesive on the veneer units or the structural units or both.

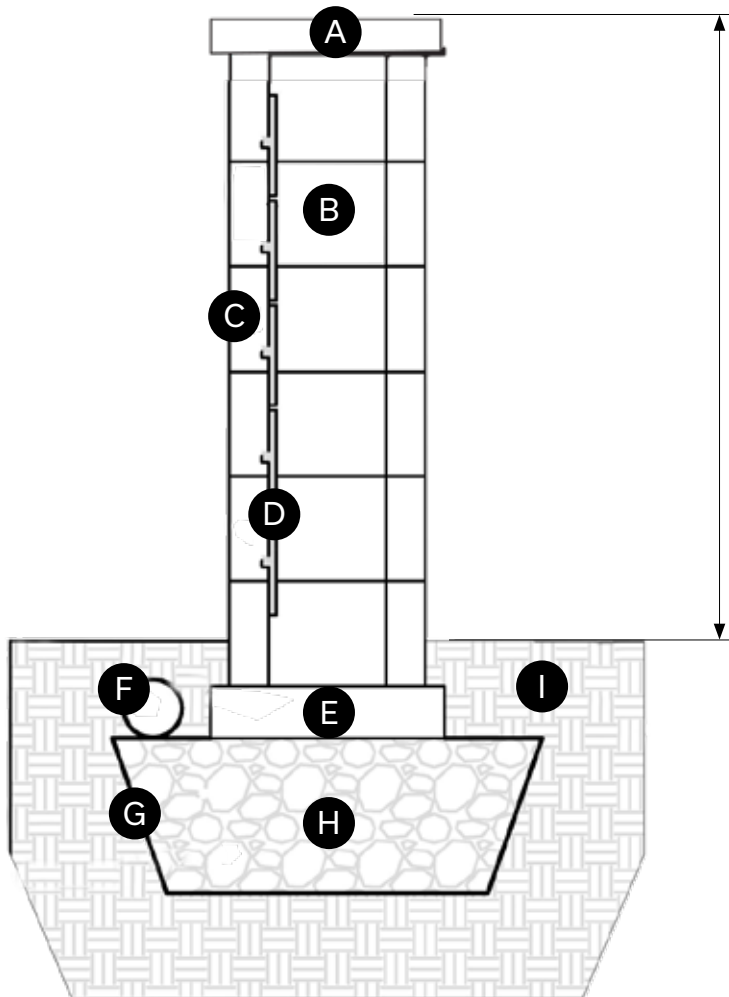

Maximum  
height  
1067 mm  
42 in.

- A Melville Plus wall step unit  
60 x 400 x 600 mm - 2 3/8 x 15 3/4 x 23 5/8 in.
- B Tandem Next wall structural unit  
180 x 201 x 201 mm with clear crushed stone  
20 mm - 3/4 in.
- C 180 mm veneer unit (Tandem System)
- D Universal connector Tandem Next
- E Starter unit 90 x 268 x 469 mm -  
3 1/2 x 10 1/2 x 18 1/2 in.
- F 100 mm Ø - 4 in. perforated drain pipe  
connected to sewer services
- G Geotextile membrane
- H 0 to 20 mm - 0 to 3/4 in. compacted granular  
foundation 300 mm - 12 in. minimum
- I Minimum buried depth 150 mm - 6 in.

**TANDEM NEXT DOUBLE-SIDED WALL END**

The construction details of a double-sided wall end are shown here. The veneer units must be cut to 268 mm - 10 1/2 in. to allow their installation. Only the smallest veneer unit must be used to finish a double-sided wall (unit A Tandem Next and unit E for Tandem veneers). It will be necessary to use two universal anchors to affix these elements. It is suggested to use concrete adhesive to glue together the elements forming the end of a wall, at each row.

The width of a Tandem Next double-sided wall is 335 mm - 13 3/16 in. and its maximum above-ground height is 1067 mm - 42 in.

**DOUBLE-SIDED TANDEM NEXT WALL CAPPING**  
 Tandem Next double-sided walls can be capped with different types of products: Melville Plus 60 step and Melville Plus 90 step.

**END OF WALL WITH TANDEM SYSTEM**

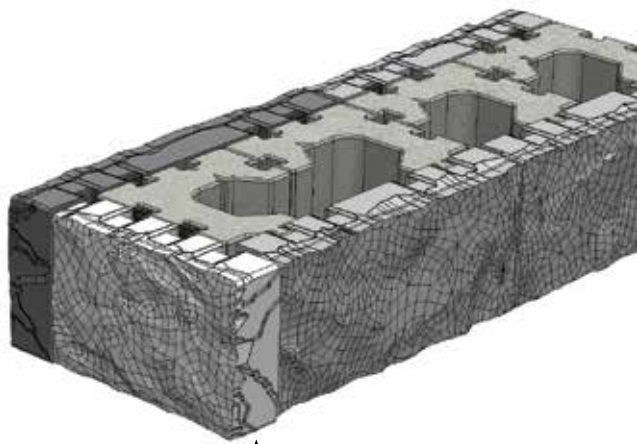

↑ Veneer with texture at the end (corner unit)

End of wall with veneers E and F

VENEER E ↓

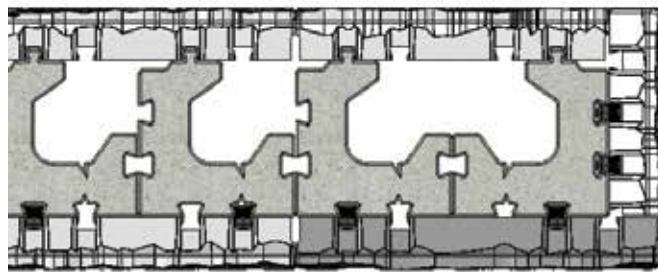

↑ VENEER F

End of wall with veneers F and G

VENEER F ↓

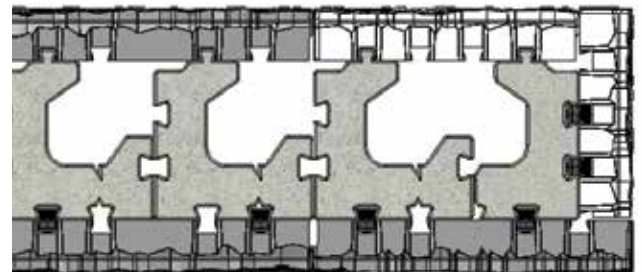

↑ VENEER G

**TANDEM NEXT COLUMN**

Columns can be built with the Tandem Next system. The veneer units are secured to the structural units with their tenon and with universal connectors. It is possible to create a space in the centre of the column so that a post can be inserted. However, this post must not be structural (for example, the post can serve as a lamppost).

Four column formats are possible:

- > 402 x 402 mm - 15 7/8 x 15 7/8 in.
- > 469 x 469 mm - 18 1/2 x 18 1/2 in.
- > 536 x 536 mm - 21 1/4 x 21 1/4 in.

A Tandem Next doubled-sided wall rests on a first base course made with starter units. We propose five types of construction of columns in different formats. This type of construction requires the creation of 90° corners. The position of the veneer is alternated by 90° from one row to another. It is essential to glue each row together (including the base course), using concrete adhesive. Spread the adhesive on the veneer units or the structural units or both. The construction of Tandem Next columns will require that only units with the same format be used. This will leave surpluses in the other formats on the same pallet.

The smallest column formats require cutting of the structural units (see drawings). To increase the overall solidity of a column, it is possible to install universal connectors at the centre of a column 536 x 536 mm (21 x 21 in.) that joins the four structural units. The empty spaces at the centre of the column must be filled with clean stone. The maximum height of a column is limited to 1080 mm - 42 1/2 in., which includes a portion buried in the ground of at least 150 mm - 6 in.

NOTE: We recommend using only Melville Tandem veneers to build columns.



MELVILLE TANDEM NEXT VENEER COLUMN

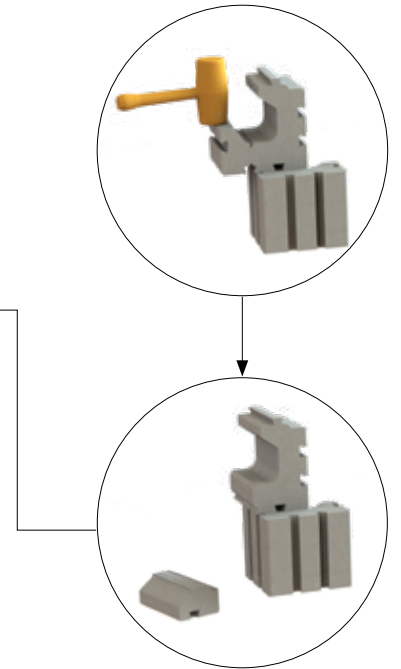
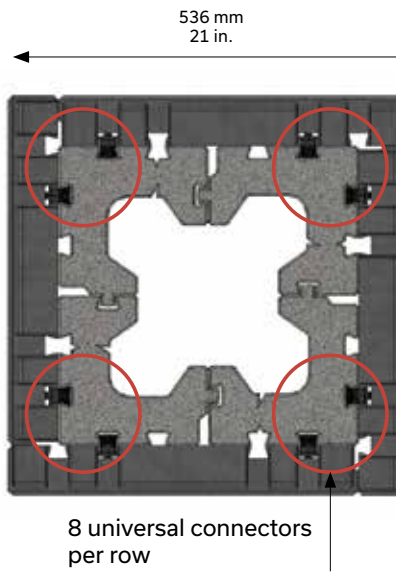
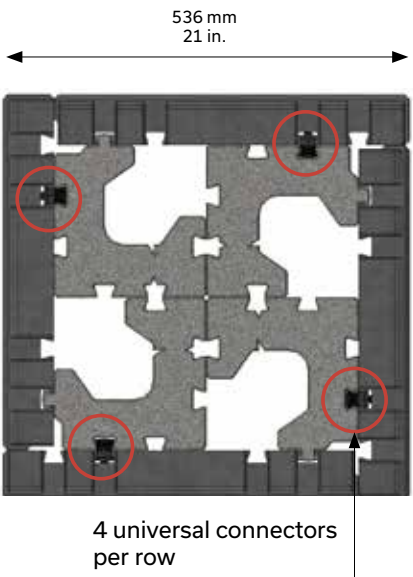
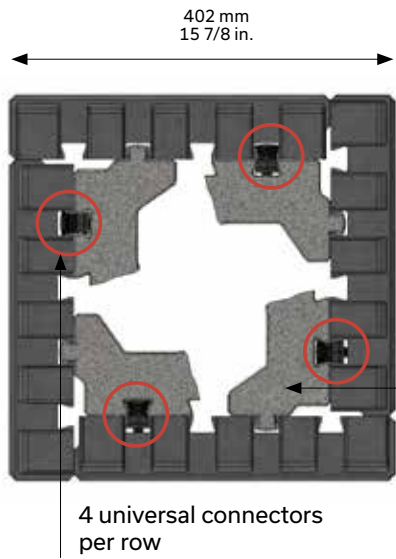
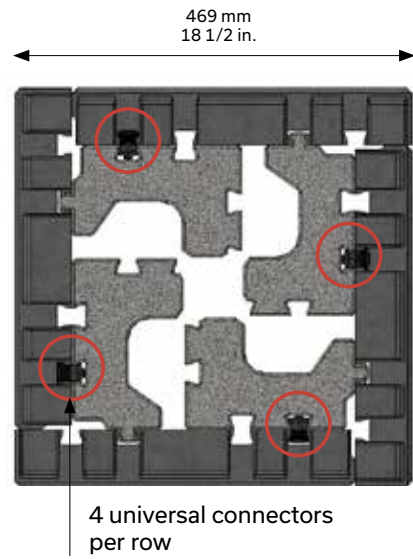

NOTE: The structural units can be joined with additional universal anchors in the centre to increase the strength of the column.

**BUILDING OF STAIRS**

The Tandem Next system allows the building of stairs. The construction of Tandem Next landings at each level of the stairs ensure maximum stability of the entire structure. We show the basic principles here.

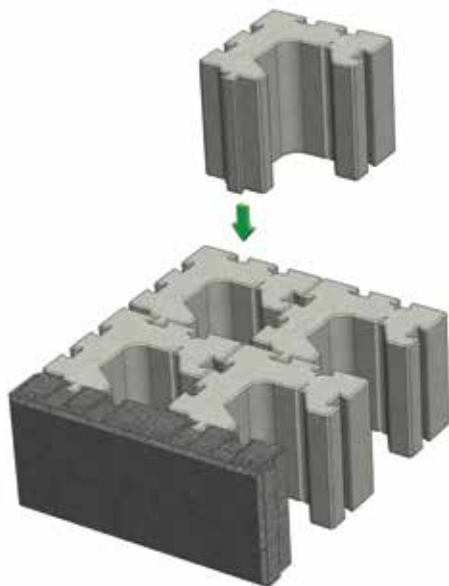

Install an additional structural unit by sliding the vertical tenon (male side) into the mortise (female side)

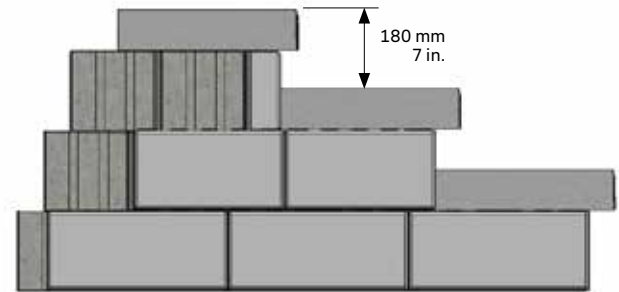

SIDE VIEW

A first landing is installed with the structural units attached together with universal connectors. The size of this landing varies with the number of stairs to be constructed. The veneer units are then placed all around and secured with universal anchors. A second landing is constructed above according to the same procedure by installing a series of stairs in front, secured with concrete adhesive. Construction continues until the last stair. The Tandem Next System stairs can be produced using different products: Melville Plus 60 step, Melville Plus 90 step and Lafitt Plus 90 step.

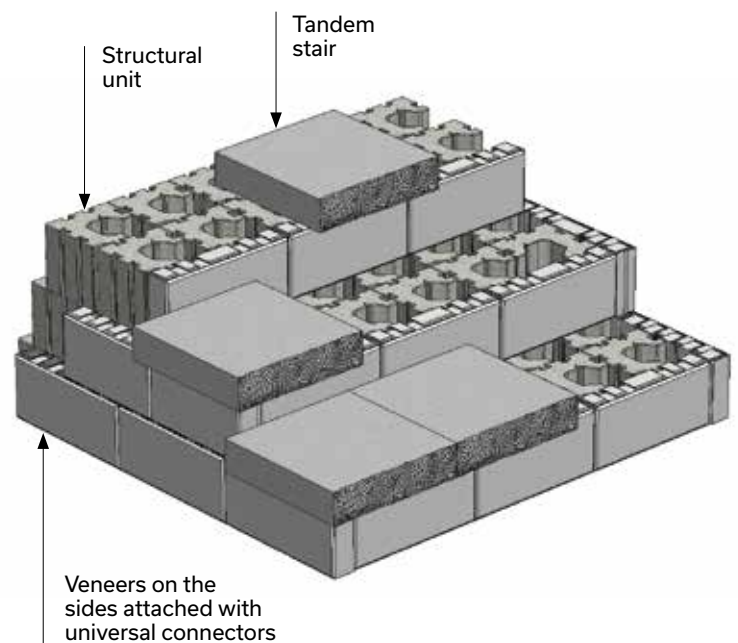

# Tandem System<sup>®</sup>

## SYSTEM ELEMENTS

### 90 MM VENEER UNITS

#### STRUCTURAL

Height: 90 mm - 3 9/16 in.  
Depth: 155 mm - 6 1/8 in.

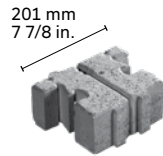

A

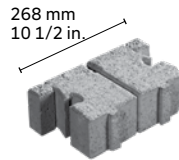

B

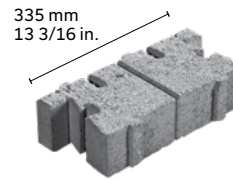

C

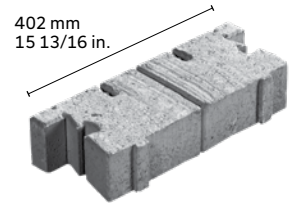

D

#### LAFITT

Height: 90 mm - 3 9/16 in.  
Depth: 67 mm - 2 5/8 in.



A

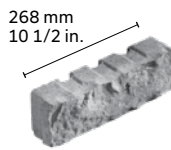

B

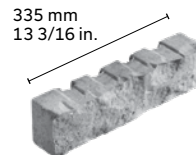

C

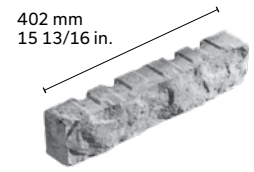

D

#### MELVILLE

Height: 90 mm - 3 9/16 in.  
Depth: 67 mm - 2 5/8 in.



A



B



C



D

### 180 MM VENEER UNITS

#### LAFITT

Height: 180 mm - 7 1/16 in.  
Depth: 67 mm - 2 5/8 in.

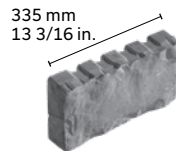

E

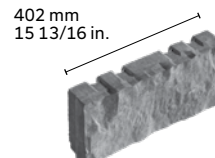

F

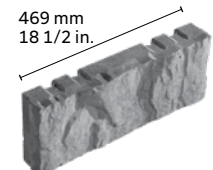

G

#### MELVILLE

Height: 180 mm - 7 1/16 in.  
Depth: 67 mm - 2 5/8 in.



E



F



G

**SYSTEM ELEMENTS**

**OTHER UNITS (SOLD SEPERATELY)**

**LAFITT PLUS STRAIGHT CAPPING**

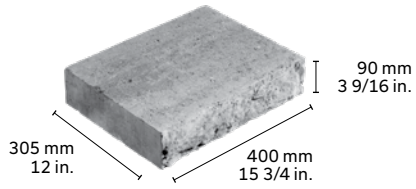

**LAFITT PLUS STEP**

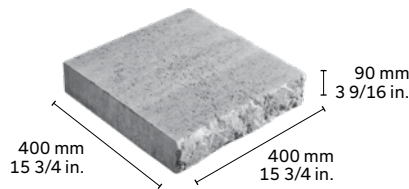

**MARCHE MELVILLE PLUS 90**

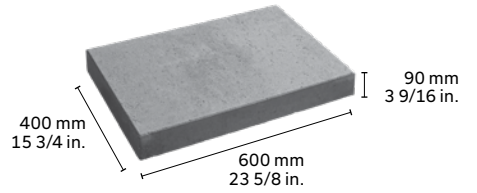

**MELVILLE PLUS STRAIGHT CAPPING**

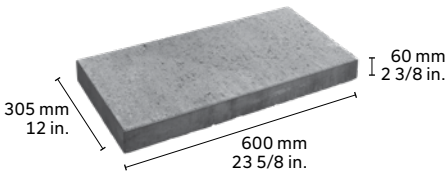

**MELVILLE PLUS 60 STEP**

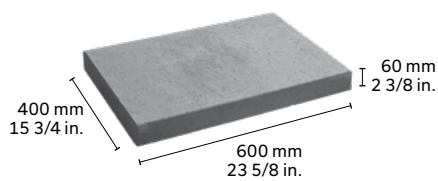

**STARTER UNIT**

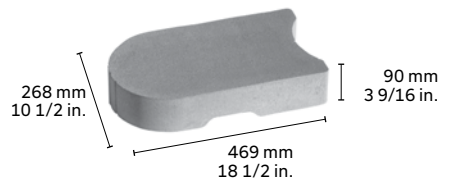

**ANCHORS AND CONNECTORS**

**SETBACK ANCHOR**



**DOUBLE-SIDED CONNECTOR**



**CORNER ANCHOR**



**TANDEM GRID CONNECTOR**



**OTHERS**

**TANDEM GRID PILLAR KIT**

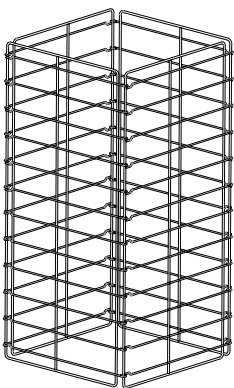

**TANDEM MODULAR GRID**

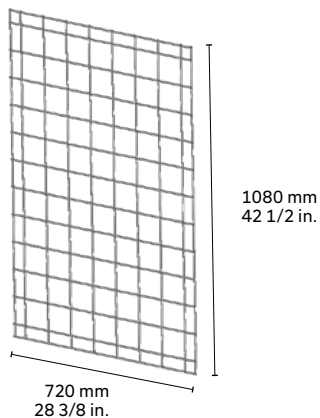

**TANDEM SHELF ANGLE**

64 x 64 x 2439 mm  
2 1/2 x 2 1/2 x 8 in.



Each Tandem Grid Pillar Kit comes with 1 bag of 200 Tandem grid connectors.

Each Tandem Modular Grid comes with 1 bag of 60 Tandem grid connectors, 10 screws #10 x 1 1/4 in. and 10 loop clamps.

UNIT ASSEMBLY



TANDEM 90

Tandem 90 units are 3 9/16 in. (height). For each structural unit, there is a veneer unit of the same length and height. The unit can be assembled using the dovetail joint (an interlocking male/ female system). Each structural unit has two vertical tenons (male side) and each veneer unit has at least two mortises (female side). The veneer units are joined to the structural units by simply sliding the mortises into the tenons to create the Tandem unit. There are two types of veneer units, Lafitt and Melville Tandem units. The total depth of the unit is 222 mm - 8 3/4 in.

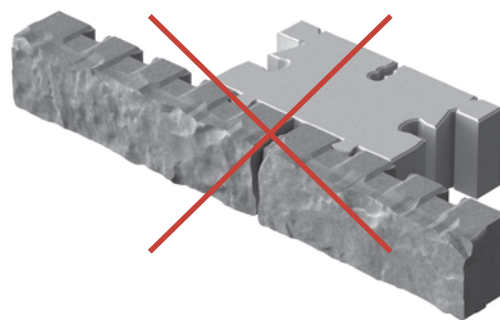
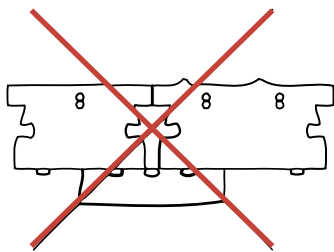
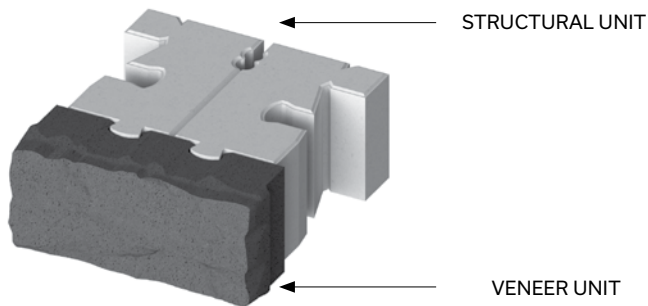

**ATTENTION:** In general, do not overlap two veneer units on a single structural unit of the same height, and do not overlap two structural units on a single veneer unit.

# Building a Tandem Retaining Wall

## STARTER UNIT

The first course of the Tandem wall is built using the Tandem wall starter unit. This is to be installed directly on the granular base foundation and levelled. The unit is bevelled to make it easy to install curved walls.

The use of starter units is strongly recommended given that the Tandem units (structural and veneer units) can then be placed on a uniform base ensuring overall wall stability.

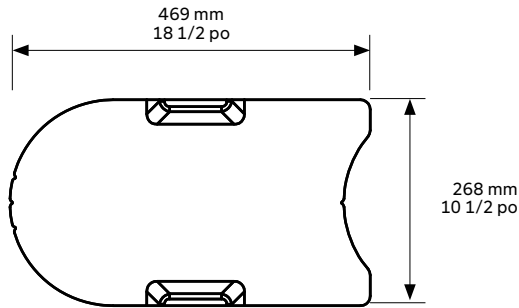

STARTER UNIT

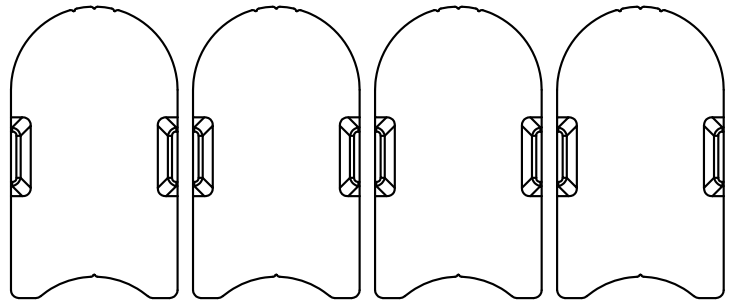

INSTALLATION OF STARTER UNITS  
PLAN VIEW

## PREASSEMBLY

90 unit: It is best to pre-assemble veneer and structural units before beginning to stack them in building the wall. Once pre-assembled, Tandem units are randomly installed on starter units, using the four different sizes.

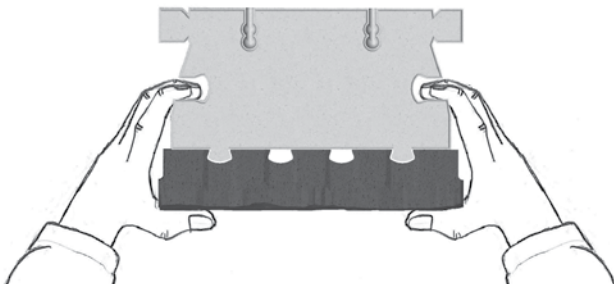

RECOMMENDED HANDLING FOR THE TANDEM 90 UNIT



STRUCTURAL UNIT



VENEER UNIT

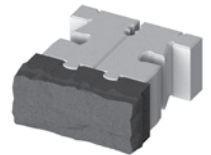

TANDEM UNIT



## ANCHOR SYSTEM

The way in which the setback anchor is positioned in the Tandem wall system determines the slope of the wall. This positioning is what allows for either vertical or sloped walls.

Generally, at least one setback anchor must be installed per Tandem 90 unit, to make sure the wall is stable. Setback anchors come with or without blades. No-blade setback anchors are used in curved walls. Both types of anchor can be used in straight walls.

Allowable heights<sup>1</sup>: 650 mm - 26 in. without a slope (0°, vertical);  
1 050 mm - 42 in. with a slope of 9°

For a 9° of slope, the setback per row of 90 mm is 14 mm - 9/16 in.

<sup>1</sup> Maximum height of the wall including the buried portion of 150 mm - 6 in. without additional load or embankment above the wall

### THERE ARE SEVERAL WAYS TO BUILD A TANDEM RETAINING WALL:

- > By using only Lafitt or Melville Tandem 90 units
- > By using only Lafitt or Melville Tandem 180 units

It is possible to use Lafitt and Melville Tandem Veneer units in the same wall.

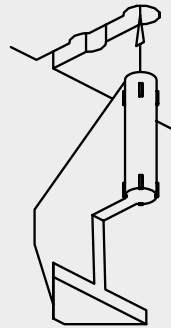

Position for building a wall on a 9° slope.  
Maximum height of 1.05 m - 42 in.

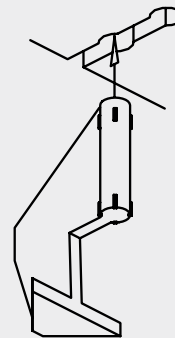

Position for building a vertical wall.  
Maximum height of 0.65 m - 26 in.

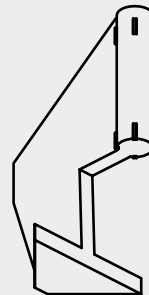

C1 - Base model

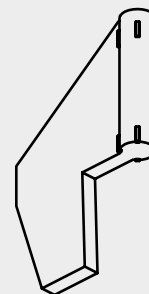

C2 - Model without blades



**CROSS-SECTION - LAFITT AND MELVILLE TANDEM 90 WALL**

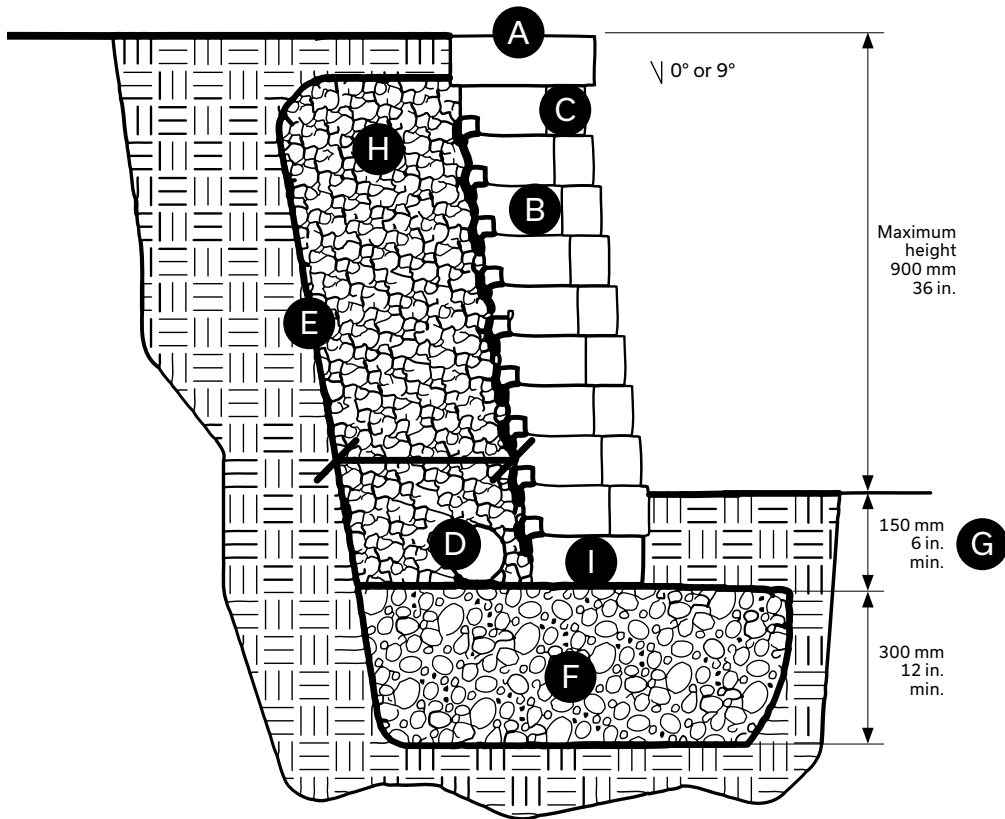

**LAYING PATTERN**

LINEAR PATTERN  
100% Tandem 90

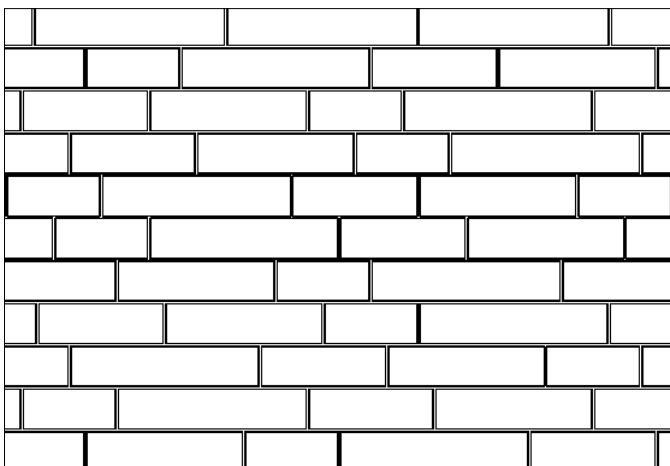

- A** Straight capping unit  
90 x 305 x 400 mm - 3 9/16 x 12 x 15 3/4 in. OR  
60 x 305 x 600 mm - 2 3/8 x 12 x 23 5/8 in.
- B** Structural unit 90 x 155 mm x variable  
(201, 268, 335 ou 402 mm) - 3 9/16 x 6 1/8 in. x  
variable (7 7/8, 10 1/2, 13 3/16, 15 13/16 in.)
- C** Veneer 90 mm unit (Tandem System)
- D** 100 mm Ø - 4 in. perforated drain pipe  
connected to sewer services
- E** Geotextile membrane
- F** 0 to 20 mm - 0 to 3/4 in. compacted granular  
foundation 300 mm - 12 in. minimum
- G** Minimum buried depth 150 mm - 6 in.
- H** Clean stone 20 mm - 3/4po, 300 mm minimum
- I** Starter unit 90 x 268 x 469 mm -  
3 1/2 x 10 1/2 x 18 1/2 in.

# BUILDING A RETAINING WALL

## STRAIGHT WALL

To build straight Tandem walls, install the units randomly, using equal numbers of all unit sizes according to the typical cross-section and installation pattern associated with each type of walls.

When building a Tandem wall, avoid aligning vertical joints between rows as much as possible. Allow a minimum overlap of about 67 mm - 2 3/4 in. between units to make sure the vertical joints do not line up.

Lafitt Tandem wall (plan view)

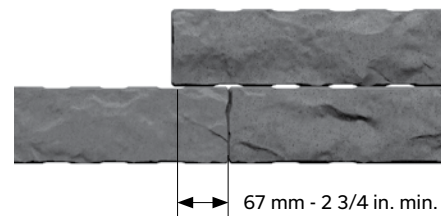
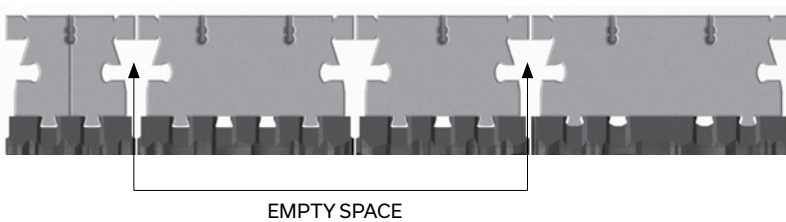

## CURVED WALL

Using some Tandem units yields the minimum following curves:

	LAFITT TANDEM 90	MELVILLE TANDEM 90
Convex curves (outside)	1.5 m - 5 ft.	1.8 m - 6 ft.
Concave curves (inside)	1.2 m - 4 ft.	1.8 m - 6 ft.

Curved sections of walls must generally be built using the smallest units.

For a curved Tandem 90 wall, use units A, B and C. Their ends are bevelled to make it easier to install the curved wall.

Since Melville Tandem Veneers all have a textured side, the minimum bend radius is greater.

Remember that there will be a surplus of longer units for the remainder of the wall.

In building convex curves (outer curve), the wings of structural units may have to be cut off.

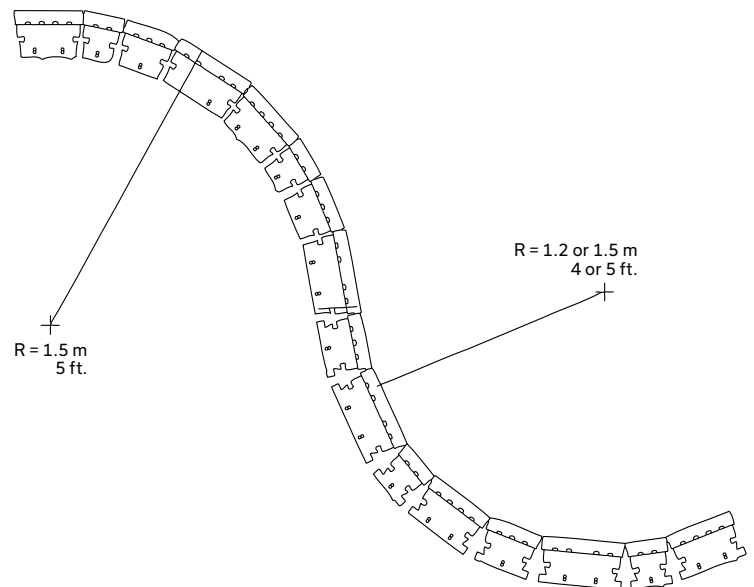
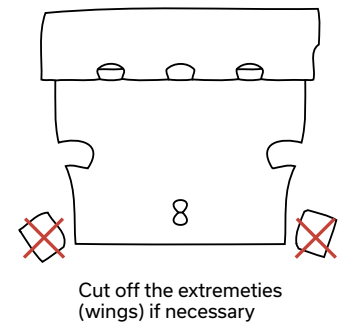

# BUILDING A RETAINING WALL

## 90° CORNER WALL

When building a retaining wall, it is best to start with a corner to avoid breaks and alignment of vertical joints. Specially designed veneer units are needed to build a 90° corner. These units are called textured end units or corner veneer units.

### LAFITT TANDEM

A Lafitt Tandem 90 cube contains 18 textured end veneer units per row. To form the corner, use B, C or D veneer units.

### MELVILLE TANDEM

All of Melville Tandem Veneers have one textured side.

Stacking position on pallets (with a textured end)

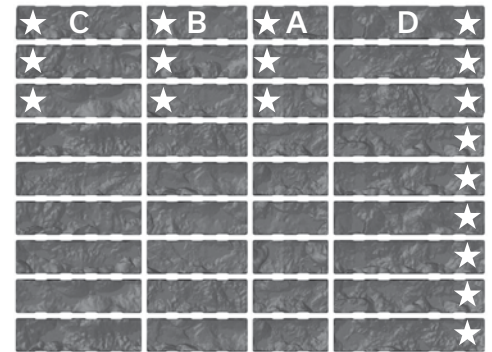

LAFITT TANDEM – 90 MM UNITS

## LAFITT AND MELVILLE 90 MM 90° OUTER CORNER - BASIC PRINCIPLES

An outer corner is created using veneer units with the textured end out.

These units are reversible to form both left and right corners. For each course, the veneer that forms the corner is affixed to the structural unit using corner connectors designed specifically for this purpose. It is simply a question of alternating the placement of units from one course to the next. We recommend adhering the elements used to make the corner of each row using Techniseal concrete adhesive.

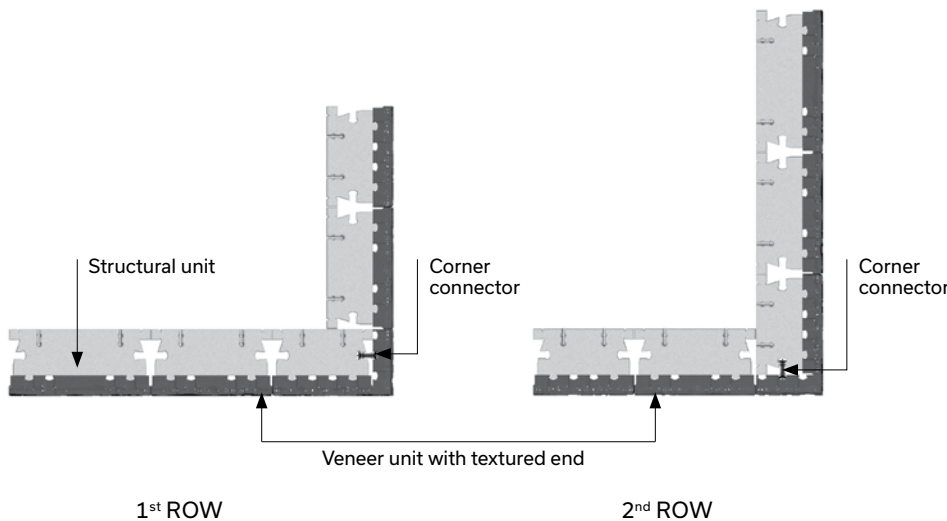

Spread the adhesive on the veneer units, or the structural units or on both

**LAFITT AND MELVILLE 90 MM 90° OUTER CORNER - DETAILS**

There are three ways of building a corner using Tandem 90 mm units:

**OPTION 1**

Use a corner veneer unit with a textured end B uncut and begin the wall perpendicularly, leaving an empty space that will be backfilled with clean stone.

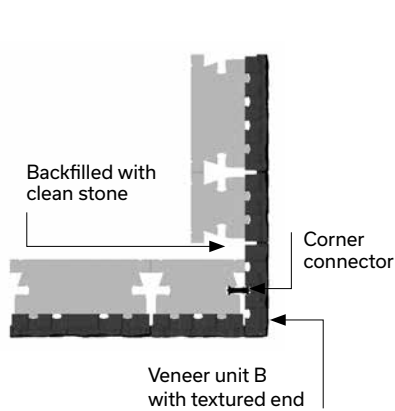

**OPTION 2**

Use a corner veneer unit with a textured end C or D, uncut, attached to a structural unit A cut in half.

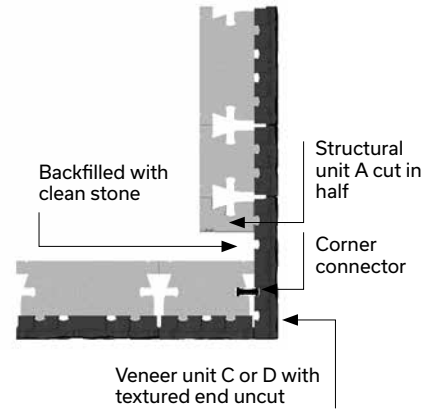

**OPTION 3**

Use a corner veneer unit with a textured end B, C or D, cut at 222 mm - 18 3/4 in. and begin the wall perpendicularly, pressing it up against the existing wall. Gently hammer the freshly cut side to obtain a similar finish as the other sides.

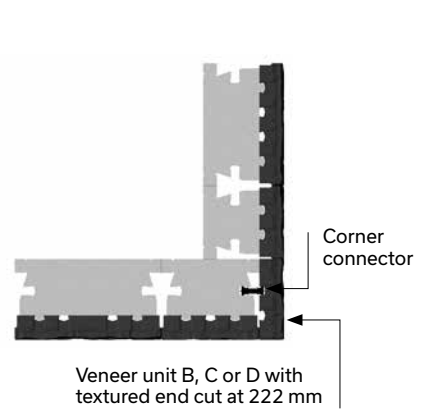

## INTERIOR CORNER - BASIC PRINCIPLES

Build a Lafitt and Melville Tandem inner corner according to the principle shown here using Tandem 90 units C or D and 180 units E, F or G.

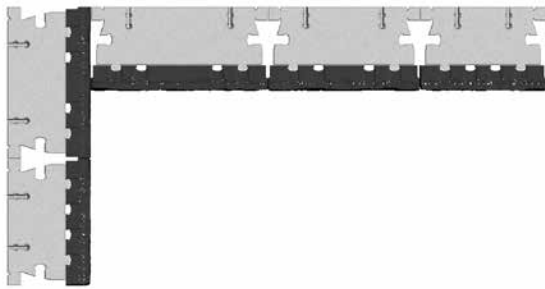

1<sup>st</sup> ROW

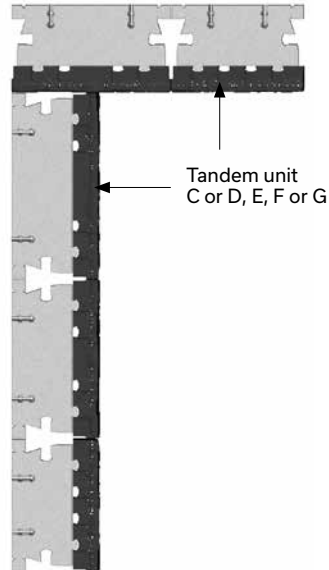

2<sup>nd</sup> ROW

### 45° CORNER

It is also possible to build corners on a 45° angle. Simply cut each Tandem unit used to make the corner on a 22.5° angle. These Tandem units must be adhered together using Techniseal concrete adhesive on the horizontal and vertical sides.

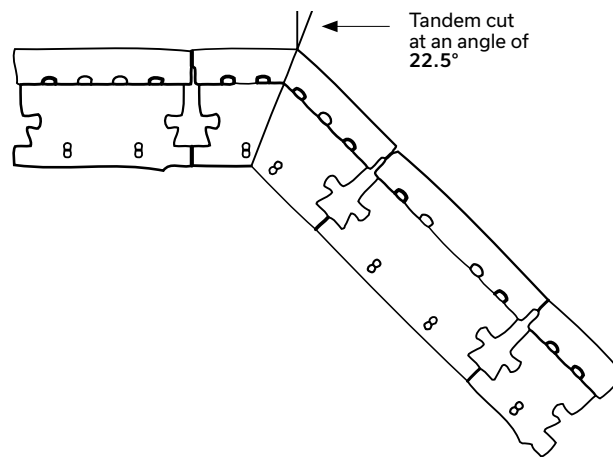

## RETAINING WALL CAPPING

### LAFITT AND MELVILLE TANDEM WALLS

The Lafitt Tandem retaining wall is completed using **Lafitt capping units** (90 x 305 x 400 mm).

The Melville Tandem wall is finished with the use of **Melville capping units** (60 mm x 305 mm x 600 mm).

To cap a wall with a 90° corner, capping units must be cut at a 45° angle (see illustration).

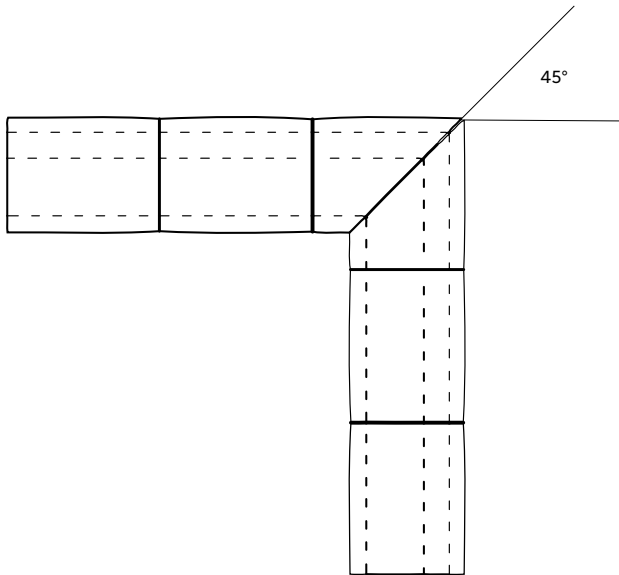

**Lafitt or Melville capping units** are also used to cap curved walls. The units must be bevelled on site to match the final shape of the wall.

**OPTIONS:** Straight capping units from the Celtik wall system unit can also be used to highlight the wall's finish (different colours and textures).

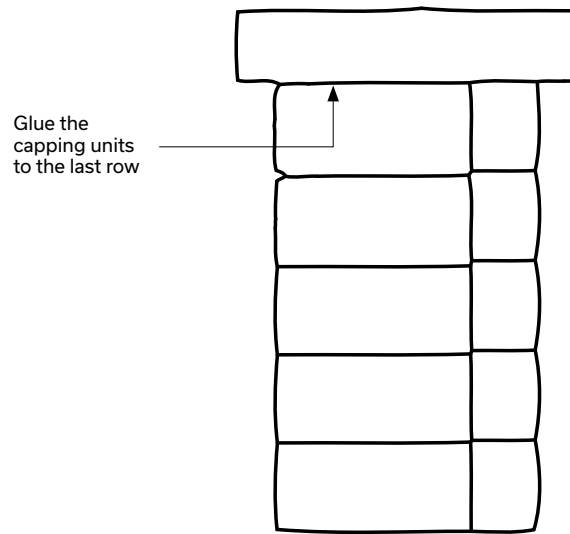

NOTE: All capping units must be glued to the last row of Tandem units using Techniseal concrete adhesive. Make sure the surface is clean, so that the capping can be glued to the top course with Techniseal concrete adhesive.

# Building a Double-Sided Wall

## DOUBLE-SIDED TANDEM UNIT ASSEMBLY



Installing a double-sided wall requires the use of two veneer units held together using connectors. Connectors are inserted into the mortises on the veneer units thus connecting them two by two in order to create the double-sided Tandem unit. The work is complete once 20 mm - 3/4 in. clean stone is placed between the veneers of every other course, and the capping unit is installed. Lafitt and Melville Tandem 90 and 180 veneer units can be used to build straight or curved double-sided walls, as well as 90° corners.

### ALLOWABLE HEIGHTS

The Tandem wall system can be used to build a double-sided wall with a maximum above-ground height of 711 mm - 28 in. The wall is built completely vertical without a slope.

## STARTER UNITS

To build the double-sided Tandem wall, begin by placing the starter unit directly on the granular base perpendicular to the wall and leveling it.

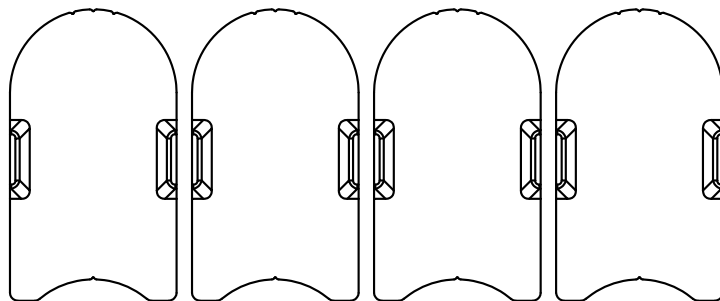
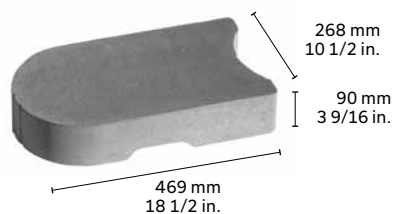

INSTALLATION OF STARTER UNITS  
PLAN VIEW



PLASTIC CONNECTORS

TANDEM DOUBLE-SIDED UNITS 90 AND 180 mm

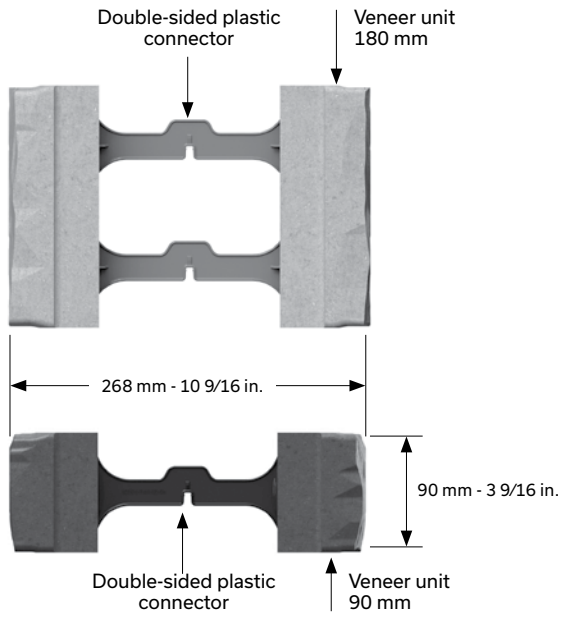

3-D VIEW

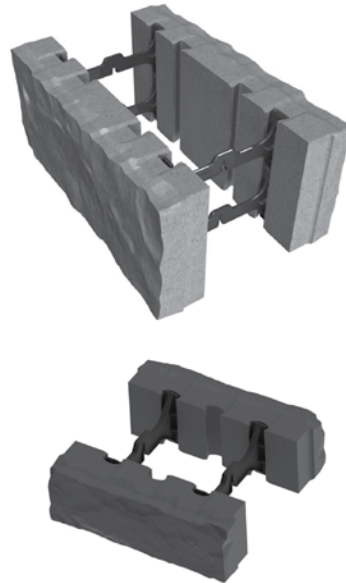

# BUILDING A DOUBLE-SIDED WALL

## DETAILS

### THERE ARE SEVERAL WAYS TO BUILD A DOUBLE-SIDED WALL:

- > Using only Lafitt or Melville Tandem 90 units
- > Using only Lafitt or Melville Tandem 180 units
- > Using a combination of Lafitt or Melville Tandem 90 and 180 units together

To build a solid structure, the empty space inside the double-sided Tandem unit with plastic connectors must be filled with 20 mm - 3/4 in. clean stone on every second row. Before installing the capping, tap lightly on each side of the wall with a rubber hammer to help compact the aggregate between the veneer units.

Double-sided Tandem units are randomly installed on starter units, using an equal number of all units. The same installation

patterns as for retaining walls are used here (see the installation patterns in the RETAINING WALL section). Each veneer unit of the first row must be glued to the starter units with Techniseal concrete adhesive.

#### QUANTITY OF CONNECTORS REQUIRED:

##### Lafitt and Melville Tandem 90 wall

7 connectors per sq. ft of double-sided wall (74 connectors per m<sup>2</sup>) based on one of the sides of the wall.

##### Lafitt and Melville Tandem 180 wall

5.5 connectors per sq. ft of double-sided wall (57 connectors per m<sup>2</sup>) based on one of the sides of the wall.

WE RECOMMEND GLUING ALL OF THE ROWS TOGETHER FOR A DOUBLE-SIDED WALL USING LAFITT AND MELVILLE TANDEM.

## 90 mm STRAIGHT DOUBLE-SIDED WALL

### DOUBLE-SIDED LAFITT AND MELVILLE TANDEM WALL WITH 90 mm VENEER UNITS AND PLASTIC CONNECTORS

When building a straight wall, assemble veneer units of the same size using the double-sided connector. Because the veneer units come in different lengths, several layouts are possible.

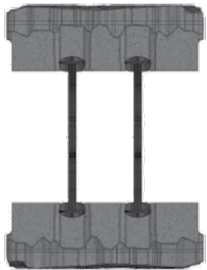

UNITS A-A  
90 x 67 x 201 mm  
3 9/16 x 2 5/8 x 7 7/8 in.



UNITS B-B  
90 x 67 x 268 mm  
3 9/16 x 2 5/8 x 10 1/2 in.

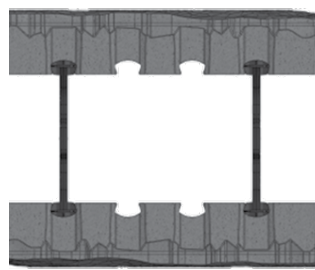

UNITS C-C  
90 x 67 x 335 mm  
3 9/16 x 2 5/8 x 13 3/16 in.

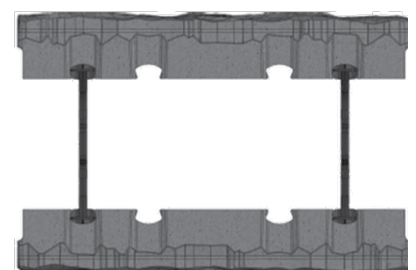

UNITS D-D  
90 x 67 x 402 mm  
3 9/16 x 2 5/8 x 15 13/16 in.

**TYPICAL CROSS-SECTION - DOUBLE-SIDED 90 mm VENEER UNITS**

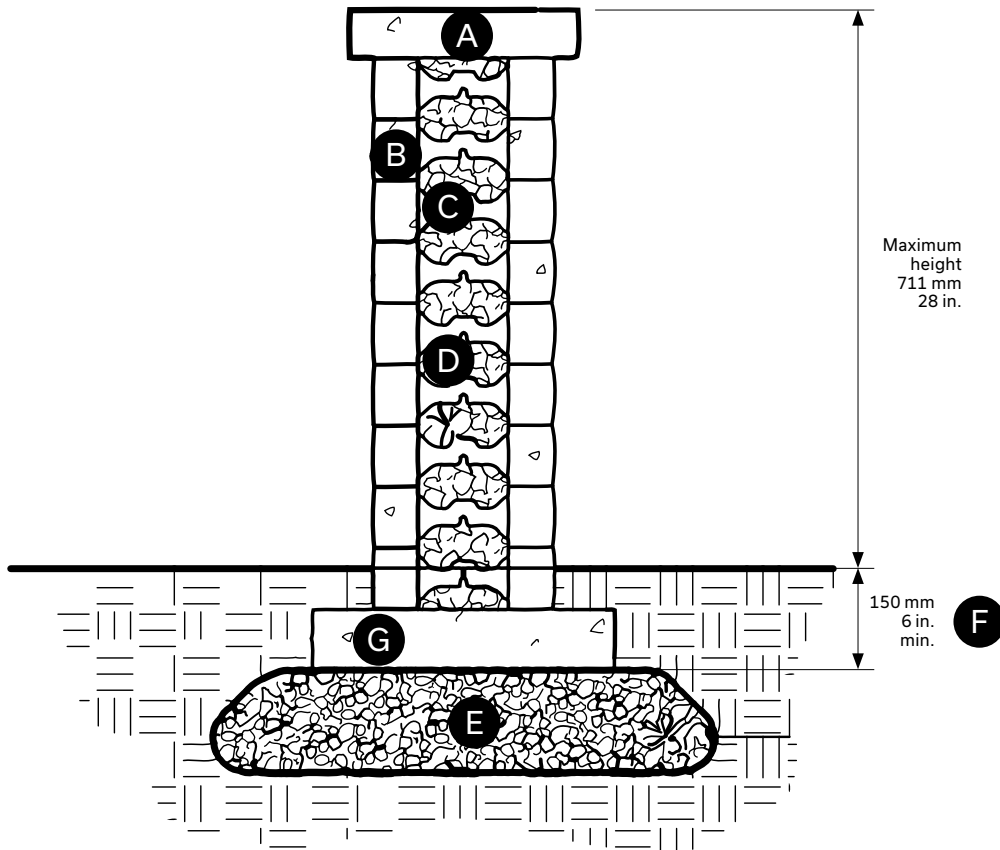

- A** Melville Plus capping unit  
60 x 305 x 600 mm - 2 3/8 x 12 x 23 5/8 in.
- B** 90 mm veneer unit (Tandem System)
- C** Double-sided connector
- D** Clean stone 20 mm - 3/4 in., 300 mm minimum
- E** 0 to 20 mm - 0 to 3/4 in. compacted granular foundation 300 mm - 12 in. minimum
- F** Minimum buried depth 150 mm - 6 in.
- G** Tandem Next starter unit 90 x 268 x 469 mm - 3 9/16 x 10 1/2 x 18 1/2 in.

# BUILDING A DOUBLE-SIDED WALL

## 180 mm STRAIGHT DOUBLE-SIDED WALL

### DOUBLE-SIDED LAFITT AND MELVILLE TANDEM WALL WITH 180 mm VENEER UNITS AND PLASTIC CONNECTORS

When building a straight wall, assemble veneer units of the same size using the double-sided connector. Because the veneer units come in different lengths, several layouts are possible.

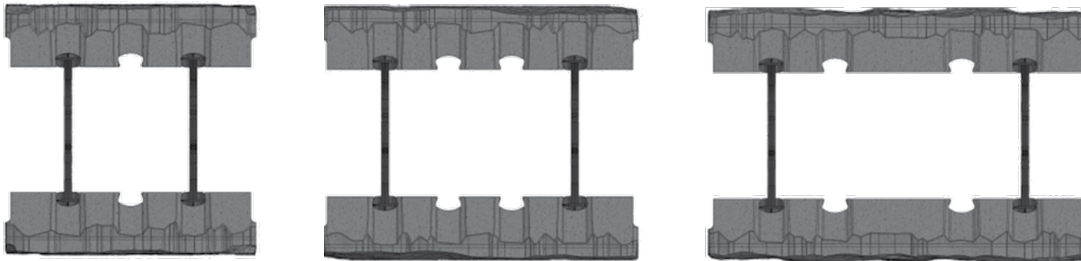

NOTE: Tandem 180 wall units must be assembled using pairs of double-sided connectors installed one on top of the other for greater stability.

UNITS E-E  
180 x 67 x 335 mm  
7 1/16 x 2 5/8 x 13 3/16 in.

UNITS F-F  
180 x 67 x 402 mm  
7 1/16 x 2 5/8 x 15 3/16 in.

UNITS G-G  
180 x 67 x 469 mm  
7 1/16 x 2 5/8 x 18 1/2 in.

## TYPICAL CROSS-SECTION - DOUBLE-SIDED 180 mm VENEER UNITS

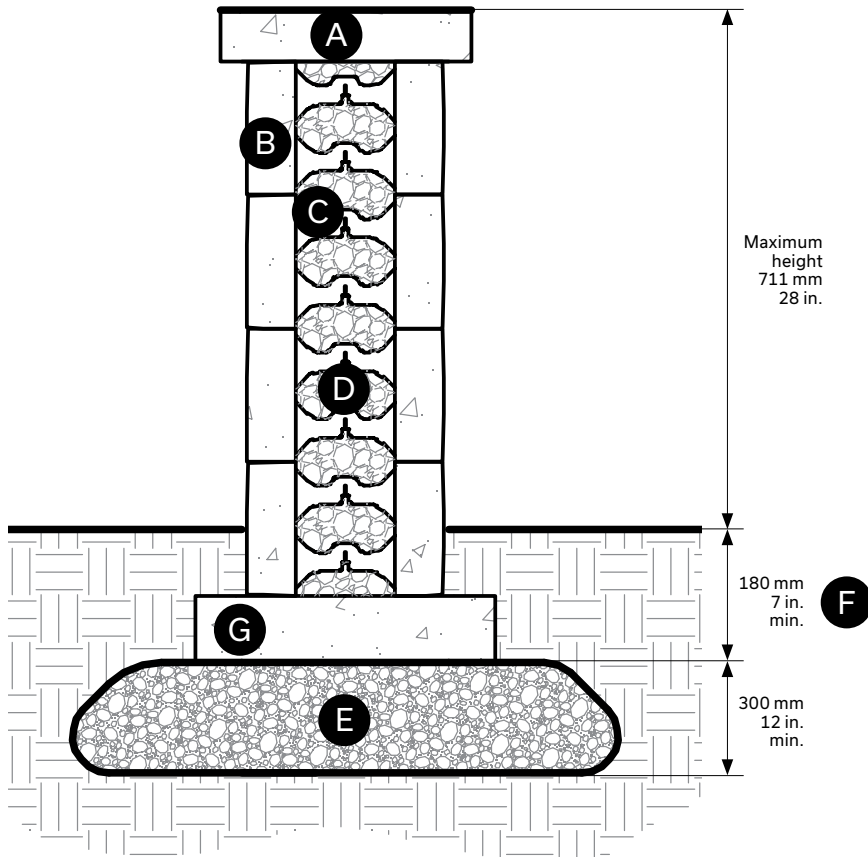

Maximum height  
711 mm  
28 in.

180 mm  
7 in.  
min. F

300 mm  
12 in.  
min. E

- A Melville Plus capping unit  
60 x 305 x 600 mm - 2 3/8 x 12 x 23 5/8 in.
- B 180 mm veneer unit (Tandem System)
- C Double-sided plastic connector
- D Clean stone 20 mm - 3/4 in., 300 mm minimum
- E 0 to 20 mm - 0 to 3/4 in. compacted granular foundation 300 mm - 12 in. minimum
- F Minimum buried depth 150 mm - 6 in.
- G Tandem Next starter unit 90 x 268 x 469 mm - 3 9/16 x 10 1/2 x 18 1/2 in.

**TYPICAL CROSS-SECTION - DOUBLE-SIDED 90 mm and 180 mm VENEER UNITS**

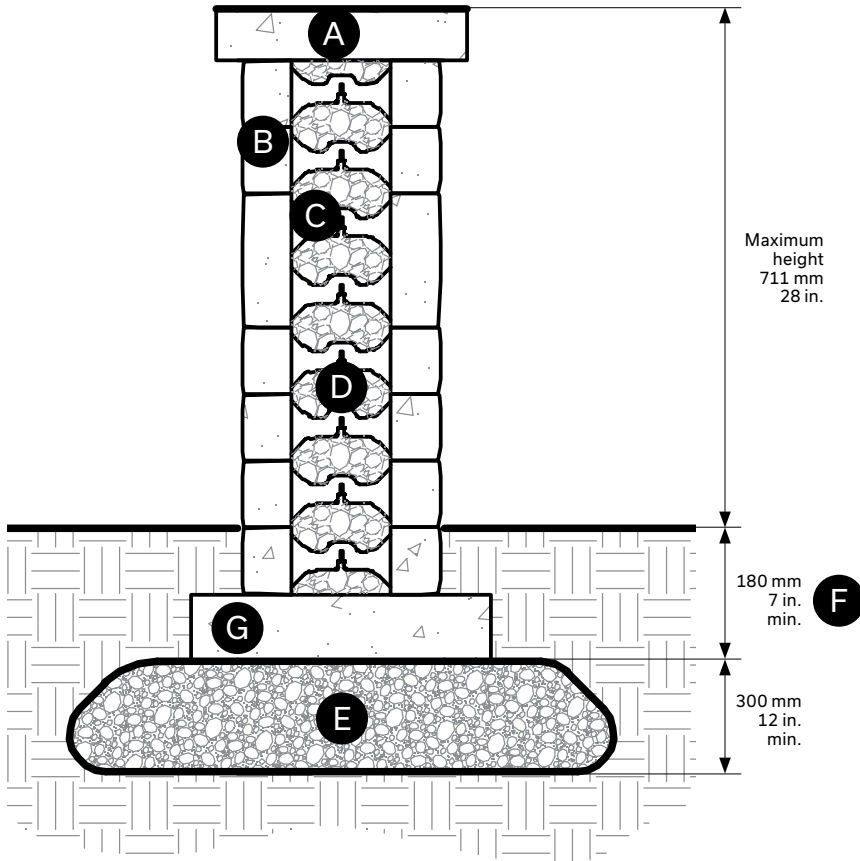

- Ⓐ Melville Plus capping unit  
60 x 305 x 600 mm - 2 3/8 x 12 x 23 5/8 in.
- Ⓑ 90 mm or 180 mm veneer unit (Tandem System)
- Ⓒ Double-sided plastic connector
- Ⓓ Clean stone 20 mm - 3/4 in., 300 mm minimum
- Ⓔ 0 to 20 mm - 0 to 3/4 in. compacted granular foundation 300 mm - 12 in. minimum
- Ⓕ Minimum buried depth 150 mm - 6 in.
- Ⓖ Tandem Next starter unit 90 x 268 x 469 mm - 3 9/16 x 10 1/2 x 18 1/2 in.

# BUILDING A DOUBLE-SIDED WALL

## 90 mm CURVED DOUBLE-SIDED WALL

### CURVED DOUBLE-SIDED LAFITT AND MELVILLE TANDEM WALL WITH 90 mm VENEER UNITS AND PLASTIC CONNECTORS

To build a curved double-sided wall, while maximizing results and minimizing sizes, only the following pairs of veneer units are recommended for use:

A-A, A-B, B-B and B-C for 90 mm units and E-E, E-F, F-F and F-G for 180 mm units. Consequently, there will be more D veneer units for the remainder of the wall. Some units may have to be cut to fit perfectly into the selected curve. The design flexibility of double-sided units means that connectors can be inserted in all unit mortises, providing for better adjustment in creating curves with different radii.



UNITS A-B

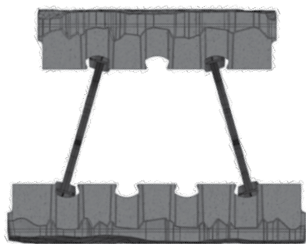

UNITS B-C

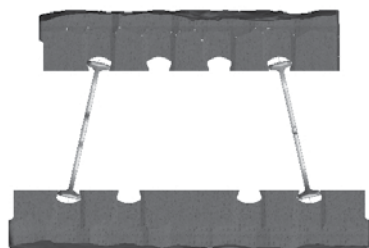

UNITS E-F

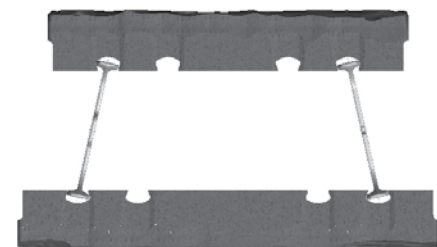

UNITS F-G

The minimum curves possible for the Lafitt Tandem wall:  
90 mm = 1.5 m - 5 ft  
180 mm = 1.8 m - 6 ft

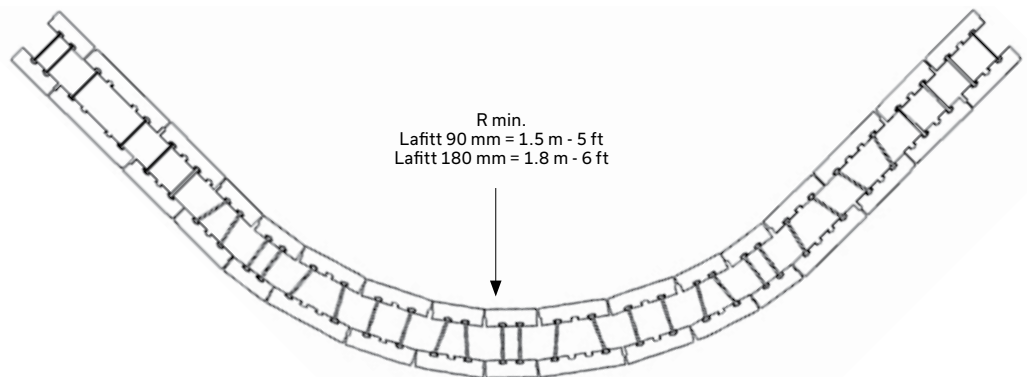

CURVED TANDEM WALL WITH PLASTIC CONNECTORS

**90 mm DOUBLE-SIDED WALL END**

**END OF DOUBLE-SIDED LAFITT AND MELVILLE TANDEM WALL WITH PLASTIC CONNECTORS**

The end of a double-sided Tandem 90 wall is built using a textured end veneer unit A installed on the end of the wall.

To ensure solid corner assembly, two double-sided connectors are overlapped in a cross shape and inserted into the mortises on the veneer units. The first connector connects the two double-sided wall veneer units, while the perpendicular connector connects the textured end veneer unit that forms the end of the wall. Glue every course forming the end of the wall using Techniseal concrete adhesive.

The end of a double-sided Tandem 180 wall is built using a textured end veneer unit E cut at 201 mm and installed on the end of the wall.

Connectors installed in a cross shape



ISOMETRIC VIEW

ASSEMBLY FOR DOUBLE-SIDED 90 mm WALL: END OF WALL

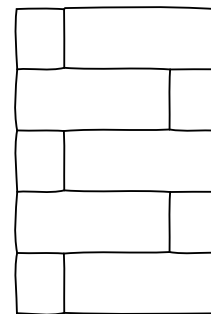
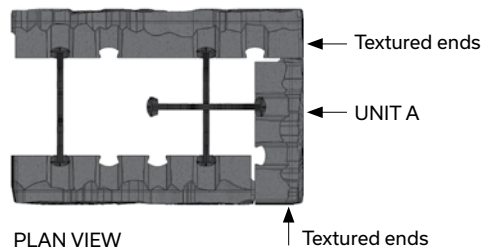

END OF WALL - SIDE VIEW

ASSEMBLY FOR DOUBLE-SIDED 180 mm WALL: END OF WALL

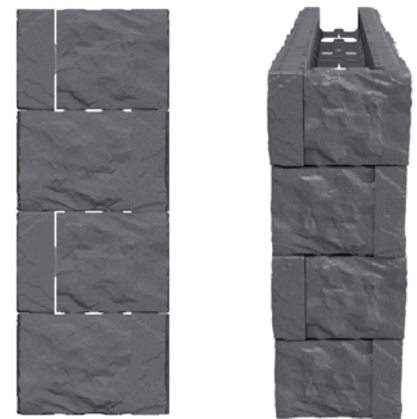
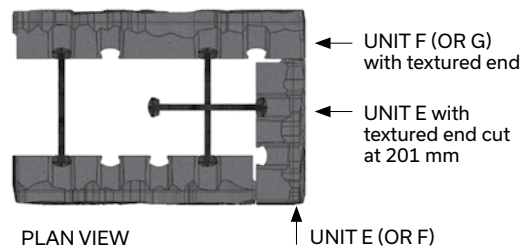

ELEVATION VIEW

**END OF A DOUBLE-SIDED LAFITT AND MELVILLE TANDEM DOUBLE 90 AND 180 WALL**

The end of a double-sided 90 and 180 wall is built by smoothly combining the two kinds of construction (90 and 180) for a wall end, described previously in this document. To build an end for a wall that mixes Tandem 90 and 180 units in the same wall, for each given row height, use units of the same height.



# BUILDING A DOUBLE-SIDED WALL

## DOUBLE-SIDED WALL WITH 90° CORNERS

### DOUBLE-SIDED WALL WITH 90° CORNERS AND PLASTIC CONNECTORS

Building a 90° corner on a Lafitt and Melville Tandem wall requires installing a wall end (described earlier), then juxtaposing a second wall perpendicular to it. Glue every course in the wall corner using Techniseal concrete adhesive.

Once again, for a natural look, avoid aligning vertical joints from one row to the next on all visible surfaces.

PLAN VIEW

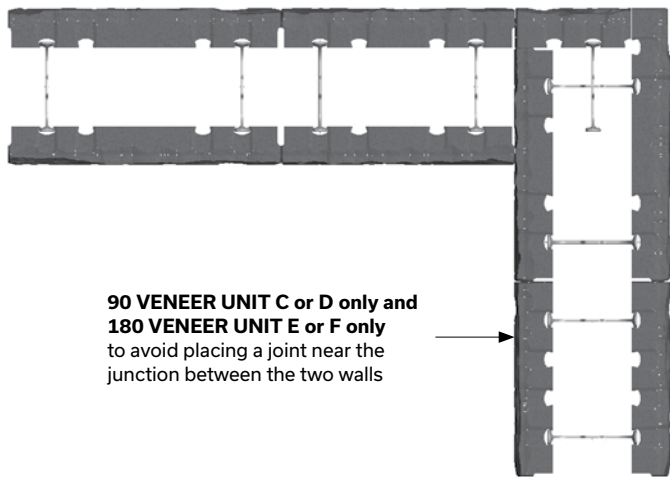

1<sup>st</sup> COURSE and all odd courses

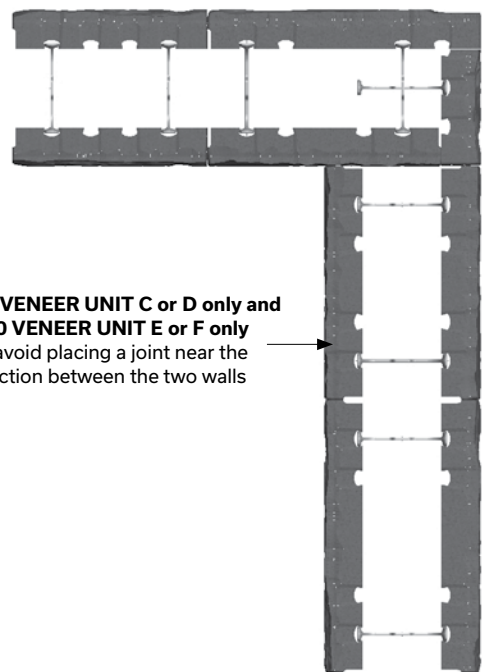

2<sup>nd</sup> COURSE and all even courses

## BUILDING A DOUBLE-SIDED WALL

### DOUBLE-SIDED WALL WITH 90° CORNERS (CONT'D)

#### 90° CORNER IN A DOUBLE-SIDED 90 mm AND 180 mm WALL

Building a 90° corner on a wall requires installing a wall end (described earlier), then juxtaposing a second wall perpendicular to it. The second wall can be built starting with double-sided Tandem 90 or 180 units. Adhere every course in the wall corner using Techniseal concrete adhesive.

Corners are built using the options available for that height (90 or 180). These options were illustrated and explained earlier in this document. The selection of corner unit heights and their positioning in the wall is a matter of aesthetics. The 90 and 180 units must be inserted in a similar proportion to the remainder of the wall so that they harmonize.

#### CAPPING A DOUBLE-SIDED WALL

Double-sided Tandem walls are completed using Melville Plus capping (60 mm x 305 mm x 600 mm) laid side by side. To cap a 90° corner, simply install two capping units at a 90° angle. For curved walls, capping units must be bevelled on site to match the final shape of the wall.

Options: Celtik wall system capping units and Melville capping units can also be used.

##### PLAN VIEW

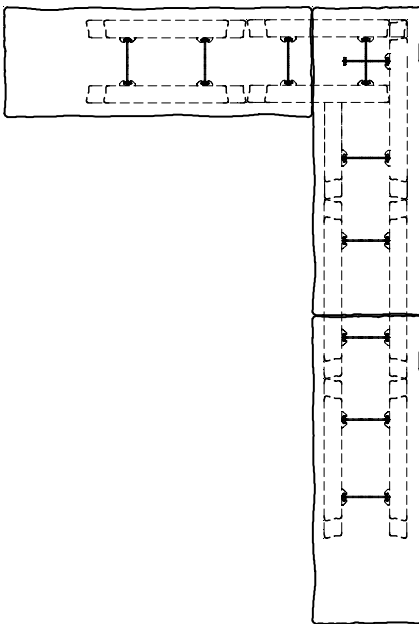

Note that all capping units must be attached to the last row of Tandem units using Techniseal concrete adhesive.

## BUILDING A DOUBLE-SIDED WALL

### DOUBLE-SIDED WALL WITH 90° CORNERS (CONT'D)

#### 90° CORNER IN A DOUBLE-SIDED 90 mm AND 180 mm WALL

Building a 90° corner on a wall requires installing a wall end (described earlier), then juxtaposing a second wall perpendicular to it. The second wall can be built starting with double-sided Tandem 90 or 180 units. Adhere every course in the wall corner using Techniseal concrete adhesive.

Corners are built using the options available for that height (90 or 180). These options were illustrated and explained earlier in this document. The selection of corner unit heights and their positioning in the wall is a matter of aesthetics. The 90 and 180 units must be inserted in a similar proportion to the remainder of the wall so that they harmonize.

#### CAPPING A DOUBLE-SIDED WALL

Double-sided Tandem walls are completed using Melville Plus capping (60 mm x 305 mm x 600 mm) laid side by side. To cap a 90° corner, simply install two capping units at a 90° angle. For curved walls, capping units must be bevelled on site to match the final shape of the wall.

Options: Celtik wall system capping units and Melville capping units can also be used.

##### PLAN VIEW

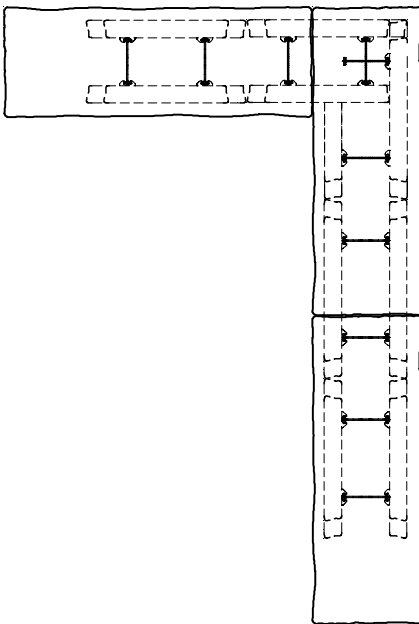

Note that all capping units must be attached to the last row of Tandem units using Techniseal concrete adhesive.

# Building Stairs



MELVILLE 60 STEPS

To build Melville Plus 60 stairs, we suggest using Melville Plus 60 units combined with Melville Tandem Plus 180 units used as risers, as shown here:

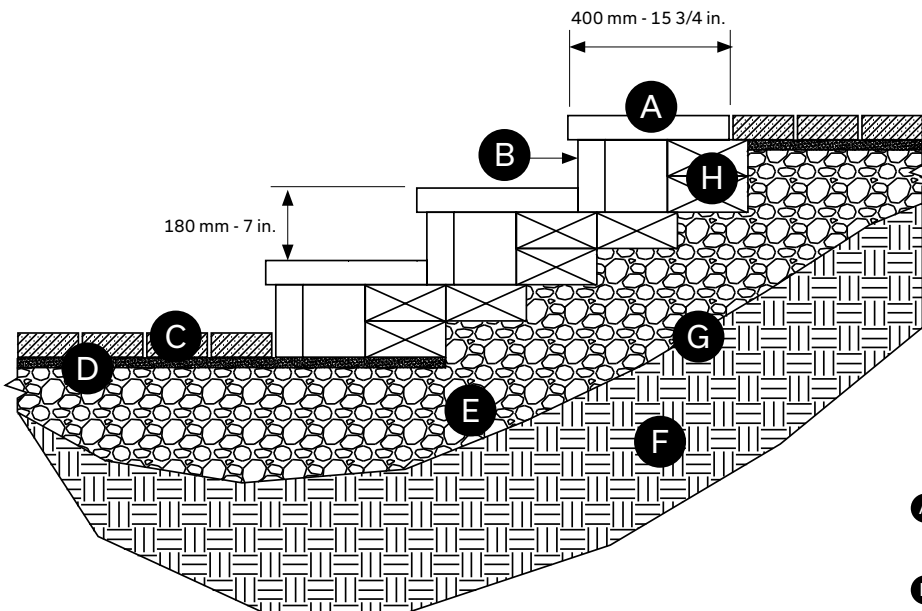

- A** Melville Plus 60 step  
60 x 400 x 600 mm - 2 3/8 x 15 3/4 x 23 5/8 in.
- B** Structural and veneer Melville Tandem 180 unit
- C** Concrete paver 60 mm - 2 3/8 in.
- D** Installation bed 25 mm - 1 in.
- E** 0 to 20 mm - 0 to 3/4 in. compacted granular foundation
- F** Existing soil
- G** Geotextile membrane
- H** Starter unit 90 x 268 x 469 mm - 3 1/2 x 10 1/2 x 18 1/2 in.

## MELVILLE TANDEM 60 STEP UNITS STAIR INTEGRATION / TANDEM WALL

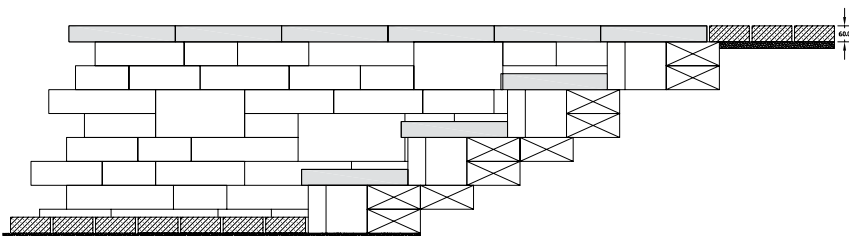

All step and riser units must be glued together using Techniseal concrete adhesive.



MELVILLE 90 STEPS

To build Melville Plus 90 stairs, we suggest using Melville Plus 90 units combined with Melville 90 units used as risers, as shown here:

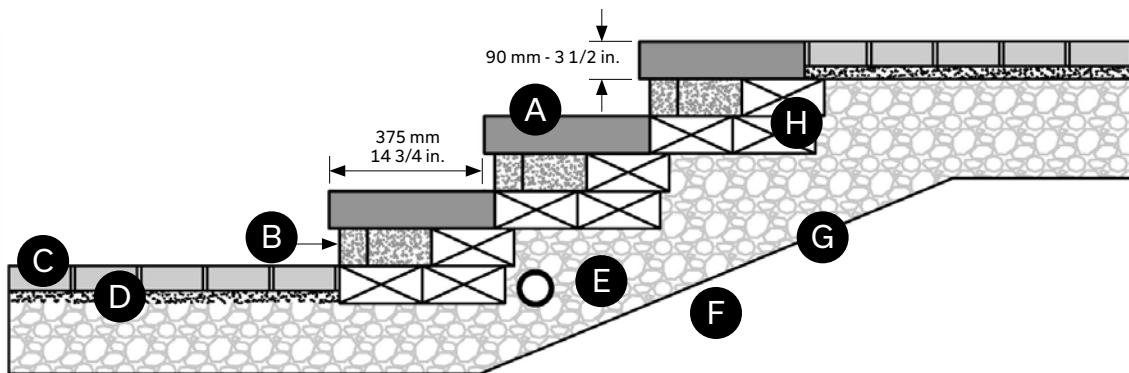

- A** Melville Plus 90 step  
60 x 400 x 600 mm - 2 3/8 x 15 3/4 x 23 5/8 in.
- B** Structural and veneer Melville Tandem  
90 unit
- C** Concrete paver 60 mm - 2 3/8 in.
- D** Installation bed 25 mm - 1 in.
- E** 0 to 20 mm - 0 to 3/4 in. compacted  
granular foundation
- F** Existing soil
- G** Geotextile membrane
- H** Starter unit 90 x 268 x 469 mm -  
3 1/2 x 10 1/2 x 18 1/2 in.

All step and riser units must be glued together using Techniseal concrete adhesive.

**LAFITT 90 STEPS**

To build Lafitt Tandem stairs, it is recommended that the step unit be used in combination with one of the following options for the riser:

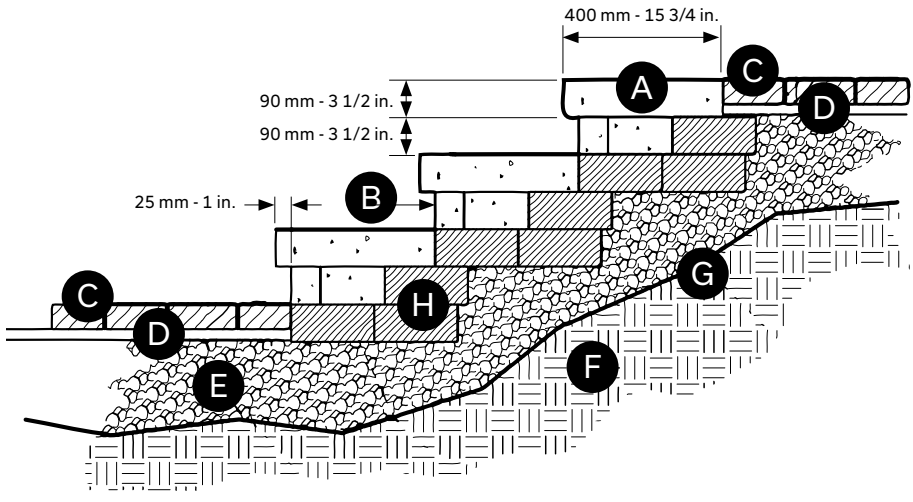

**OPTION 1**

Structural unit and Lafitt Tandem veneer  
 90 x 222 mm x variable - 3 9/16 x 8 3/4 x variable

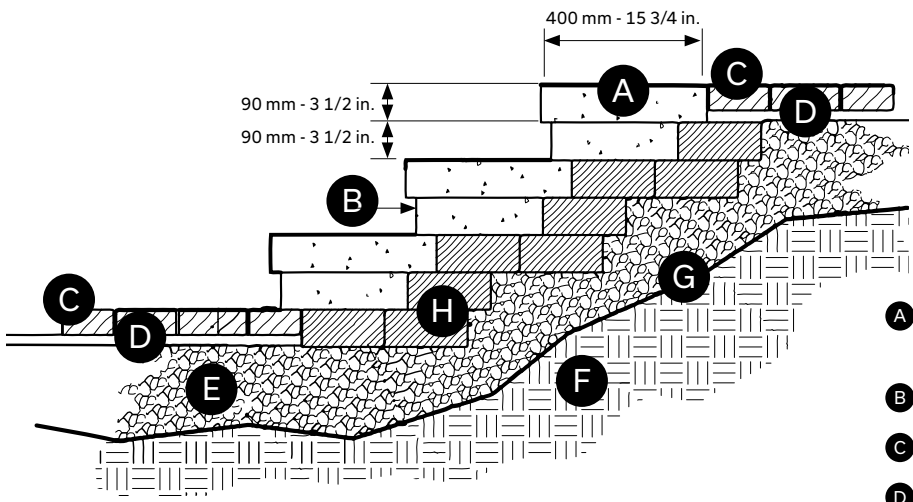

**OPTION 2**

Lafitt straight capping unit  
 90 x 305 x 400 mm - 3 1/2 x 12 x 15 3/4 in.

- A** Lafitt Plus 90 step unit  
 90 x 400 x 400 mm - 3 1/2 x 15 3/4 x 15 3/4 in.
- B** **OPTION 1** or **OPTION 2**
- C** Concrete paver 60 mm - 2 3/8 in.
- D** Installation bed 25 mm - 1 in.
- E** 0 to 20 mm - 0 to 3/4 in. compacted granular foundation
- F** Existing soil
- G** Geotextile membrane
- H** Starter unit 90 x 268 x 469 mm - 3 1/2 x 10 1/2 x 18 1/2 in.

All step and riser units must be glued together using Techniseal concrete adhesive.



# Building Pillars

## DIFFERENT TYPES OF TANDEM PILLARS



This section discusses the different types of pillars which can be built using the Tandem system, namely:

- > Tandem pillars with steel pillar grids
- > Tandem pillars with structural units

Tandem Veneer units are used for the exterior facing of the pillar. The interior core of the column serves a structural function and can be built in accordance with one of the following two methods: using structural units (regular Tandem system) or using a steel pillar grid instead of structural units (Tandem pillar grid).

## TANDEM PILLARS WITH PILLAR GRIDS

This type of pillar is built with Lafitt and Melville Tandem Veneer units only. The building of this type of column begins with the use of a steel pillar grid which provides structural support for the veneer units. The units are fastened to the pillar grid using specially-designed connectors.

The essential details for building this type of pillar are described below.

### 90 mm LAFITT AND MELVILLE TANDEM COLUMN WITH PILLAR GRID ASSEMBLY

With this material you can construct one pillar of 670 x 670 mm - 26 3/8 x 26 3/8 in. to a maximum height of 1080 mm - 42 1/2 in.

One pillar requires the use of 2.6 m<sup>2</sup> - 28 ft<sup>2</sup> of veneer units.

One cube contains 10 pillar grids and 10 bags of 200 grid connectors.

#### MATERIAL NEEDED:



GRID CONNECTORS  
Bag of 200 units

#### LAFITT or MELVILLE TANDEM veneer units:

- > 48 regular units  
(12a, 12b, 12c, 12d)
- > 48 textured end corner units  
(12a, 12b, 12c, 12d)

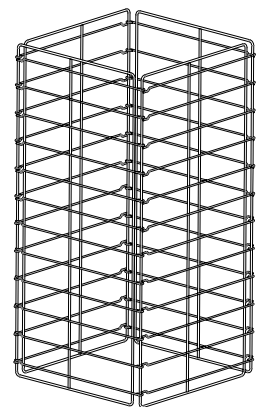

TANDEM PILLAR GRID

NOTE: All Melville veneer units come with one textured end (corner units)



**CROSS-SECTION - LAFITT OR MELVILLE TANDEM PILLAR GRID**

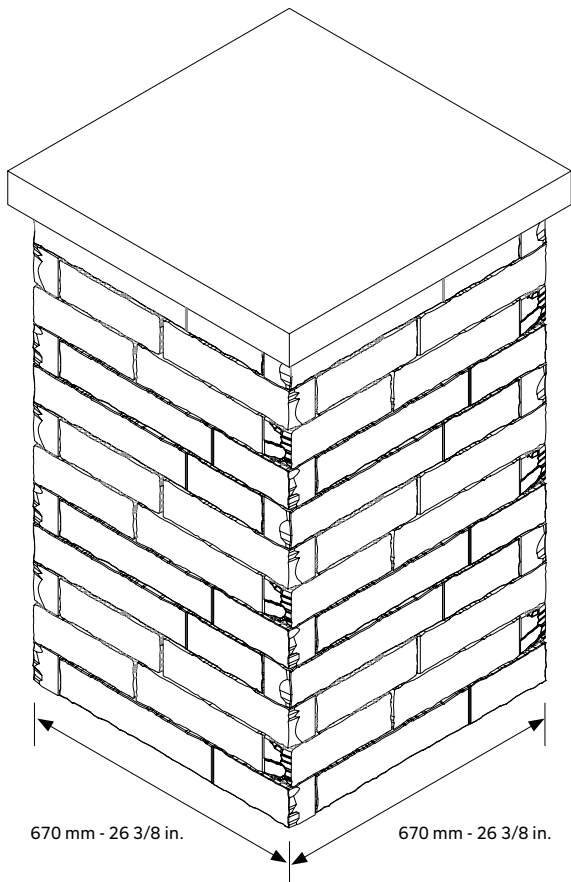
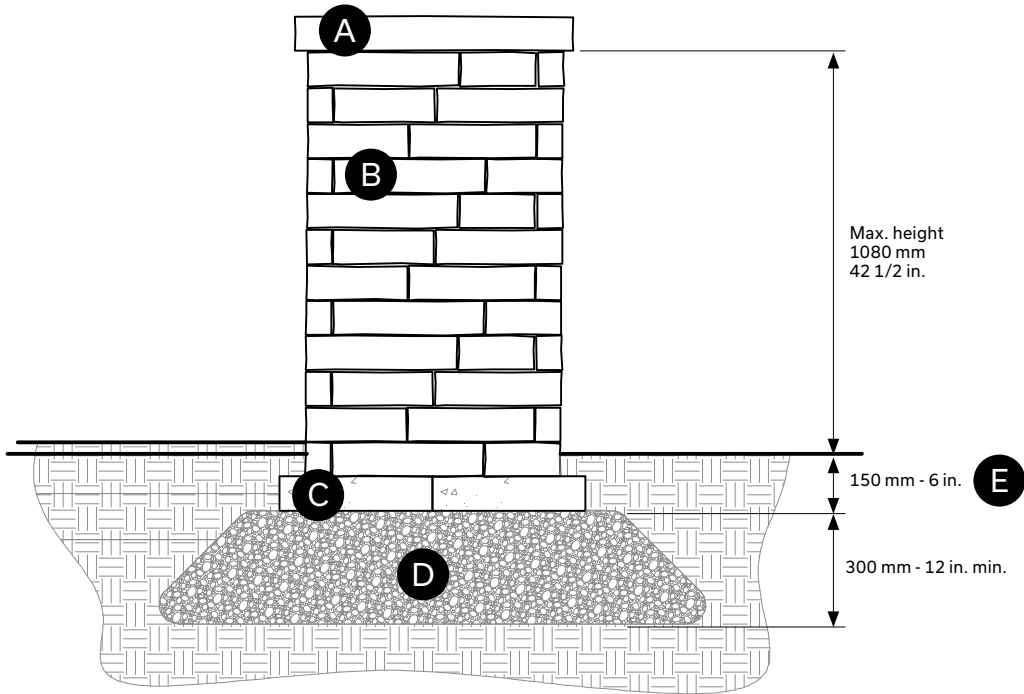

- A** Natural stone pillar capping unit 29 x 29 in.
- B** 90 mm Lafitt or Melville Tandem veneer unit
- C** Starter unit 90 x 268 x 469 mm - 3 1/2 x 10 1/2 x 18 1/2 in.
- D** 0 to 20 mm - 0 to 3/4 in. compacted granular foundation, 300 mm - 12 in. minimum
- E** Minimum buried depth 150 mm - 6 in.

## LAFITT OR MELVILLE TANDEM PILLAR ASSEMBLY

Begin by placing a row (8 units) of starter units on a base of compacted crushed stone. Unfold the steel pillar grid and place it on the prepared surface.

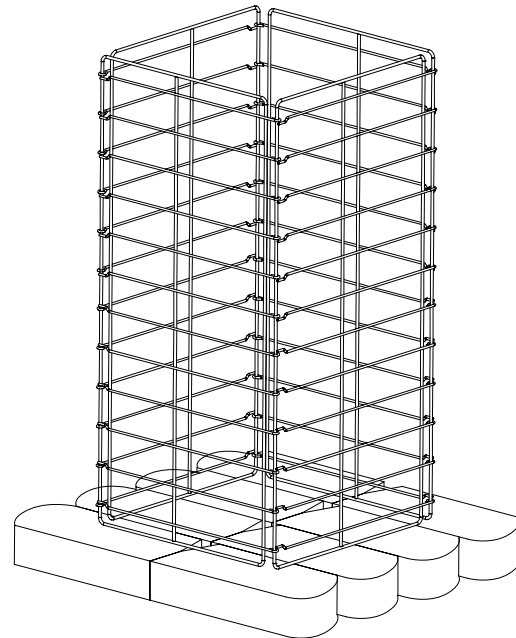
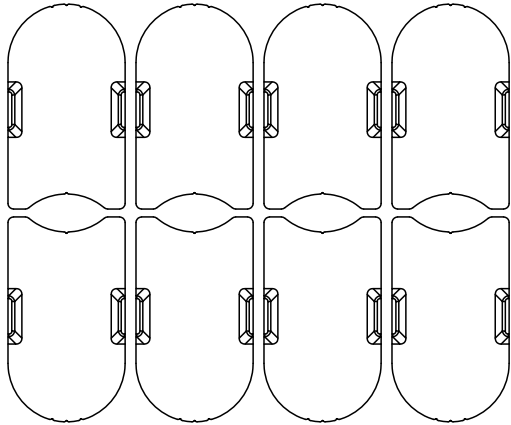

1st ROW OF STARTER UNITS

Insert the pillar connectors (using 2 connectors for each unit) into the veneer units which form the first row of the pillar. Place the veneer units for the first row around the steel pillar grid, making sure to "click" the connectors onto the horizontal wires (refer to the recommended installation pattern for the veneer units which have been selected).

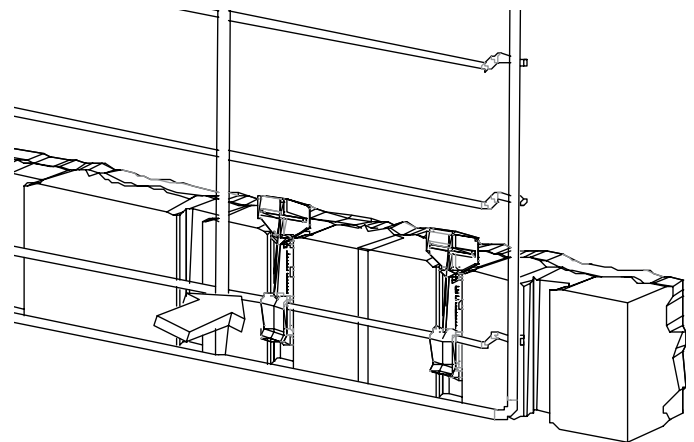
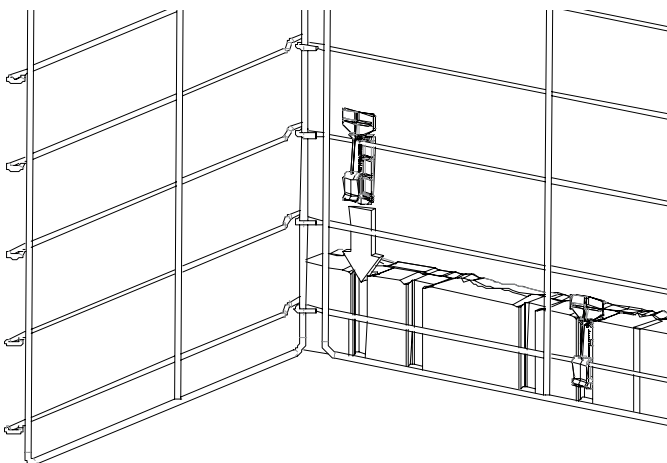

# BUILDING PILLARS

## LAFITT OR MELVILLE TANDEM PILLAR ASSEMBLY (CONT'D)

The corners of the pillar can be built easily by sliding the units along the wire until they line up with the corner unit which was installed previously.

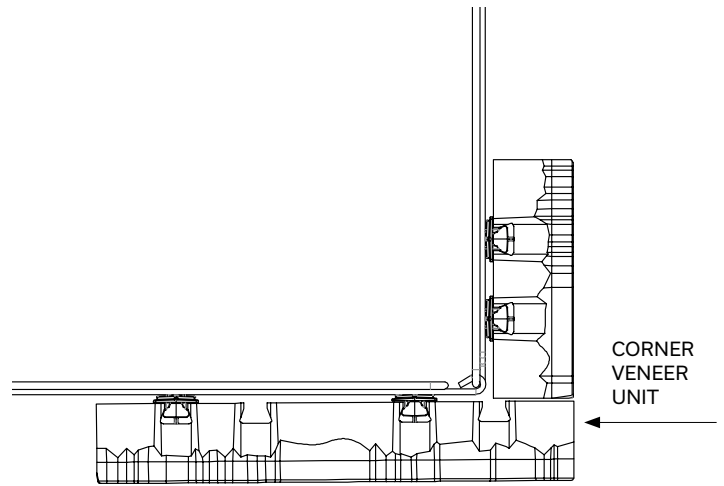
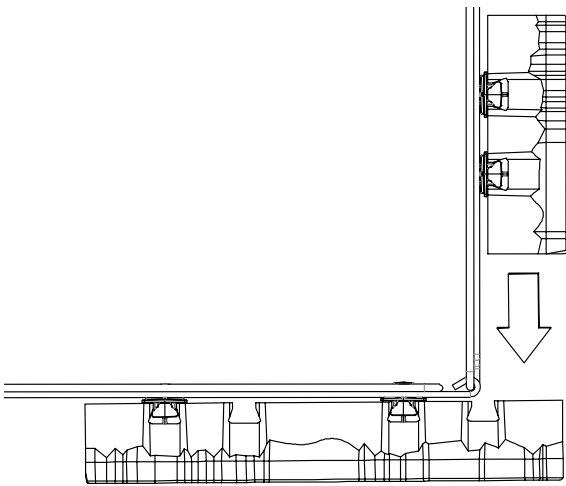
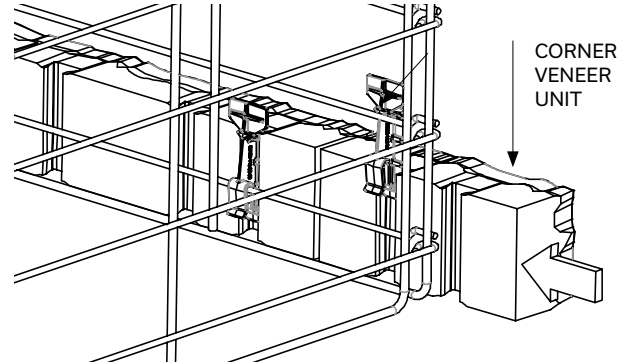
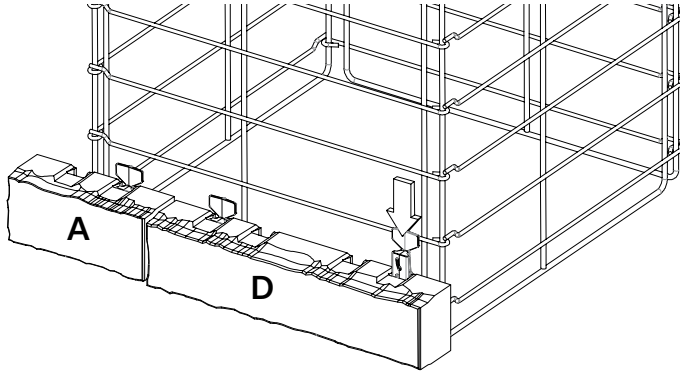

## LAYING PATTERNS

**TANDEM PILLAR WITH 90 mm UNITS**  
First 4 rows (over the starter units) 360 mm - 14 in.

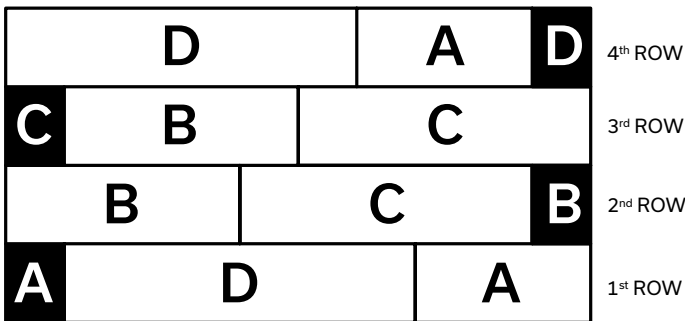

Installation pattern to repeat up to DESIRED HEIGHT

**90 mm TANDEM PILLAR WITH 180 mm UNITS**  
First 5 rows (over the starter units) - for reference only

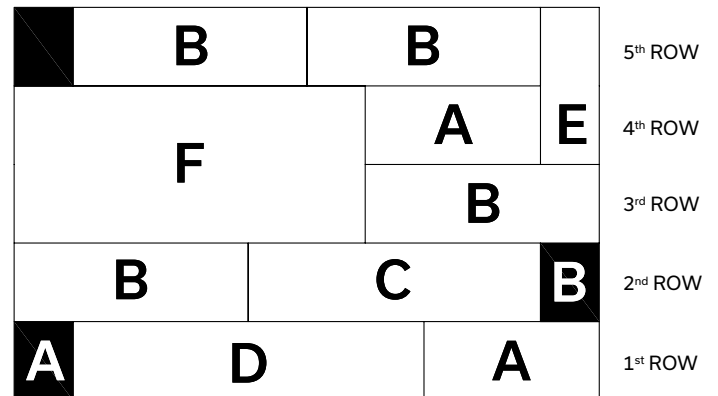

Installation pattern to repeat up to DESIRED HEIGHT

**LAFITT OR MELVILLE TANDEM 90 mm PILLAR ASSEMBLY**

Once the first row has been completed, fill the interior space with clean 20 mm aggregate, and then use a square to ensure that the corner units are perpendicular to each other. Repeat this step after every second row has been completed. Install subsequent rows in the same manner, up to the desired height.

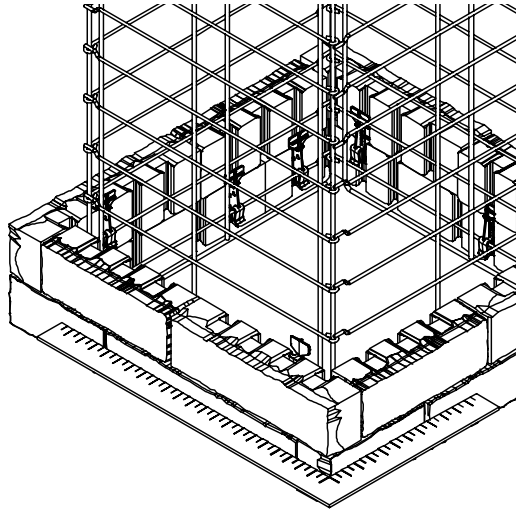

Ensure that the upper part of each connector is firmly in place behind the veneer unit, since it will serve as a support for the unit which will be installed above it.

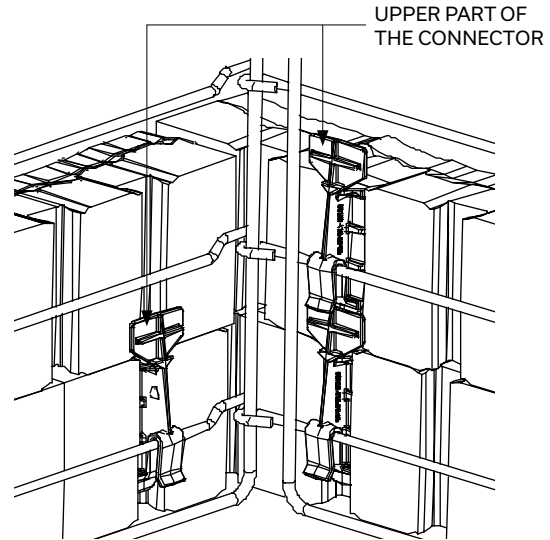

This is the recommended installation procedure for building the first four rows of a pillar. It makes optimal use of the veneer formats within a pallet: 16 regular veneers and 16 veneers with a texture end.

Repeating this pattern two more times will build a pillar with 12 rows and a height of 42 1/2 inches.

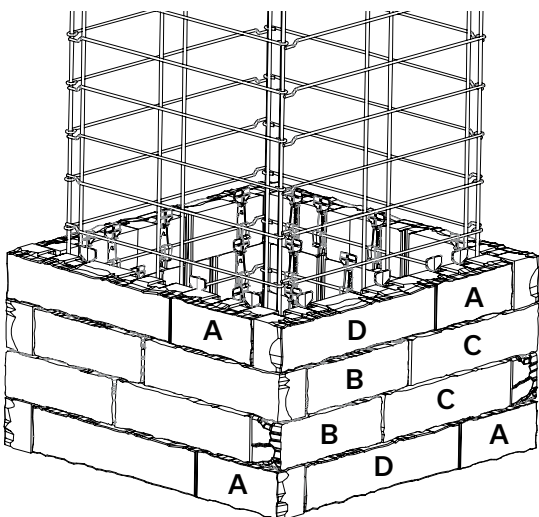

**CUTTING INSTRUCTION OF PILLAR GRID**

To build a pillar which is shorter than 1067 mm - 42 in., simply cut away the excess portion of the steel pillar grid with a grinder.

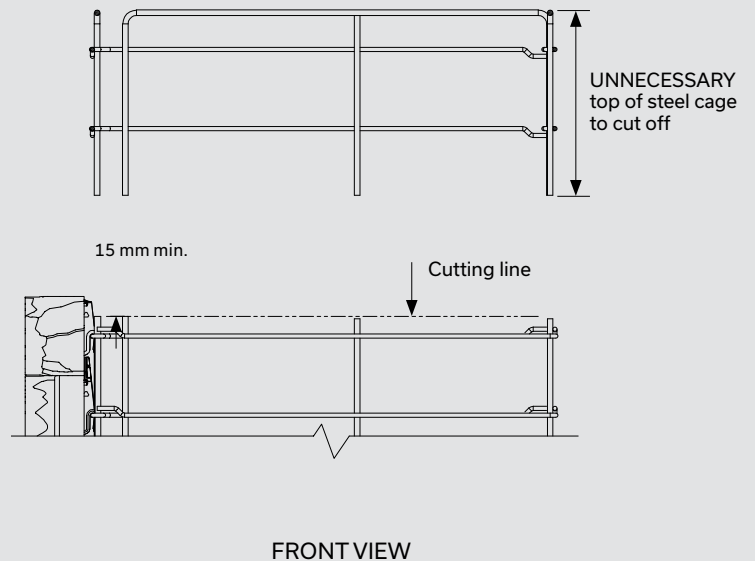

# BUILDING PILLARS

## LAFITT OR MELVILLE TANDEM 90 mm PILLAR ASSEMBLY (CONT'D)

A full steel pillar grid can be used to build a pillar with an overall height above ground, including the capping unit of 1067 mm - 42 in.

When the last row is reached, cut off the tops of the connectors with sheet-metal shears or twist them off by hand. Then install the capping unit on the pillar\*, adhering it in place with glue.

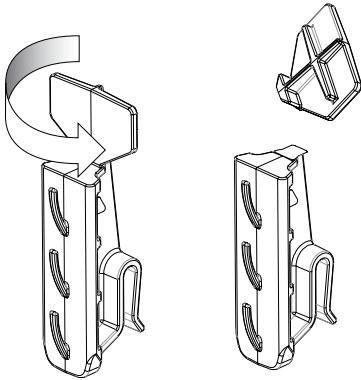
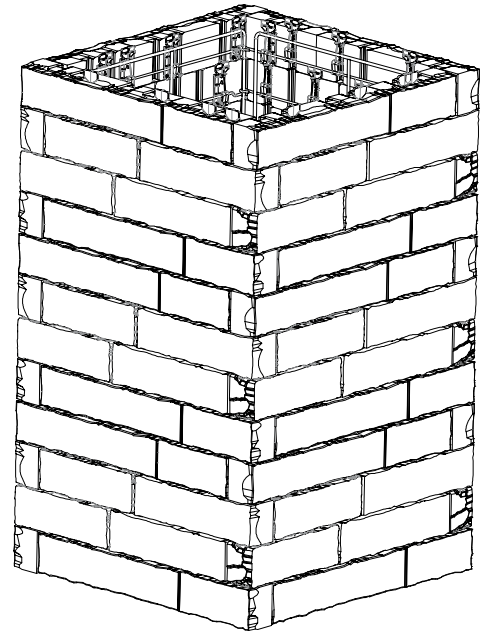

**\* VERY IMPORTANT:** the capping unit must rest on the veneer units and not on the steel pillar grid.

## LAFITT OR MELVILLE TANDEM PILLAR 90 mm AND 180 mm VENEER UNITS

When using 180 mm high veneer units, use four connectors as shown below, beginning with the two lower ones and ending with the two upper ones.

To integrate 180 mm units into a pillar, use only 180 mm E and F units with textured corners. Carefully place the veneer units so that the joints are staggered, and ensure that you place at least one 180 mm unit on each side of the pillar, and not more than two.

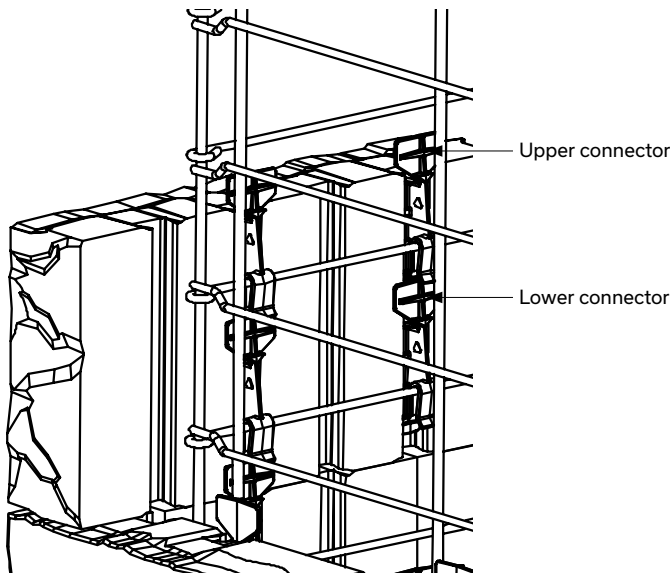

## JOINING A DOUBLE-SIDED WALL TO A PILLAR

To join a double-sided wall to a pillar, you must cut the veneer unit for the pillar at every second row. Cut it at the centre of the dovetail recess.

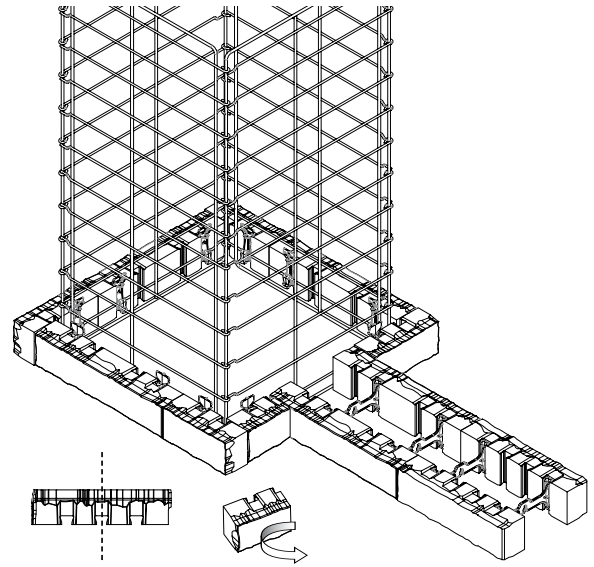

For the second row, run the unit across the double-sided wall.

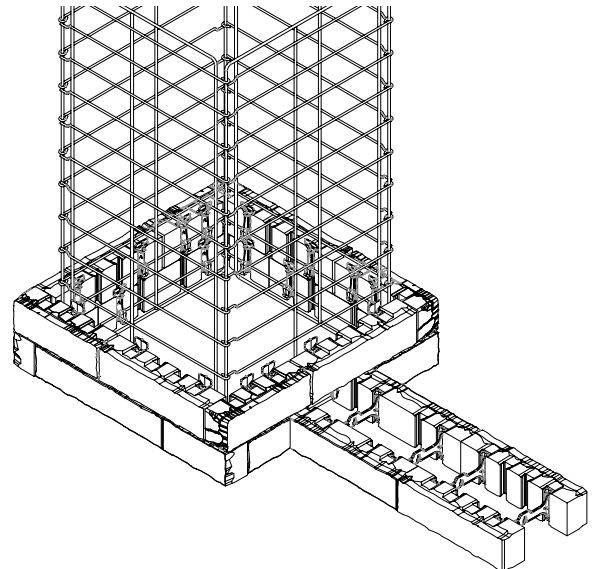

Begin the second row of the double-sided wall from the face of the pillar.

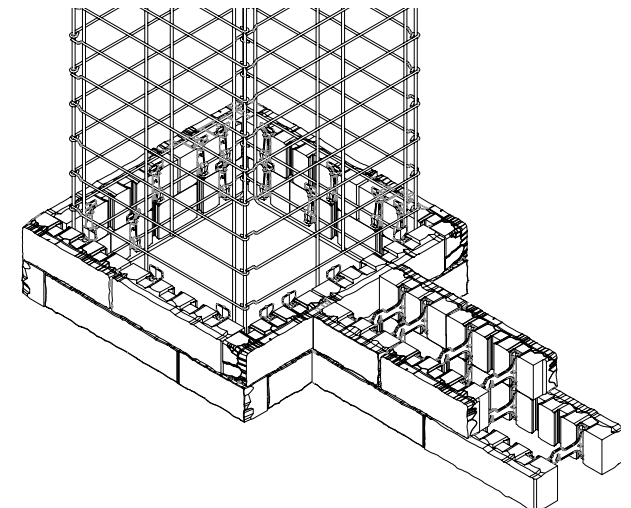

# BUILDING PILLARS

## LAFITT AND MELVILLE TANDEM PILLAR WITH STRUCTURAL UNITS

Two types of pillars can be built:

- > Lafitt Tandem
- > Melville Tandem

Pillars are built by placing Tandem units at 90° angles to create a square. Corners can then be completed by adding the appropriate textured veneer units. These veneers are attached using a corner connector as mentioned in the section on building a corner. It is advisable to glue each unit together for every course.

Maximum pillar height ranges from 1200 to 1500 mm - 4 to 5 ft. above ground level with a minimum buried depth of 150 mm - 6 ft. Capping is completed using a natural stone glue on last row. See table.

The predetermined installation patterns which are provided are intended to facilitate the building of each type of pillar. They also permit the optimal use of the different Tandem units and the textured veneer units.

In all cases, it is important to avoid aligning vertical joints from one row to the next on all visible facades. For these reasons, some combinations should be avoided from row to another.

Note that for some combinations, you need to use a structural unit A cut in two and fitted together with the veneer units.

When a double-sided wall ends at a pillar, the pillar must be modified to ensure it is solidly embedded, as in the illustration shown here.

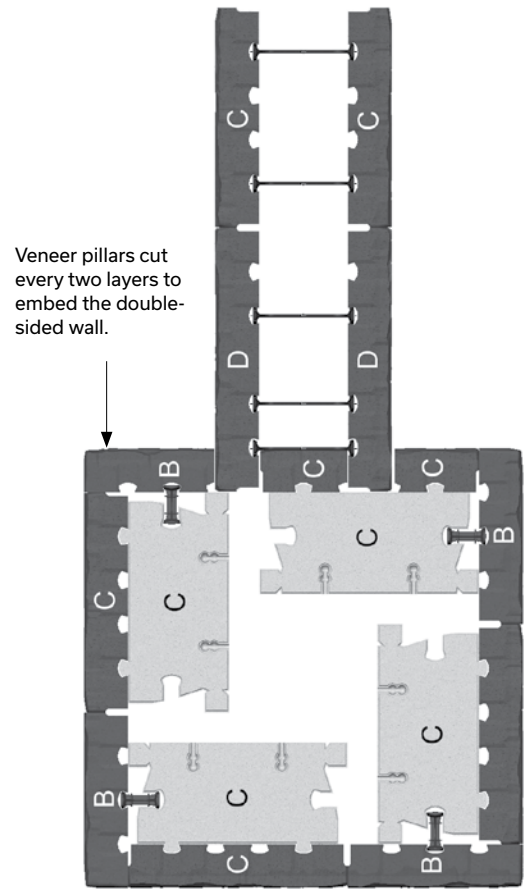

EXAMPLE OF EMBEDDING

90 PILLAR UNIT	MAXIMUM HEIGHT
670 x 670 mm 26 3/8 x 26 3/8 in.	1200 mm - 4 ft
737 x 737 mm 29 x 29 in.	1500 mm - 5 ft



# BUILDING PILLARS

## LAFITT AND MELVILLE TANDEM PILLAR WITH 90 mm UNITS

### PILLAR

670 x 670 mm - 26 3/8 x 26 3/8 in.

1<sup>st</sup> ROW

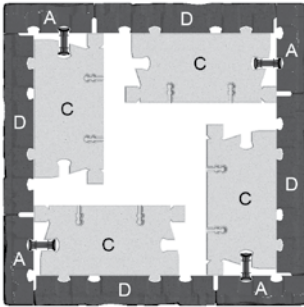

Veneer A with textured end

2<sup>nd</sup> ROW

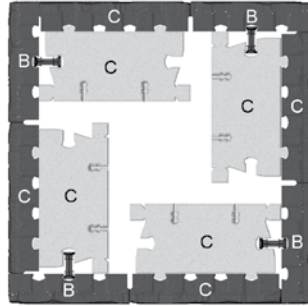

Veneer B with textured end

3<sup>rd</sup> ROW

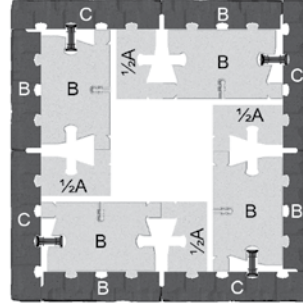

Veneer C with textured end

4<sup>th</sup> ROW

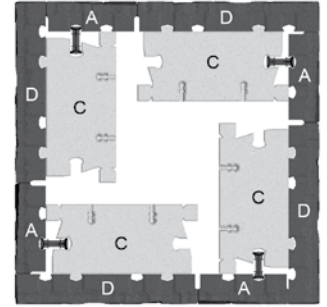

Veneer D with textured end

# BUILDING PILLARS

## LAFITT AND MELVILLE TANDEM PILLAR WITH 90 mm UNITS (CONT'D)

### PILLAR

737 x 737 mm - 29 x 29 in.

1<sup>st</sup> ROW

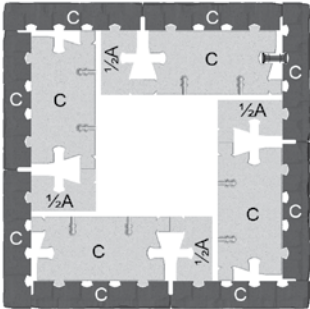

Veneer C with textured end

2<sup>nd</sup> ROW

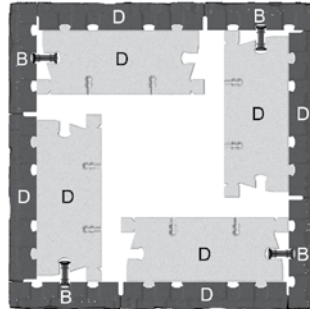

Veneer B with textured end

3<sup>rd</sup> ROW

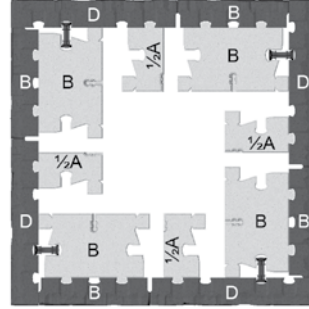

Veneer D with textured end

4<sup>th</sup> ROW

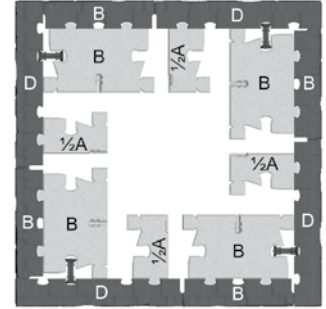

Veneer D with textured end

5<sup>th</sup> ROW

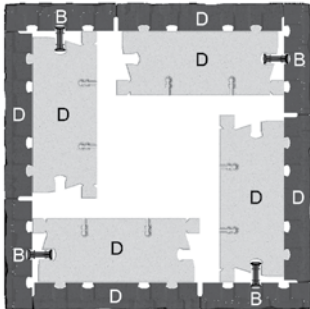

Veneer B with textured end

6<sup>th</sup> ROW

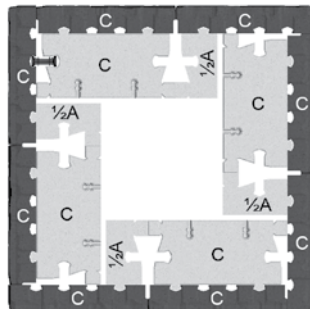

Veneer C with textured end

7<sup>th</sup> ROW

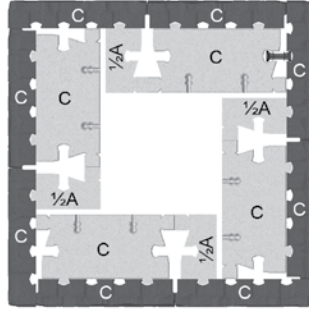

Veneer C with textured end

8<sup>th</sup> ROW

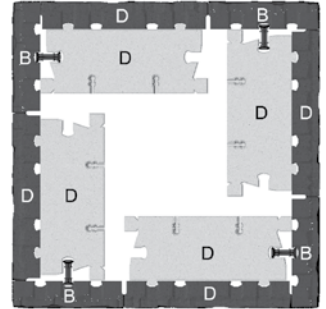

Veneer B with textured end

9<sup>th</sup> ROW

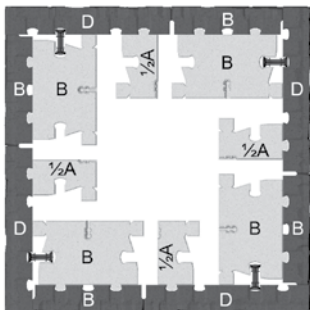

Veneer D with textured end

### LAYING PATTERN

TANDEM 90 mm PILLAR  
First 9 rows (over starter units)  
810 mm - 31 7/8 in.

#### LEGEND

- D** Veneer D with textured end
- C** Veneer C with textured end
- B** Veneer B with textured end
- A** Veneer A with textured end

Installation pattern to repeat up to  
DESIRED HEIGHT

<b>D</b>	<b>B</b>	<b>D</b>		9 <sup>th</sup> ROW
	<b>B</b>	<b>D</b>	<b>B</b>	8 <sup>th</sup> ROW
<b>C</b>	<b>C</b>	<b>C</b>		7 <sup>th</sup> ROW
	<b>C</b>	<b>C</b>	<b>C</b>	6 <sup>th</sup> ROW
<b>B</b>	<b>D</b>	<b>B</b>		5 <sup>th</sup> ROW
	<b>D</b>	<b>B</b>	<b>D</b>	4 <sup>th</sup> ROW
<b>D</b>	<b>B</b>	<b>D</b>		3 <sup>rd</sup> ROW
	<b>B</b>	<b>D</b>	<b>B</b>	2 <sup>nd</sup> ROW
<b>C</b>	<b>C</b>	<b>C</b>		1 <sup>st</sup> ROW

# Outdoor Living Components

## CONSTRUCTION OF OUTDOOR LIVING COMPONENTS WITH THE TANDEM MODULAR GRID (GENERALITY)



The Tandem system allows you to install different outdoor living components such as outdoor kitchens (barbecue, fridge, bar), patio furniture (bench and table), flower box, outdoor gas fireplace, privacy wall, fencing and deck skirting.

Indeed, you can easily build all these features by using the Tandem modular grid.

Our system has multiple benefits:

- > Provides a unified look for all the features of the landscaping design
- > Provides a durable, economical and maintenance-free solution
- > Offers great flexibility and unrestricted creativity regarding the configuration and size of components to be constructed
- > Offers a solution to difficult issues (e.g. deck skirting)
- > Eliminates the use of cementitious products (mortar)

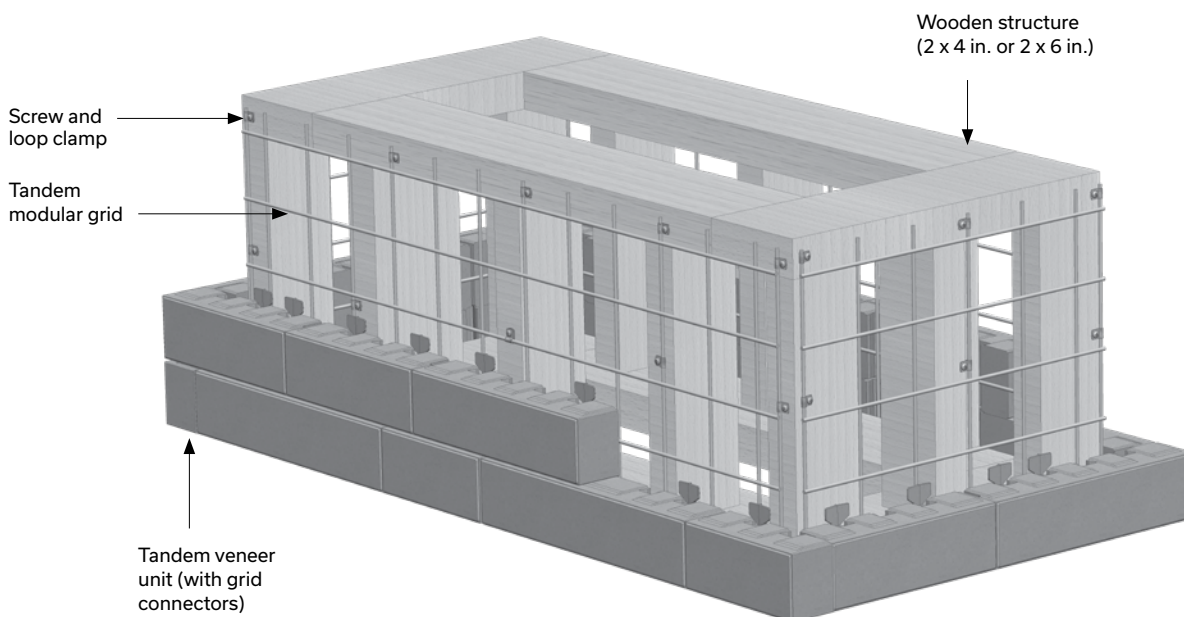

## BASIC PRINCIPLES

A set of Tandem modular grids is attached to a structure of treated wood to which are attached Tandem veneer units (Lafitt or Melville). Since veneer units are manufactured in multiples of 67 mm, the overall dimensions of outdoor units should always be a multiple of 67 mm in order to avoid cuts. The wooden structure should be built taking into account the modular design of Tandem veneers. The same applies to the height, which must be a multiple of 90 mm. The item is finished off with an appropriate capping unit. You can construct a range of outdoor units of various dimensions.

### MAIN COMPONENTS OF THE SYSTEM

- > Tandem modular grid, 720 x 1080 mm - 28 x 42 1/2 in., including stainless steel screws and loop clamps for fastening. A modular grid covers a facing surface of 0.78 m<sup>2</sup> - 8.40 sq.ft.). Each modular grid includes a kit of 60 connectors, 10 x 1 1/4 in. screws and 10 loop clamps.
- > Tandem veneer units (Lafitt or Melville)
- > Galvanized shelf angle (for deck skirting, privacy walls and fences) 64 x 64 x 2439 mm - 2 1/2 x 2 1/2 x 8 ft. (min 10 gauge, Z275 G90 galvanized steel, ASTM A653 Grade 33)
- > Permacon concrete capping unit (Lafitt, Melville et Mondrian Plus along with Celtik capping)

### OTHER COMPONENTS NOT SUPPLIED BY PERMACON

- > Treated Wood: 2 x 4, 2 x 6 and 2 x 8 boards, 4 x 4 or 6 x 6 posts, 4 x 8 plywood sheets (all wood should be treated against rot and must be category S-P-F #1 or better). Refer to the various suppliers' specific application sheets for details.
- > Fiber cement panels 1220 x 2240 x 12 mm (48 x 96 x 1/2 in.)
- > # 10 screws of varying lengths, nuts, bolts and washers where required, all in stainless steel. It is not recommended to use treated wood screws (green ceramic) or metal plated screws (zinc, copper or other)
- > Hilti Kwik Bolt-type anchors (for concrete deck skirting)
- > Simpson Strong-Tie-type hardware for construction of wood frame for deck
- > Custom countertops made of granite, quartz, marble and natural stone as alternatives to concrete tops

# CONSTRUCTION OF OUTDOOR LIVING COMPONENTS WITH THE TANDEM MODULAR GRID

## WOOD FRAMING

You must always take the modular design of Tandem Veneers into account when constructing wood framing. The overall dimensions of outdoor units must always be a multiple of 67 mm in length and width and 90 mm in height. When installing the framing, remember that grids need a 16 mm - 3/8 in. space between the veneer and the frame.

Bearing this in mind, the following tables show detailed measurements for the framing of units. These tables are very useful for quickly calculating the actual dimensions of the wood framing and the unit to be constructed to build the component without any veneers cut.

**TABLE OF COMPONENTS AND WOOD FRAME DIMENSIONS  
BASED ON THE MODULAR FORMAT OF VENEERS**

DIM A (mm)	DIM A (in.)	DIM B (mm)	DIM B (in.)
201	7 15/16	35	1 3/8
268	10 9/16	102	4
335	13 3/16	169	6 5/8
402	15 13/16	236	9 5/16
469	18 7/16	303	11 15/16
536	21 1/8	370	14 9/16
603	23 3/4	437	17 3/16
670	26 3/8	504	19 13/16
737	29	571	22 1/2
804	31 5/8	638	25 1/8
871	34 5/16	705	27 3/4
938	36 15/16	772	30 3/8
1005	39 9/16	839	33 1/16
1072	42 3/16	906	35 11/16
1139	44 13/16	973	38 1/4
1206	47 1/2	1040	40 15/16
1273	50 1/8	1107	43 9/16
1340	52 3/4	1174	46 1/4
1407	55 3/8	1241	48 7/8
1474	58 1/16	1308	51 1/2
1541	60 11/16	1375	54 1/8
1608	63 5/16	1442	56 3/4
1675	65 15/16	1509	59 3/8
1742	68 9/16	1576	62 1/16
1809	71 1/4	1643	64 5/8
1876	73 7/8	1710	67 5/16
1943	76 1/2	1777	69 15/16
2010	79 1/8	1844	72 5/8
2077	81 3/4	1911	75 1/4
2144	84 7/16	1978	77 7/8
2211	87 1/16	2045	80 1/2
2278	89 11/16	2112	83 1/8
2345	92 5/16	2179	85 3/4
2412	94 15/16	2246	88 7/16
2479	97 5/8	2313	91 1/16
2546	100 1/4	2380	93 11/16
2613	102 7/8	2447	96 5/16
2680	105 1/2	2514	99

**TANDEM VENEERS - MODULAR DESIGN**

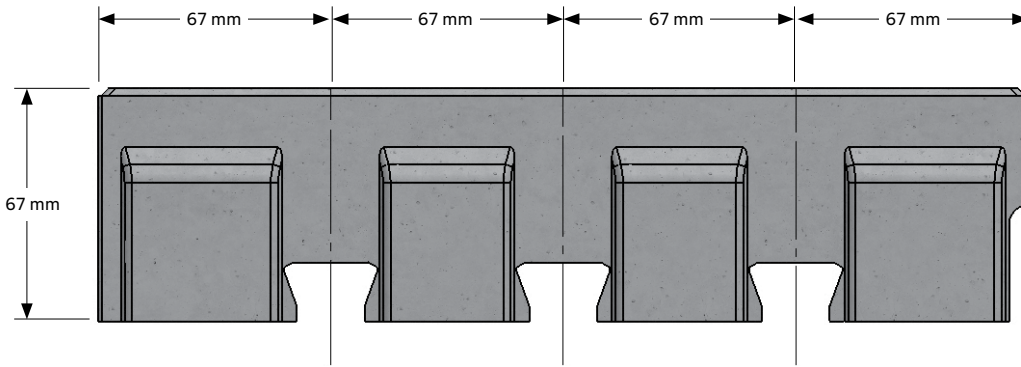

**TYPICAL COMPONENT - PLAN VIEW**

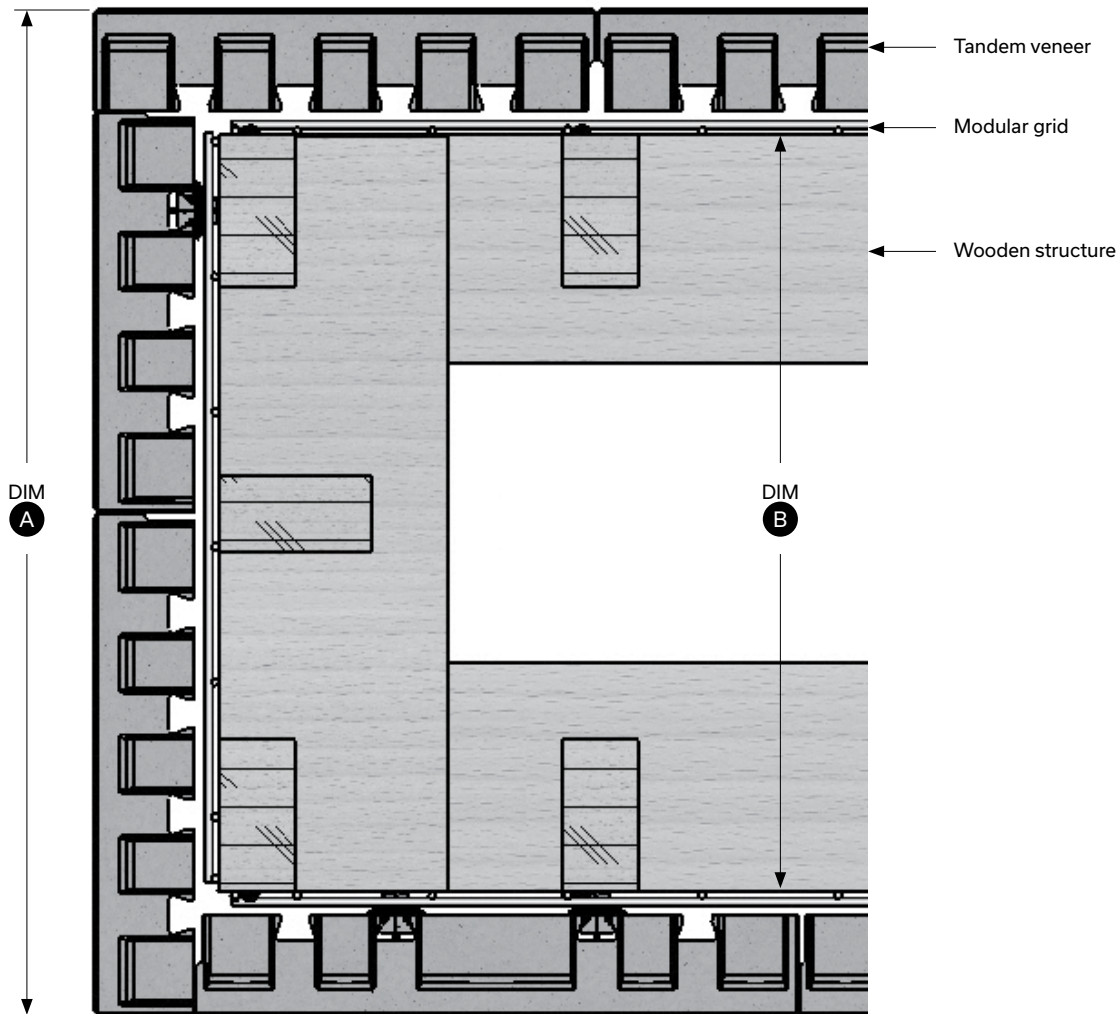



**TYPICAL COMPONENT - SIDE VIEW**

**HEIGHT OF COMPONENTS AND WOOD FRAME  
ACCORDING TO THE MODULAR DESIGN  
OF 90 mm VENEER UNITS**

NUMBER OF ROWS	HEIGHT (mm)	HEIGHT (in.)
2	180 mm	7 1/16
3	270 mm	10 5/8
4	360 mm	14 3/16
5	450 mm	17 11/16
6	540 mm	21 1/4
7	630 mm	24 13/16
8	720 mm	28 1/3
9	810 mm	31 1/8
10	900 mm	34 5/8
11	990 mm	39
12	1080 mm	42 1/2

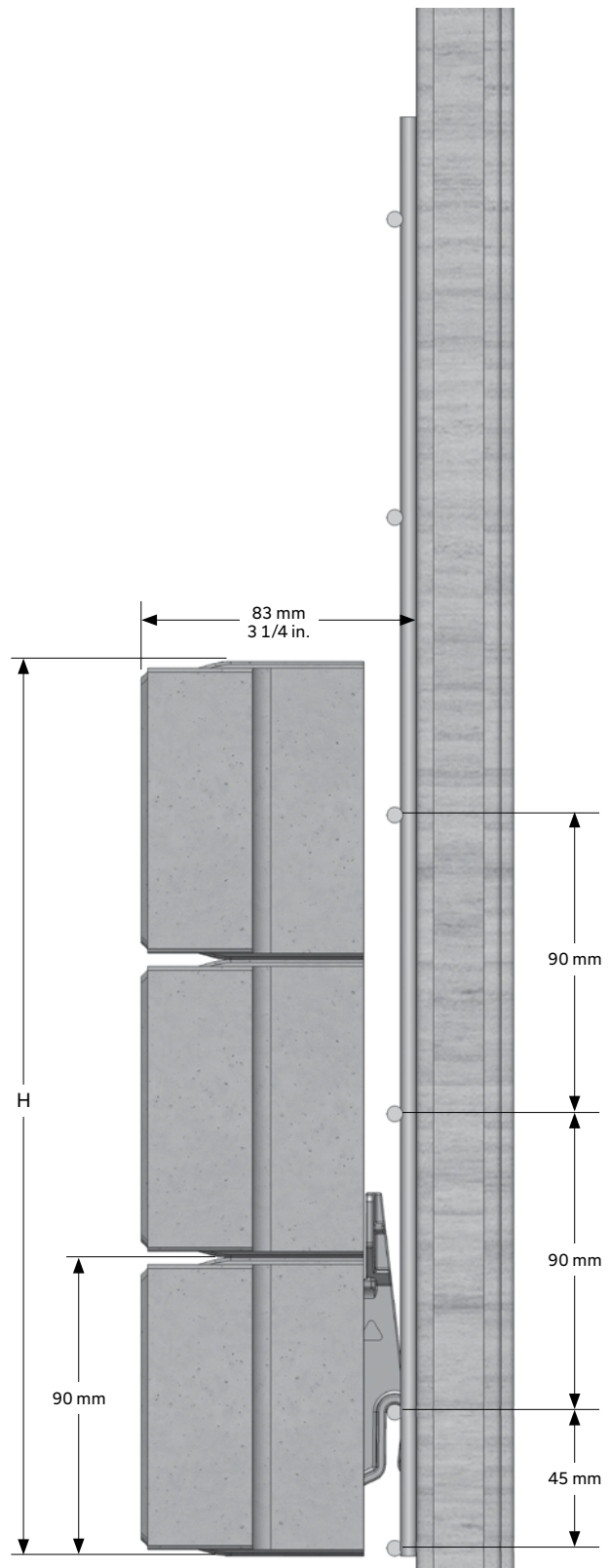



**TYPICAL COMPONENT - FRONT VIEW**

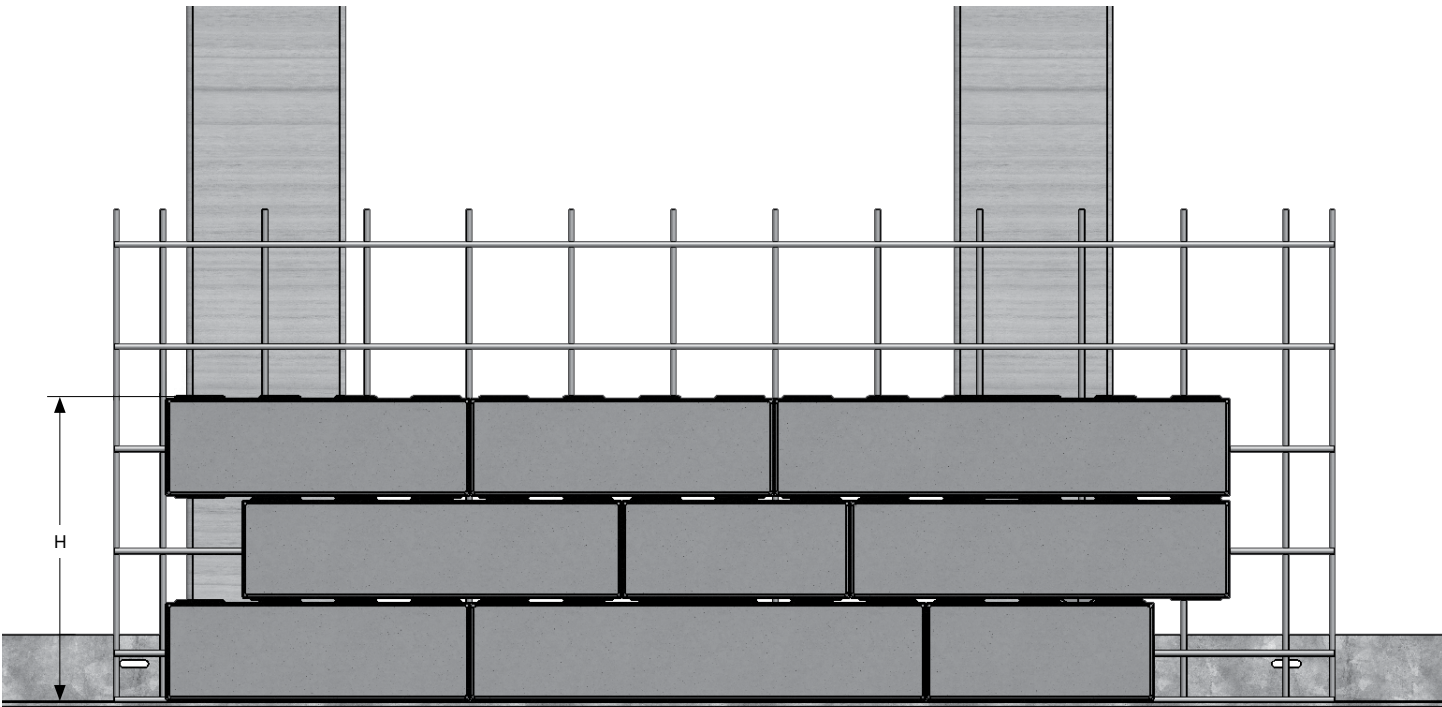

**TANDEM MODULAR GRID - DETAIL 1**

It is important to note that the units to be constructed must always be straight and have corners (inner and outer) forming a 90° angle. Therefore, making a corner is a common element in all construction plans. You can also refer to the plan view detail (page 44) to see how to make a 90° corner, taking into account the modular design of Tandem veneers and grids. When building the wood frame, keep in mind that you have to install Tandem grids. The flexibility of the grid means that you can install it in either direction, horizontally or vertically.

You have to cut the grids when the unit you're building is smaller in size (height or length) than a complete grid of 28 in. or 42 1/2 in. It may be helpful to decide the direction of the grid so as to minimize cuts. To cut a grid, use any suitable tool like a grinder or bolt cutters.

To avoid making cuts in the veneers, simply follow the dimensions based on the modular design of the veneers shown in the previous tables.

DETAIL 1

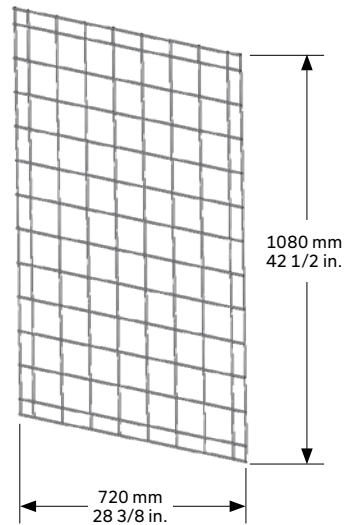

VERTICAL INSTALLATION

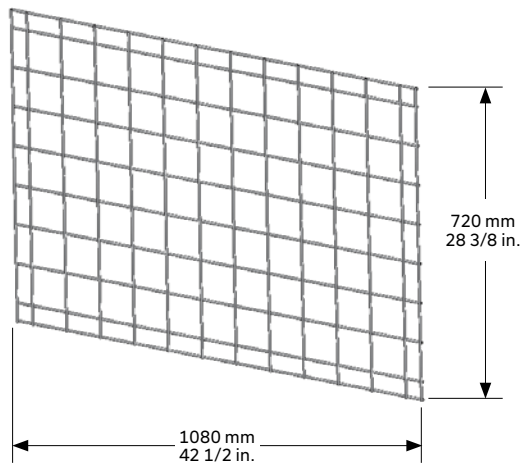

HORIZONTAL INSTALLATION

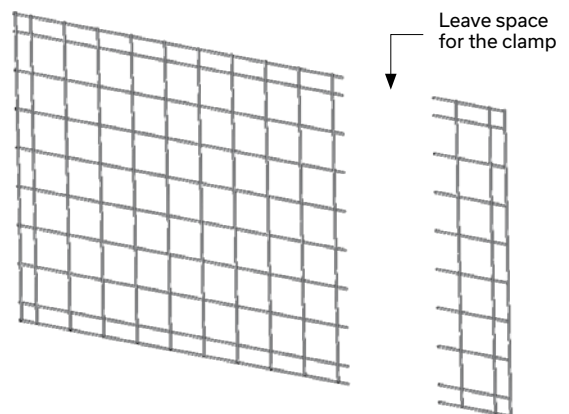

## TANDEM MODULAR GRID - DETAIL 2

The grid is attached with the loop clamps and screws supplied. Simply place the loop clamps around the vertical rods of the grid and then insert a screw into the wood frame. There are 10 loop clamps per Tandem grid.

To secure a grid, the loop clamps should be evenly positioned, starting with the edge of the grid and moving towards the center. To ensure the solidity of the grid, use approximately one fastener (screw and loop clamps) per square foot of grid or 10 fasteners per square meter. To attach a grid to the wood frame, the vertical rods must be placed directly against the structure.

Since the metal rods of the grids are spaced every 90 mm, it's helpful if the intermediate posts of the wood framing are multiples of 90 mm. This will increase the available attachment area for the grid. A continuous attachment area like plywood sheeting can also be used to provide a larger surface for attaching the Tandem grid.

When a unit requires more than one grid either horizontally or vertically, they should be installed one after the other in both directions.

### DETAIL 2

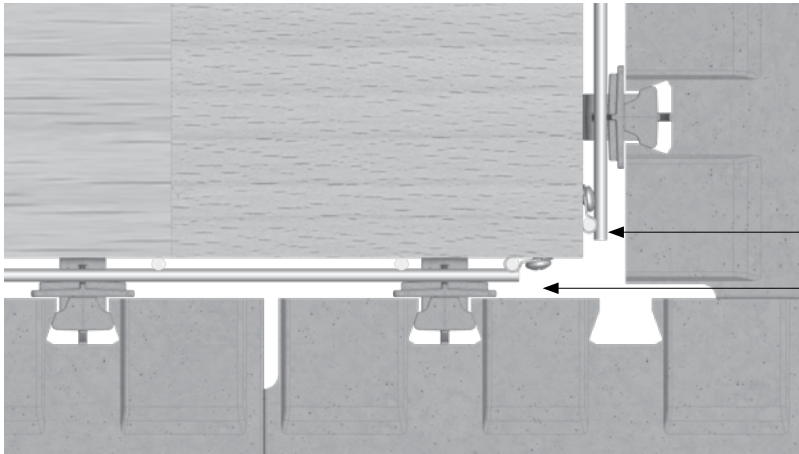

Keep the last vertical rod intact for better fixation  
Leave free space to attach the loop clamps

MODULAR GRID CUTTING INSTRUCTIONS (PLAN VIEW)



ISOMETRIC VIEW

**TANDEM VENEERS**

When the grids have been installed, just insert the veneers into the unit using the connectors specially designed for this purpose. We recommend using 2 connectors per veneer for a solid job, but sometimes a connector cannot be inserted due to the geometry of the grid. You must then secure the veneer by gluing it to surrounding veneers with Techniseal concrete adhesive.

Normally, for a standard project, all formats of the veneer units are used randomly. As for retaining walls, always keep in mind the principle of staggering the vertical joints from one row to another. For the corners, you need corner units just like constructing a pillar with steel grids (see BUILDING PILLARS section). But it should be noted that sometimes the construction of a short unit requires a larger quantity of the same format veneers, especially corner units (for Lafitt Tandem, the amount of veneer corner units is in a proportion of about 1/2 of a pallet. For Melville Tandem, all veneer units have a textured corner. It is important to check this when calculating the quantity so as to have enough of the appropriate veneers on hand.

It is also possible to use 180 mm veneers when constructing a unit, the same as for a retaining wall or a column.

Stacking position on pallets (with a textured end)

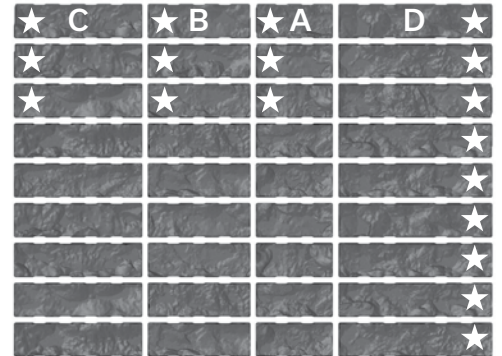

LAFITT TANDEM - UNITS 90

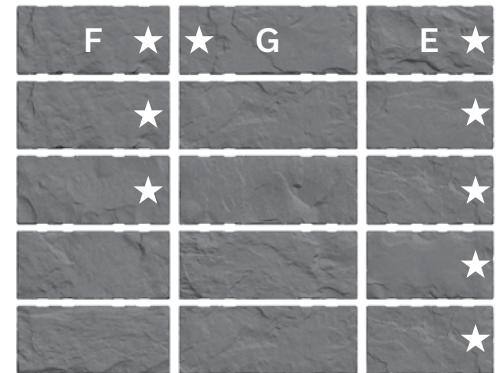

LAFITT TANDEM - UNITS 180

## BRACING

Some items require bracing panels like plywood sheeting, especially for privacy walls, fencing and deck skirting. These panels are needed to strengthen the unit to withstand stress such as wind and to limit distortion under regular loads.

EXAMPLE OF BRACING (privacy wall)

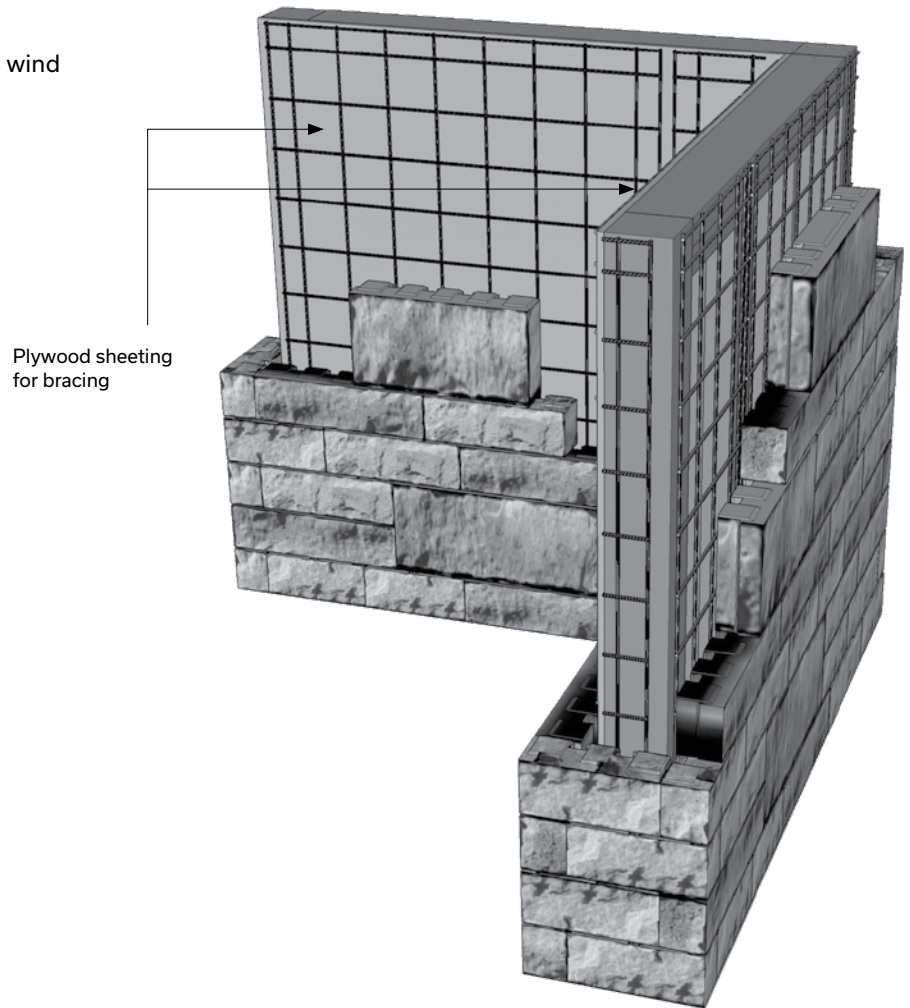

Other units require the installation of fiber cement panels for heat insulation (barbecues and outdoor gas fireplaces) or as protection against moisture (flower boxes). In these situations, we recommend fiber cement panels of a minimum thickness of 12 mm - 1/2 in.

EXAMPLE OF A HEAT PROTECTION SET-UP

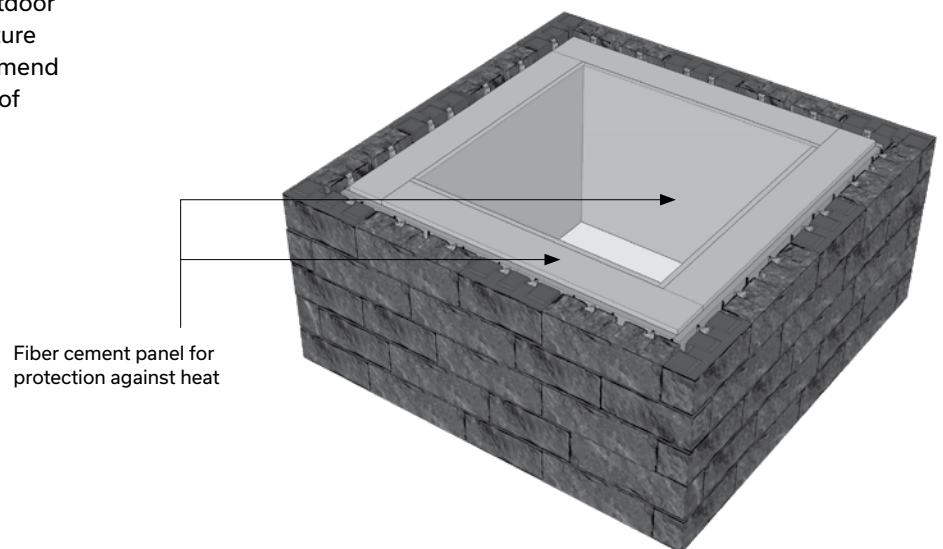



## BASE SUPPORT FOR OUTDOOR UNITS

Outdoor units like a bench, flower box or outdoor fireplace can usually be built on a base of concrete foundation (starter units) or placed directly onto concrete pavers. A granular base of compacted crushed stone should be laid before the foundation. However, we recommend that long or heavy units be supported on a concrete slab (minimum thickness of 150 mm or 6 in. We also recommend that units like barbecues or tables with a single granite, quartz or marble top over their entire surface be supported on a reinforced concrete slab to prevent the top from breaking if the ground shifts. In each case, a compacted granular base should underlie the concrete slab.

### CROSS SECTION - COMPONENTS SUPPORTED ON A CONCRETE SLAB

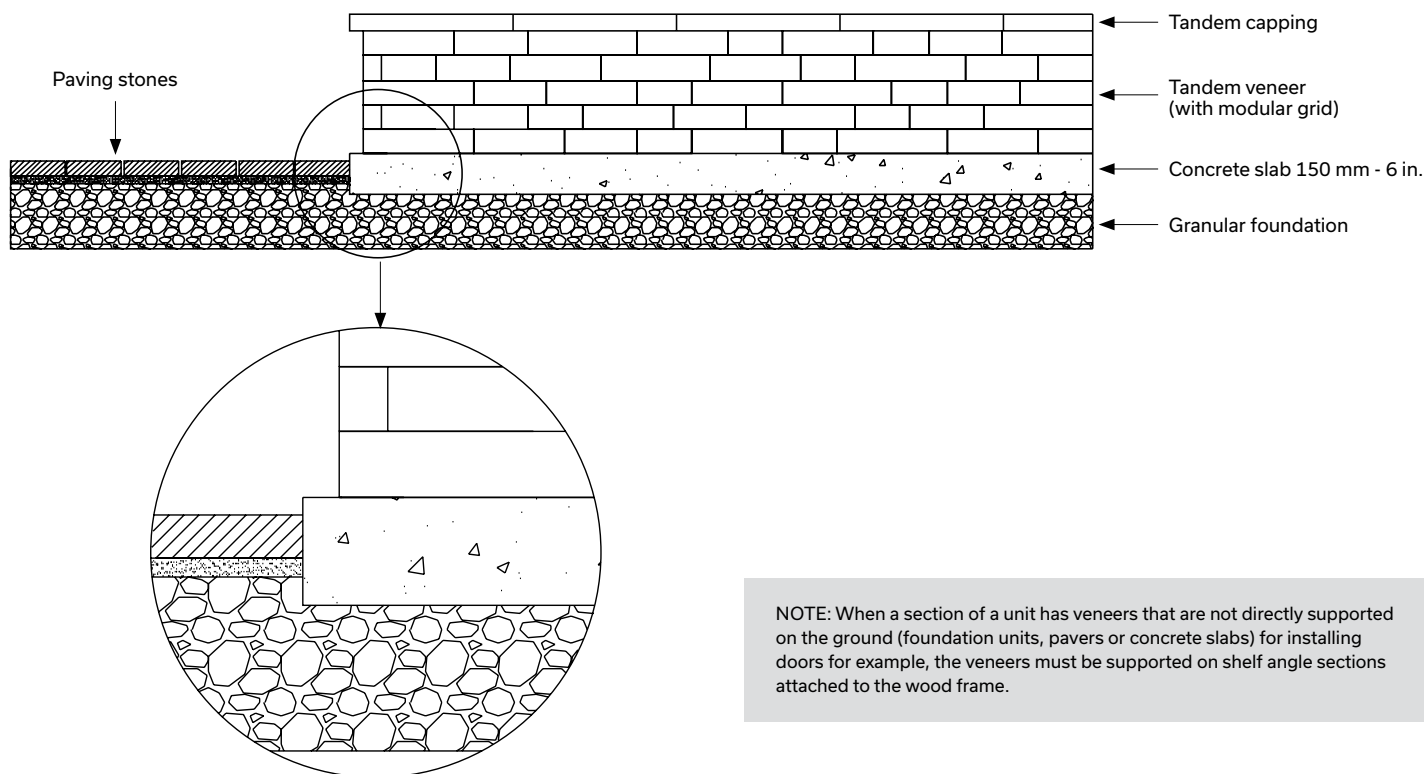

NOTE: When a section of a unit has veneers that are not directly supported on the ground (foundation units, pavers or concrete slabs) for installing doors for example, the veneers must be supported on shelf angle sections attached to the wood frame.

### CONSTRUCTION LUMBER

Building the different units in this guide requires construction lumber for the framing: 2 x 4, 2 x 6 and 2 x 8 boards, 4 x 4 and 6 x 6 posts and plywood sheets. We recommend that all wood used outdoors be treated against rot according to established procedures approved by Health Canada. You should use S-P-F #1 or #2 wood or better. This type of wood usually has a minimum life of 15 years without maintenance in normal outdoor conditions.

NOTE: Wooden components that have been cut or sawed should be treated with an anti-rot product.

### COMPLIANCE WITH CONSTRUCTION STANDARDS

In all circumstances, units to be constructed must always comply with the requirements of the National Building Code (version specific to your region) and local municipal bylaws and regulations.

# Building an Outdoor Gas Fireplace

## CONSTRUCTION OF AN OUTDOOR GAS FIREPLACE

Note that the only type of fireplace recommended for this type of construction is a propane gas or natural gas fireplace. A wood fireplace is not permitted.

Construction should begin with laying a solid foundation that is leveled, compacted and well drained.

The wood framing must be built according to the type of fireplace chosen. Dimensions are calculated using the data on shop drawings provided by the fireplace manufacturer. It may be necessary to add some extra parts like plywood shims for adjusting to the exact modular dimensions of the fireplace (Tandem modular veneers according to the wood frame design).

It is essential to install heat insulation. A fiber cement panel of a minimum thickness of 12 mm - 1/2 in. is recommended for adequate protection. The panels must be installed all around the heating element (burner).

You must also plan to install conduits in the ground for gas pipes and for electric cables if required.

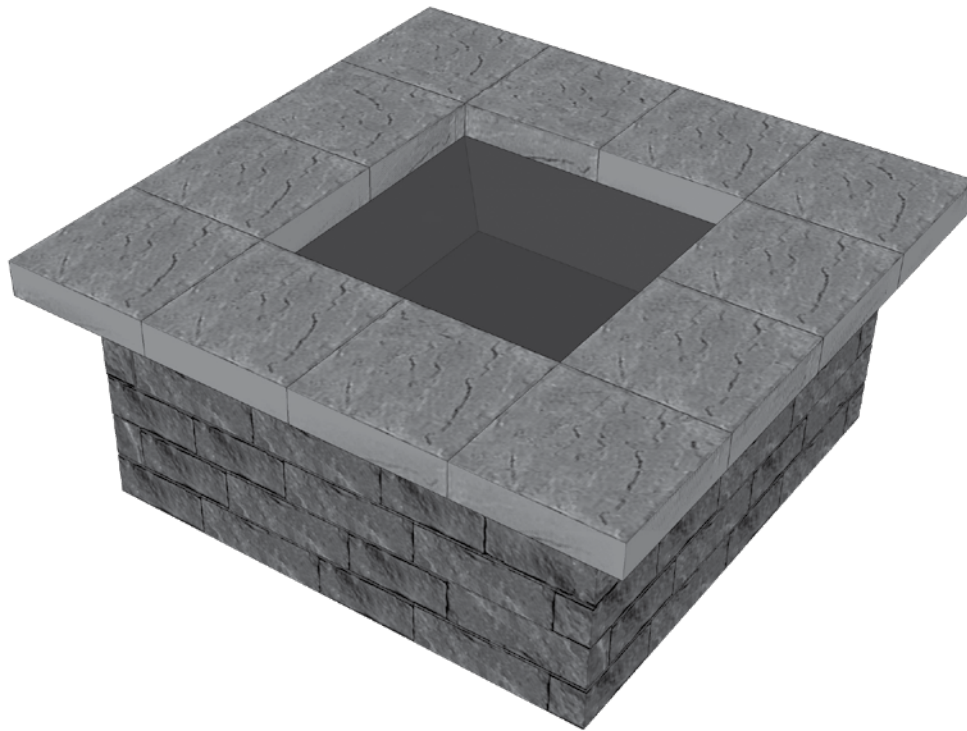



# Building an Outdoor Kitchen

## BUILDING AN OUTDOOR KITCHEN - BARBECUE, REFRIGERATOR, BAR

The wood frame must be constructed according to the type of barbecue chosen. Dimensions are calculated using data on the shop drawings provided by the barbecue manufacturer. Additional accessories such as a fridge or integrated cabinet doors are also possible. Naturally, you have to plan on adding pieces of wood to attach accessories to the wooden structure, like a frame in the case of doors. When purchasing supplies, you will usually find moldings to finish the edges of the various units.

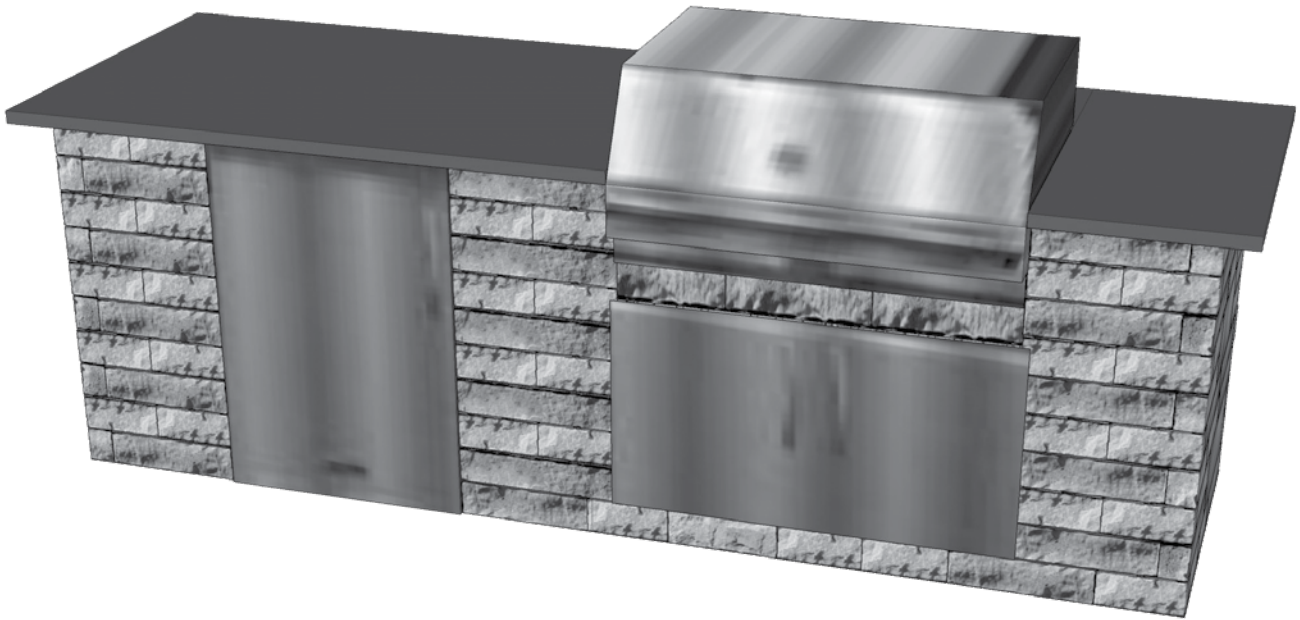

It is essential to install protection from heat and sparks. A fiber cement panel of a minimum thickness of 12 mm - 1/2 in. or a double-skinned steel section if provided by the BBQ manufacturer is recommended for adequate protection. The panels must be installed all around the heating element (burner).

Finish off with concrete capping or panels of granite, quartz, marble or natural stone. The panels must be made to measure by specialized companies. You must make special provisions for handling and installation to avoid possible breakage. The panels are attached on top of the plywood with silicone adhesive to prevent movement.

Provide adequate means for venting gases when constructing the barbecue. (Refer to the barbecue manufacturer's recommendations for the position and size of the ventilation grid required).

You should also plan to install conduits for gas pipes and electric cables. The conduits may in certain cases be installed in the ground.

# Building Patio Furniture

## BUILDING PATIO FURNITURE (TABLE AND BENCH) AND FLOWER BOX

### TABLE

You can make a table by building a Tandem unit (grid and veneers) to form the base and then adding a tabletop. The tabletop can be wood, granite, quartz, marble or natural stone.

Dimensions may vary. It is essential to leave a minimum space between the table edge and the base. At least 460 mm - 18 in. is needed for leg room.

Granite, quartz or marble tabletop: the tabletop must be attached to the veneers with a silicone adhesive. We recommend that a tabletop resting on a Tandem unit be made from a single piece to increase rigidity and stability. This allows you to avoid adding a metal fastener to secure the tabletop to the structure for increased stability and extra protection where necessary. For very large tabletops, it is recommended to install steel supports (angles) to better stabilize the whole unit. You should enquire from the tabletop supplier what are the optimal sizes and thicknesses for stability and security and to avoid possible breakage.

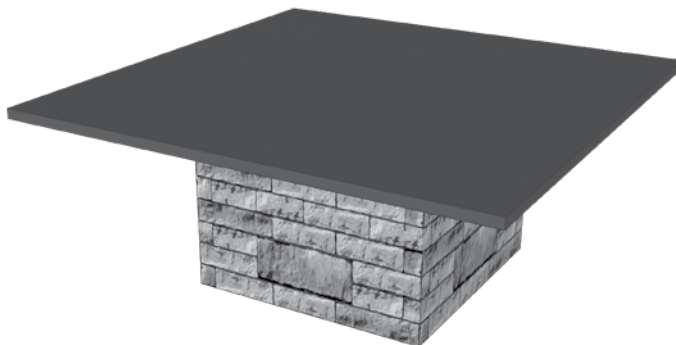

### BENCH

You can make a bench by building a structure for the base and simply adding a concrete capping unit for the seat. Bench dimensions can vary, but it may be helpful to make your decision based on available capping units in order to avoid cuts. For a typical bench, the capping will be of the Melville Plus type.

Bench minimum width is 21 in.

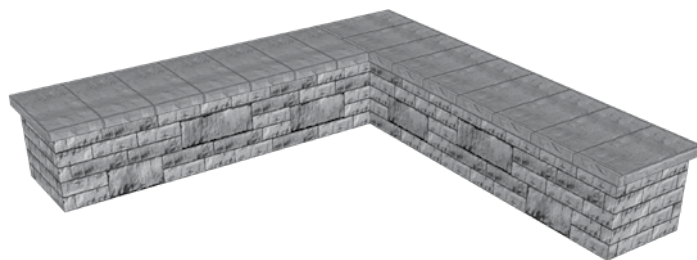

### FLOWER BOX

It is recommended to install a fiber cement panel and a geotextile membrane to protect the wood against deterioration caused by vegetable and mineral materials (plants and soil). You should provide water drainage when building the structure.

For the capping, use the following products for retaining walls: Mondrian 50, Lafitt Plus Tandem, Melville Plus and Celtik capping.

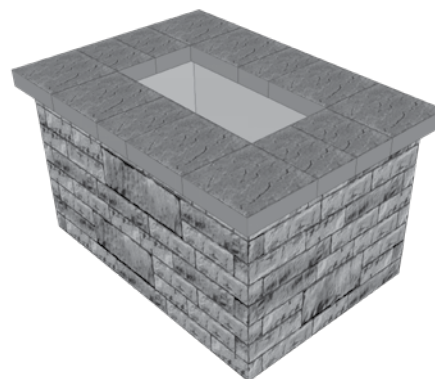

# Building Privacy Walls and Fences

## CONSTRUCTION OF A PRIVACY WALL AND A FENCE

When building a fence or when wanting to hide or conceal various pieces of equipment (e.g. pool filter, heat pump) or utility items (e.g. trashcans or storage bins), the Tandem modular grid system is just what you need.

Fencing is mostly built with treated wood posts (structural, select quality) supported by cast-in-place concrete foundations (Sonotubes) for the main structure. An intermediate structure in treated wood boards is then installed between the posts to attach the fence components of Tandem modular grids and veneers. A shelf angle is fixed to the base of the structure to provide continuous support for the weight of the veneers. The shelf angle (2 1/2 x 2 / 12 x 8 in.) is attached to the base of the structure (wood poles and boards forming the stringer) with suitable screws (#10 x 3 1/2 in.) every 200 mm - 8 in. The shelf angle can be cut to the size of the unit under construction.

The wooden structure between the posts, combined with the shelf angle, supports the weight of the walls and transfers it to the foundations. Fences and privacy walls must rest on pillars (Sonotubes) and concrete foundations to transfer the weight of the walls to the ground. The foundations are also necessary to prevent the walls from collapsing due to the force of the wind.

The dimensions of the foundations in this guide were calculated to respect the weight-bearing capacity of the soil and to limit irregular subsidence that could lead to distortions in the wall. Calculations were made for soil conditions of low weight-bearing

capacity. For different soil conditions, we recommend consulting a qualified engineer. The foundation must be built to withstand local frost conditions. The depth of frost in this guide is 1.8 m - 6 in. The use of screw piles is not recommended for this type of application.

Privacy walls are made with the same main structure to which a perpendicular section is added to obscure non-aesthetic items.

The maximum height of a fence or a privacy wall is limited to 1.8 m - 6 ft.

The maximum length of a wall facade between posts is 2.4 m - 8 ft.

The unit can be built to display its aesthetic appearance on one side or both sides simultaneously.

The wood frame must integrate a bracing panel such as a sheet of 12 mm - 1/2 in. treated plywood to provide a continuous attachment area and stabilize the structure to withstand loads. To finish the walls, attach a cap on top of the wood frame, either in concrete (sizes to be decided on site) or metal (custom bent by a specialized company). Tandem Melville Plus steps can be used to finish the top of a fence or privacy wall.

The capping unit is fixed with a suitable concrete adhesive spread on the wooden structure and the top of veneers. It may be useful to fix the wooden structure to the concrete cap with a metal attachment to provide additional wind protection.



PRIVACY WALL

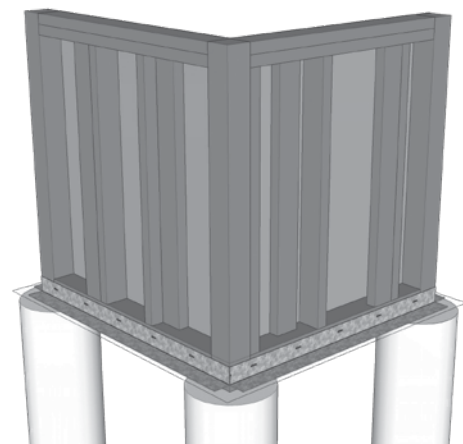

PRIVACY WALL on concrete pillar (Sonotube) - construction details of wooden structure

# CONSTRUCTION OF OUTDOOR LIVING COMPONENTS WITH THE TANDEM MODULAR GRID

## DESIGN DATA FOR FENCES

Since unit components will vary according to height from 0 to 1.8 m - 6 in., we present the main minimum requirements in table form.

FENCE WITH VENEER ON ONE SIDE					
FENCE HEIGHT	Ø PILASTER	FOOTING	EMBEDDING POST	POST	STRUCTURE
0 to 4 ft. OPTION 1	300 mm - 12 in.	Ø 600 mm - 24 in.	600 mm - 24 in.	4 x 4*	2 x 4
OPTION 2	300 mm - 12 in.	400 x 400 mm - 16 x 16 in.	600 mm - 24 in.	4 x 4*	2 x 4
OPTION 3	600 mm - 24 in.	N/A	600 mm - 24 in.	4 x 4*	2 x 4
4 to 5 ft. OPTION 1	300 mm - 12 in.	Ø 600 mm - 24 in.	600 mm - 24 in.	6 x 6**	2 x 6
OPTION 2	300 mm - 12 in.	400 x 400 mm - 16 x 16 in.	600 mm - 24 in.	6 x 6**	2 x 6
5 to 6 ft. OPTION 1	300 mm - 12 in.	Ø 600 mm - 24 in.	600 mm - 24 in.	6 x 6**	2 x 6
OPTION 2	300 mm - 12 in.	500 x 500 mm - 20 x 20 in.	600 mm - 24 in.	6 x 6**	2 x 6
FENCE WITH VENEER ON BOTH SIDES					
0 to 4 ft. OPTION 1	300 mm - 12 in.	Ø 600 mm - 24 in.	600 mm - 24 in.	4 x 4*	2 x 4
OPTION 2	300 mm - 12 in.	500 x 500 mm - 20 x 20 in.	600 mm - 24 in.	4 x 4*	2 x 4
4 to 5 ft. OPTION 1	300 mm - 12 in.	Ø 600 mm - 24 in.	600 mm - 24 in.	6 x 6**	2 x 6
OPTION 2	300 mm - 12 in.	500 x 500 mm - 20 x 20 in.	600 mm - 24 in.	6 x 6**	2 x 6
5 to 6 ft. OPTION 1	300 mm - 12 in.	Ø 600 mm - 24 in.	600 mm - 24 in.	6 x 6**	2 x 6
OPTION 2	300 mm - 12 in.	550 x 550 mm - 22 x 22 in.	600 mm - 24 in.	6 x 6**	2 x 6

N/A: Not Applicable \* 4 x 4 SFP wood select structural \*\* 6 x 6 #1 SFP wood

It should be noted that the base of concrete pillars should normally have a wider section in the ground for a footing. The footing can take two shapes, square or round. There are round footings on the market, sold as BIGFOOT, which can be used for the construction of pillars. Square footings must be made on site with wooden formwork.

# CONSTRUCTION OF OUTDOOR LIVING COMPONENTS WITH THE TANDEM MODULAR GRID

## CAMOUFLAGE SCREEN DESIGN DATA

As the components of an element vary according to height (from 0 to 1.8 m - 6 ft.) we present in table form the main minimum criteria to consider.

WALL WITH VENEER ON ONE SIDE					
WALL HEIGHT	Ø PILASTER	FOOTING	EMBEDDING POST	POST	STRUCTURE
<b>L1 and L2 configuration = 1.2 m - 4 ft.</b>					
0 to 3 ft.	400 mm - 16 in.	N/A	600 mm - 24 in.	4 x 4*	2 x 4
3 to 6 ft. OPTION 1	600 mm - 24 in.	N/A	600 mm - 24 in.	6 x 6	2 x 6
OPTION 2	300 mm - 12 in.	400 x 400 mm - 16 x 16 in.	600 mm - 24 in.	6 x 6	2 x 6
OPTION 3	300 mm - 12 in.	Ø 600 mm - 24 in.	600 mm - 24 in.	6 x 6	2 x 6
<b>L1 configuration = 2.4 m - 8 ft. and L2 = 1.2 m - 4 ft.</b>					
0 to 4 ft. OPTION 1	600 mm - 24 in.	N/A	600 mm - 24 in.	4 x 4*	2 x 4
OPTION 2	300 mm - 12 in.	400 x 400 mm - 16 x 16 in.	600 mm - 24 in.	4 x 4*	2 x 4
4 to 5 ft. OPTION 1	600 mm - 24 in.	N/A	600 mm - 24 in.	6 x 6**	2 x 6
OPTION 2	300 mm - 12 in.	400 x 400 mm - 16 x 16 in.	600 mm - 24 in.	6 x 6**	2 x 6
OPTION 3	300 mm - 12 in.	Ø 600 mm - 24 in.	600 mm - 24 in.	6 x 6**	2 x 6
5 to 6 ft. OPTION 1	300 mm - 12 in.	400 x 400 mm - 16 x 16 in.	600 mm - 24 in.	6 x 6**	2 x 6
OPTION 2	300 mm - 12 in.	Ø 600 mm - 24 in.	600 mm - 24 in.	6 x 6**	2 x 6
WALL WITH VENEER ON BOTH SIDES					
<b>L1 and L2 configuration = 1.2 m - 4 ft.</b>					
0 to 4 ft.	400 mm - 16 in.	N/A	600 mm - 24 in.	4 x 4*	2 x 4
4 to 6 ft. OPTION 1	300 mm - 12 in.	400 x 400 mm - 16 x 16 in.	600 mm - 24 in.	6 x 6	2 x 6
OPTION 2	300 mm - 12 in.	400 x 400 mm - 16 x 16 in.	600 mm - 24 in.	6 x 6	2 x 6
<b>L1 configuration = 2.4 m - 8 ft. and L2 = 1.2 m - 4 ft.</b>					
0 to 3 ft. OPTION 1	600 mm - 24 in.	N/A	600 mm - 24 in.	4 x 4*	2 x 4
3 to 4 ft. OPTION 1	300 mm - 12 in.	400 x 400 mm - 16 x 16 in.	600 mm - 24 in.	4 x 4*	2 x 4
OPTION 2	300 mm - 12 in.	Ø 600 mm - 24 in.	600 mm - 24 in.	4 x 4*	2 x 4
4 to 6 ft. OPTION 1	300 mm - 12 in.	400 x 400 mm - 16 x 16 in.	600 mm - 24 in.	6 x 6**	2 x 6
OPTION 2	300 mm - 12 in.	Ø 600 mm - 24 in.	600 mm - 24 in.	6 x 6**	2 x 6

N/A: Not Applicable \* 4 x 4 SFP wood select structural \*\* 6 x 6 #1 SFP wood

It should be noted that the base of concrete pillars should normally have a wider section in the ground for a footing. The footing can take two shapes, square or round. There are round footings on the market, sold as BIGFOOT, which can be used for the construction of pillars. Square footings must be made on site with wooden formwork.

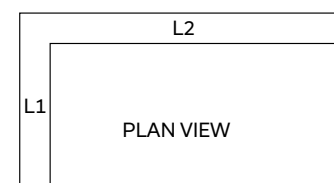

## DESIGN ASSUMPTIONS

The construction of privacy walls or fences must take into account the following assumptions:

- > Wall weight (grid and veneers): 28 lbs/ft<sup>2</sup> (1.35 kN/m<sup>2</sup>)
- > Wind: 20 lbs/ft<sup>2</sup> (1 kPa)
- > Minimum allowable bearing capacity of soil: 1575 lbs/ft<sup>2</sup> (75 kPa)
- > Density of soil around pillars and foundations (γ): 18 kN/m<sup>3</sup>
- > Backfill must be compacted around Sonotubes and spread footings

- > Minimum depth of foundations: 6 ft ( 1.8 m} away from frost (consult an engineer to check the typical depth of frost for your area) It may be necessary to consult an engineer.

Leave a free space under the Tandem wall of at least 75 mm - 3 in. to ensure proper ventilation and adequate room for the potential effects of freezing and thawing.

NOTE: Design assumptions do not take into account earthquake effects. It may be necessary to consult an engineer.

**PRIVACY WALL AND FENCE - TYPICAL FRONT VIEW**

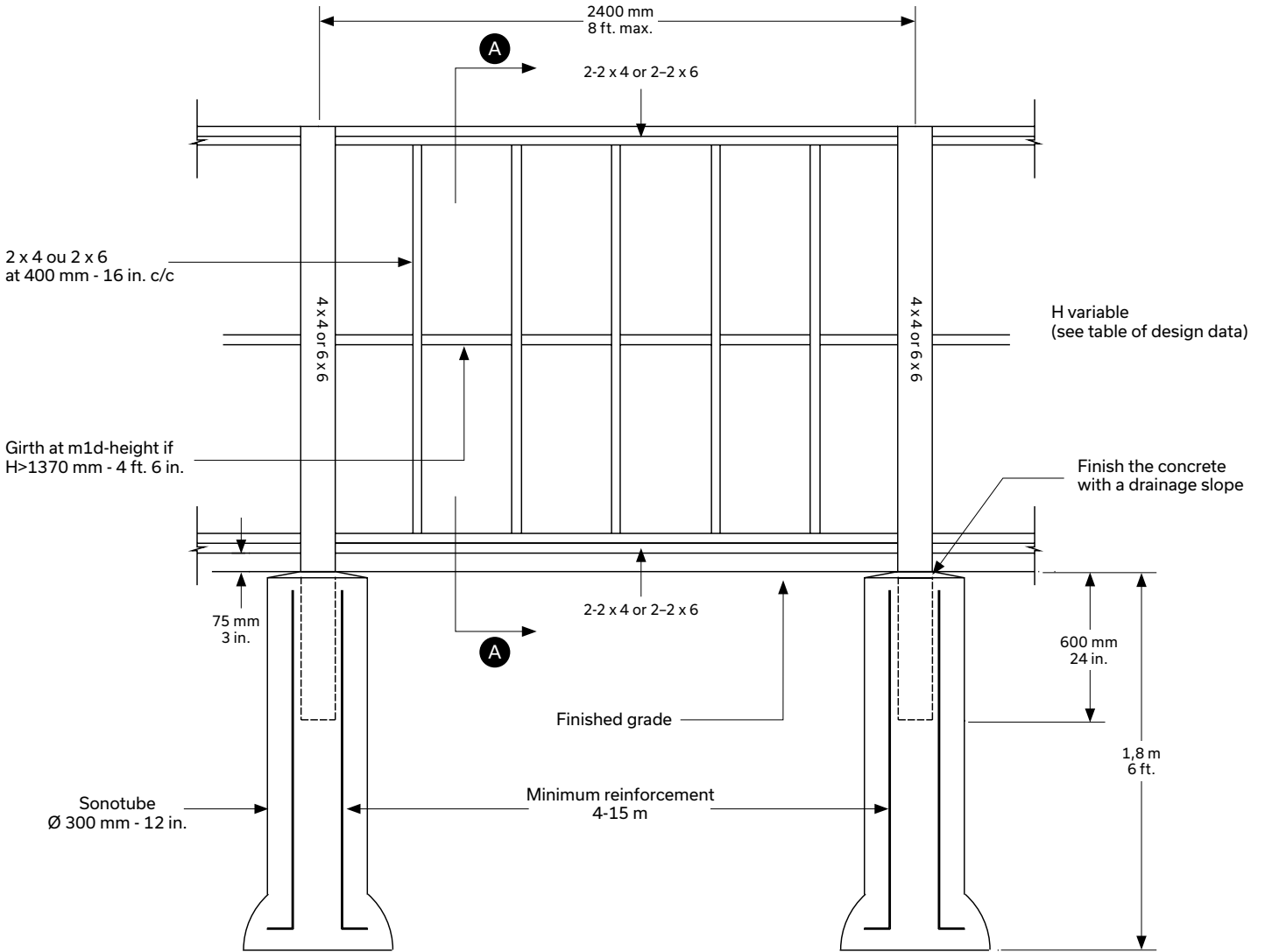

**FOOTING**  
For different footing options, see the design data chart.

NOTE: The details shown here are only valid for the application suggested in this guide, taking into account the prescribed limitations. You are strongly recommended to engage a structural engineer or specialist in the field to validate structural design details for other configurations or for different soil conditions (lower or higher load capacity, presence of blocks, support on rock, etc.).

**PRIVACY WALL AND FENCE - CROSS-SECTION A-A**

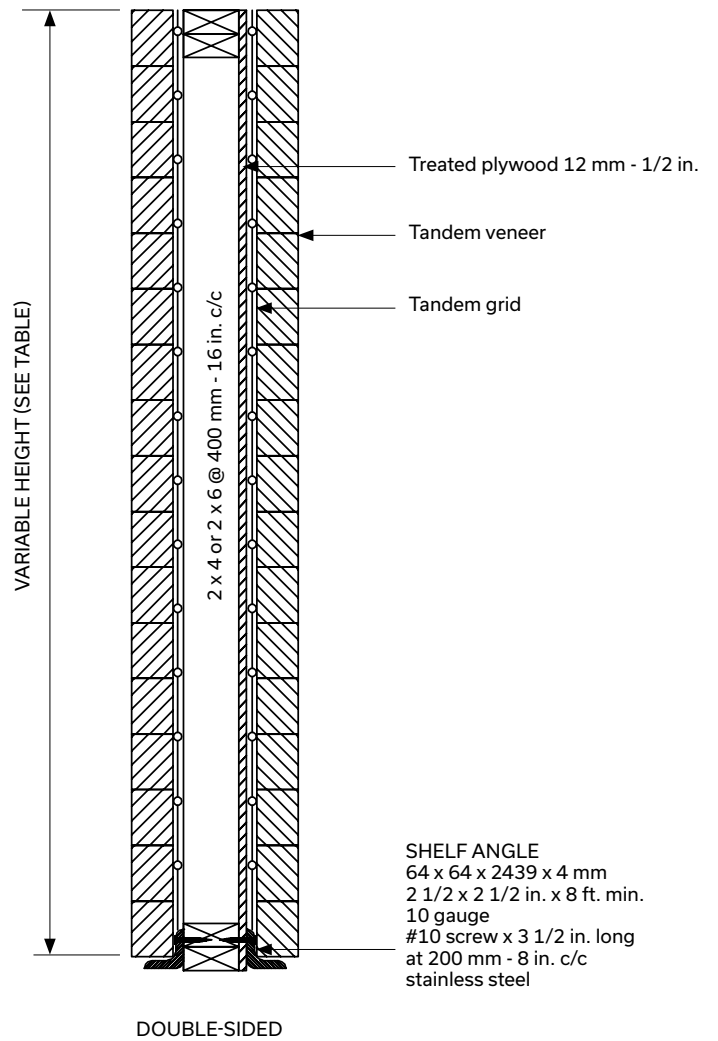
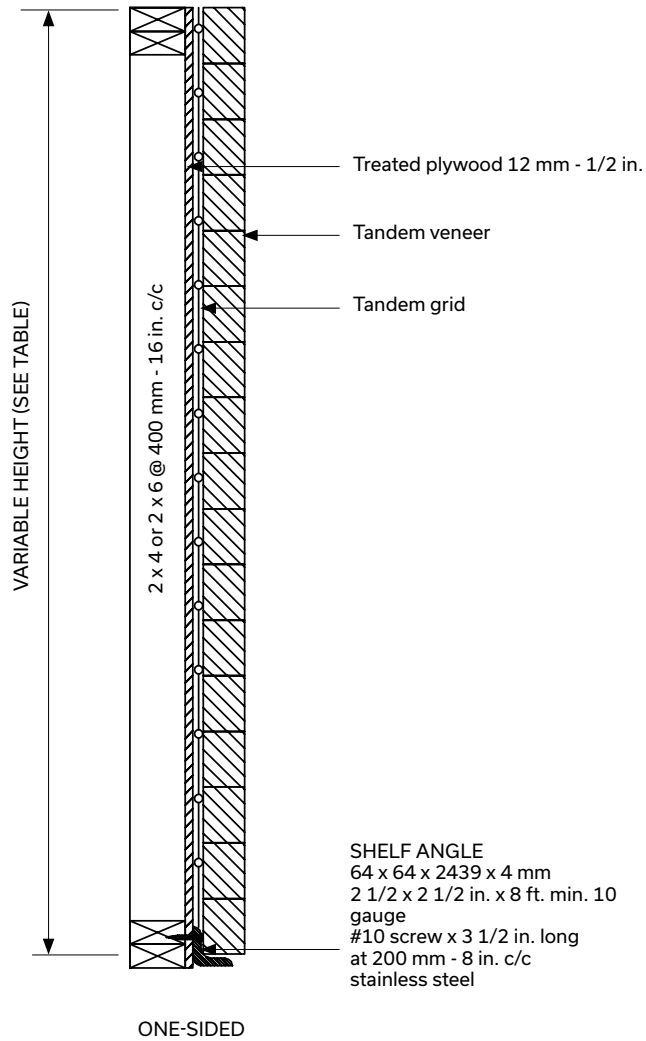



**WOODEN STRUCTURE SCREW DIAGRAM OF COMPONENTS**

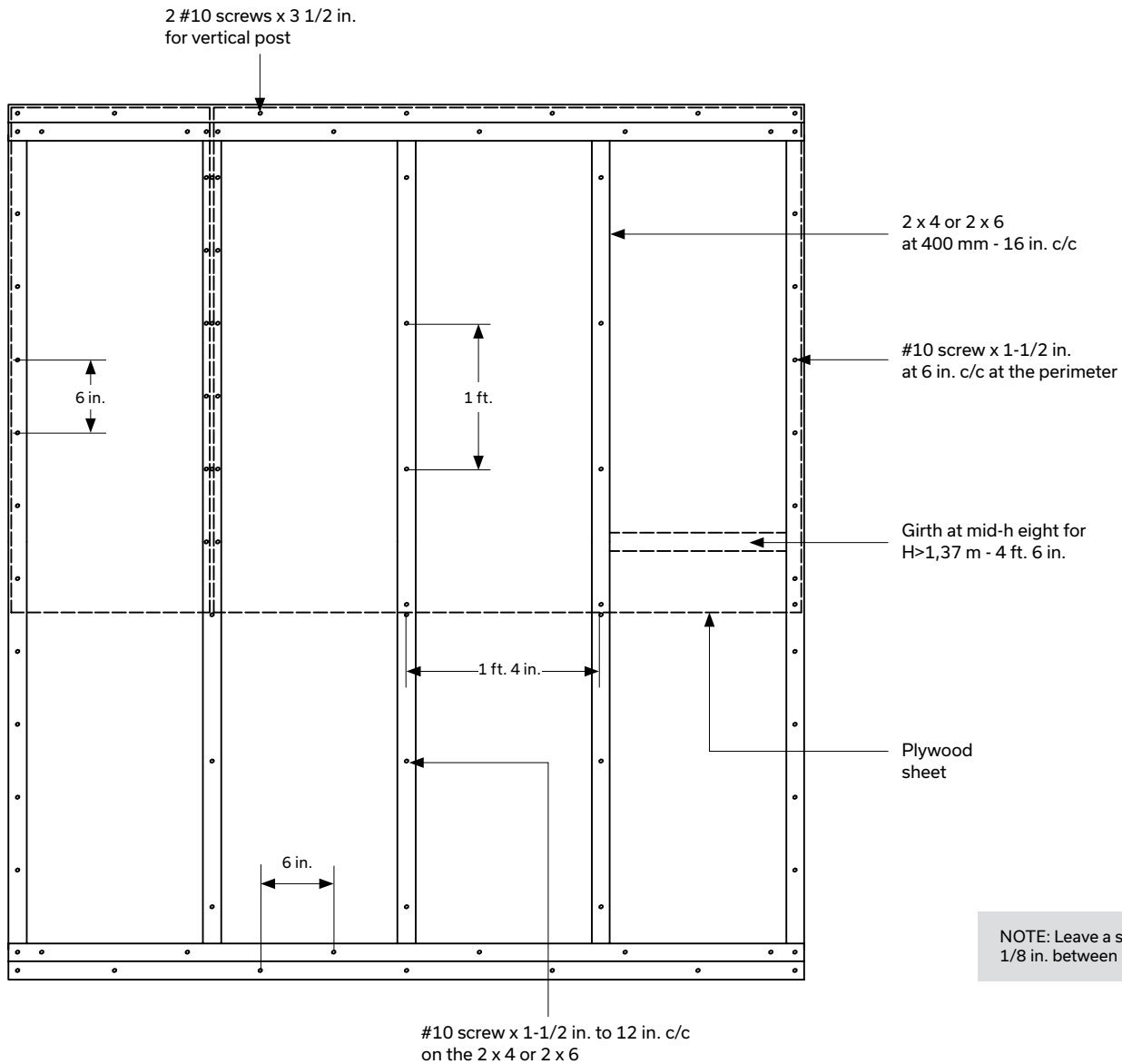

NOTE: Leave a space of 2-3 mm - 1/8 in. between plywood sheets

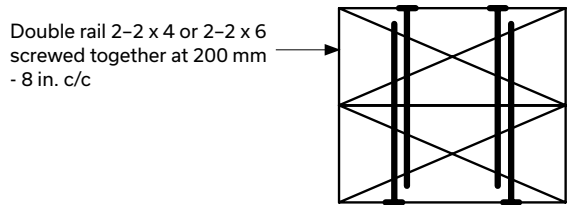

Assembly 2-2 x 4 or 2-2 x 6 #10 screw x 3 1/2 in. long staggered

**BUILDING DECK SKIRTING**

**APPLICATIONS:  
NEW WOOD OR CONCRETE DECKS OR EXISTING CONCRETE DECKS**

Another application of the Tandem grid consists of covering the free space under a deck by building a Tandem wall around it. Tandem veneers are supported by a galvanized shelf angle and a wood frame fixed to the deck (wood or concrete). The wood frame consists of treated plywood to provide a continuous attachment area for the grid, and vertical bracing to stabilize the structure and withstand lateral loads such as the wind. The whole structure is supported by appropriate foundations (screw piles for wooden decks and concrete foundations for concrete decks).

**MAXIMUM HEIGHT OF TANDEM WALL: 1.5 m - 5 fl.**

To install deck skirting on existing concrete structures, you must first ensure that the initial structure (the deck itself) can bear the additional weight of new covering components, wooden structure, shelf angle and Tandem veneers.

For this kind of project, it is strongly recommended to engage a structural engineer or specialist in the field to validate the structural design details for adequate load bearing.

In all cases, it is necessary to minimally comply with the design criteria shown below:

- > Wall weight (grid and veneers): 1.35 KN/m<sup>2</sup> (28 lb/sq.ft.)
- > Wind: 1 kPa (21 lb/sq.ft.)
- > Overload: 1.9 kPa (40 lb/sq.ft.)

**MINIMUM ALLOWABLE BEARING CAPACITY OF SOIL:  
75 KPA (1575 lbs/sq.ft.)**

NOTE: Design assumptions do not take into account earthquake effects. It may be necessary to consult an engineer.

Minimum depth of foundations in soil: 1.8 m - 6 ft. away from frost (consult an engineer to check the typical depth of frost for your area).

Leave a free space of at least 75 mm - 3 in. under the Tandem wall.

NOTE: As there is no direct access from the top of a unit (since the Tandem wall is built under the deck), it will be impossible to attach the last row of veneers to the Tandem grid with connectors. Simply glue the last row of veneers to the second-to-last row with Techniseal concrete adhesive.

The sketches shown here have been designed to withstand the additional loads of Tandem walls. The details shown are valid for applications suggested in this guide. It is strongly recommended to engage a structural engineer or specialist in the field to validate structural design details for other configurations.

NOTE: Please consult your Permacon sales representative for more information on how to create a curved wall.

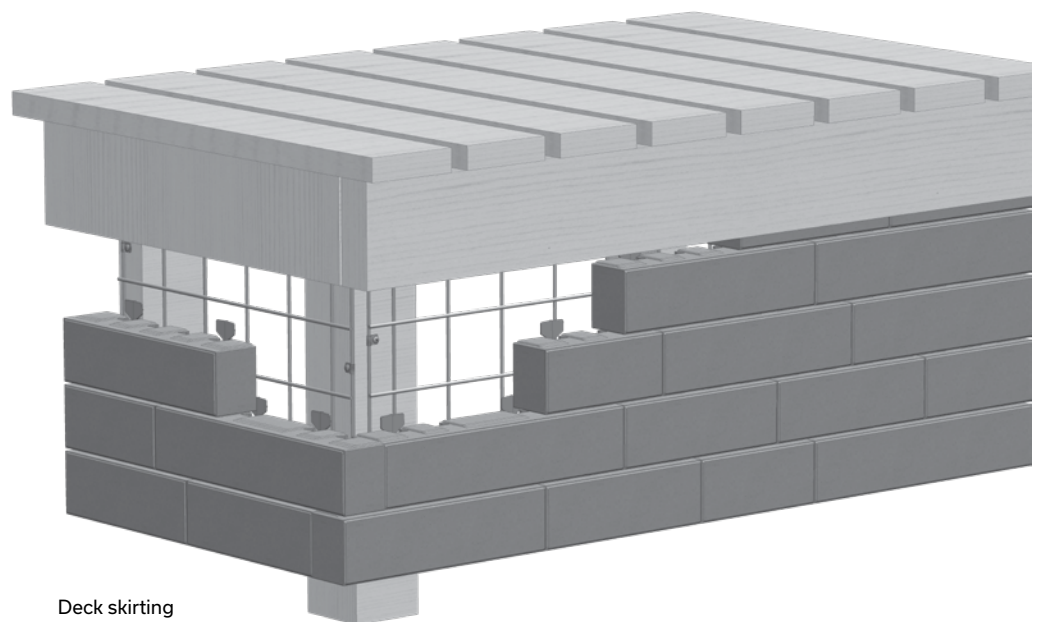

Deck skirting  
ISOMETRIC VIEW

# CONSTRUCTION OF OUTDOOR LIVING COMPONENTS WITH THE TANDEM MODULAR GRID

## CONCRETE DECK

To cover a concrete deck, you must comply with additional minimum design criteria detailed below:

THE MINIMUM THICKNESS OF THE SLAB should be 140 mm - 5 1/2 in.

The slab should be reinforced with a minimum IOM reinforcement at 300 mm - 12 in. c / c in both directions and positioned at the center of the slab. The concrete deck should be supported by pillars of reinforced concrete (Sonotubes), 200 mm - 8 in. in diameter with a minimum footing of 600 mm - 24 in. or larger in diameter.

The compressive strength of the concrete (slab and pillars) must be at least 30 MPa with 5% to 8% entrained air.

MAXIMUM DISTANCE BETWEEN PILLARS: 2400 mm - 8 ft.

MAXIMUM OVERHANG OF CONCRETE SLAB: 600 mm - 2 ft.

To attach the components of the wooden structure to the concrete slab, you should use mechanical anchors like Hilti Kwik Bolt TZ (12 mm diameter by 140 mm long) or equivalent (not supplied by Permacon).

Leave a space of at least 12 mm - 1/2 in. between the top of the Tandem wall and the underside of the concrete slab.

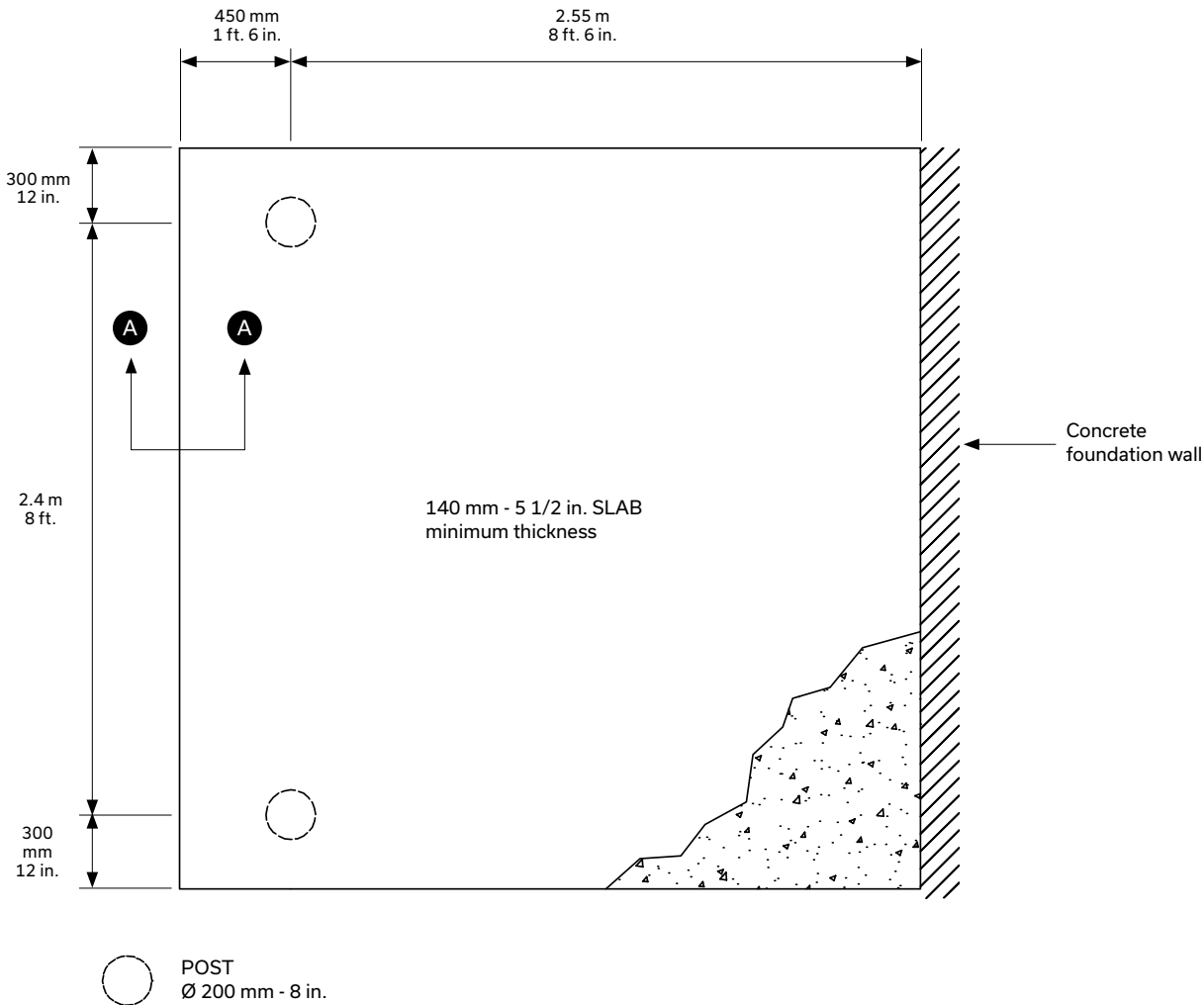

Concrete deck skirting  
PLAN VIEW

**CONCRETE DECK SKIRTING - CROSS-SECTION A-A**

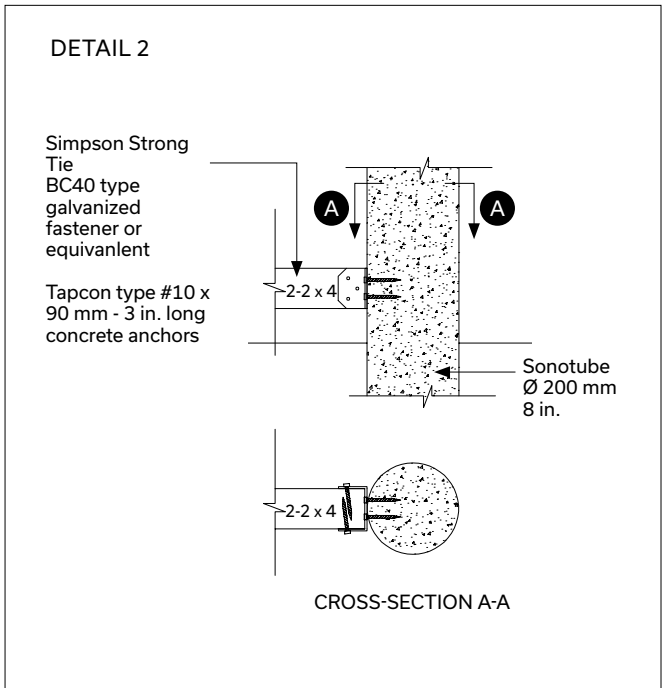
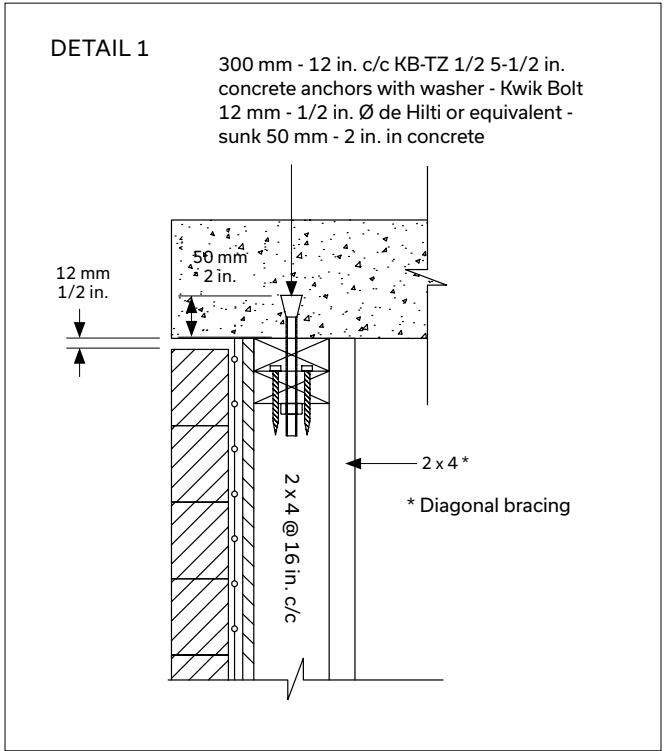
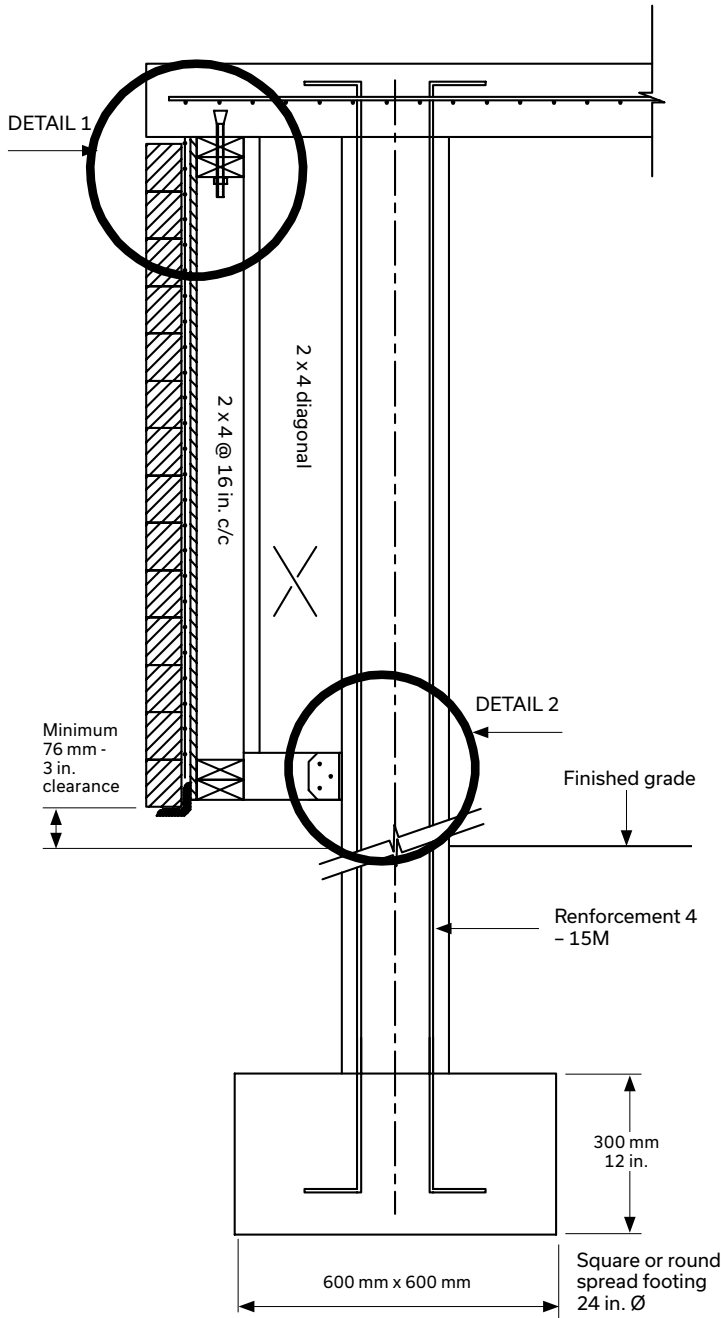

**WOOD DECK**

**WARNING: We recommend installing a Tandem wall only for new wooden decks to be built according to the minimum specifications and data detailed below.**

The wooden deck should be built with a structure composed of 2 x 8 joists spaced every 400 mm - 16 in. or less. The deck beams must be made of at least two 2 x 8 boards.

The beams are supported on 89 x 89 mm - 4 x 4 in. wooden posts. The posts themselves are supported on screw piles designed for this purpose (helical piles).

MAXIMUM LENGTH OF WOOD JOISTS IN BOTH DIRECTIONS: 2400 mm - 8 ft.

MINIMUM OVERHANG of 300 mm - 12 in. and MAXIMUM OVERHANG of 600 mm - 2 ft.

To attach the components of the wooden structure to the deck joists, you should use #10 stainless steel wood screws.

Simpson Strong-Tie hardware (or equivalent) should be used.

A waterproofing membrane must be installed on top of the wood frame to protect the wood from water saturation and rot (in the case of wood board flooring with free space). The membrane can be omitted for waterproof deck flooring such as fiberglass.

It is recommended to leave a space of 1/8 to 1/4 in. between the wooden boards of the deck for ventilation under the deck so as not to trap moisture.

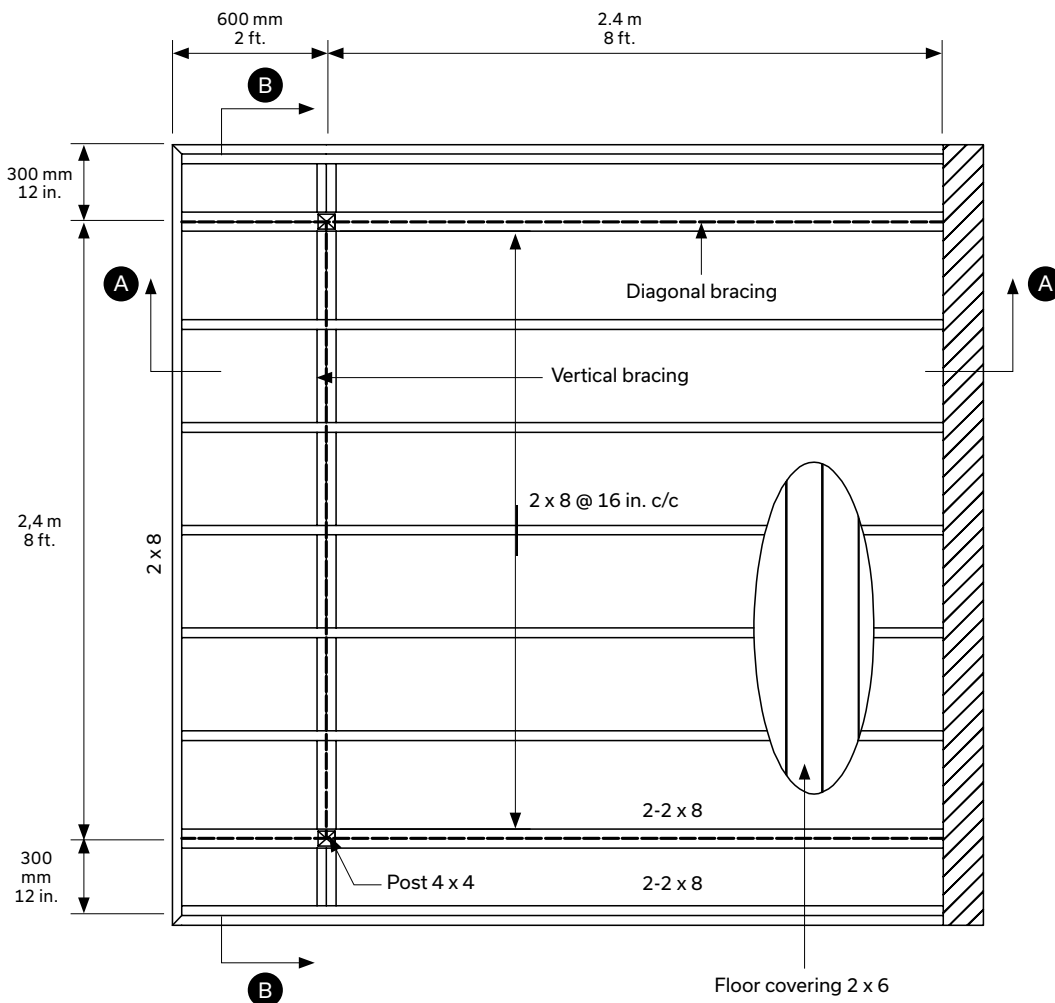

Floor structure - PLAN VIEW

# CONSTRUCTION OF OUTDOOR LIVING COMPONENTS WITH THE TANDEM MODULAR GRID

## WOODEN DECK SKIRTING - CROSS-SECTION A-A

- A Simpson Strong-Tie LUS 26 and LUS 26-2 (GA 18) galvanized steel joist hangers or equivalent
- B 2x8 continuous rail attached to foundation wall with Hilti KB-TZU 12 x 140 mm - 1/2 in. x 5 1/2 in. anchors or equivalent  
*Alternative: joists resting on foundation wall*
- C Diagonal brace at mid-height for wall over 1200 mm - 4 in. tall
- D Floor coverings 2 x 6 spaced at 6 mm - 1/4 in.

NOTE: During construction, 2 x 4 posts should face floor joists to enable assembly construction.

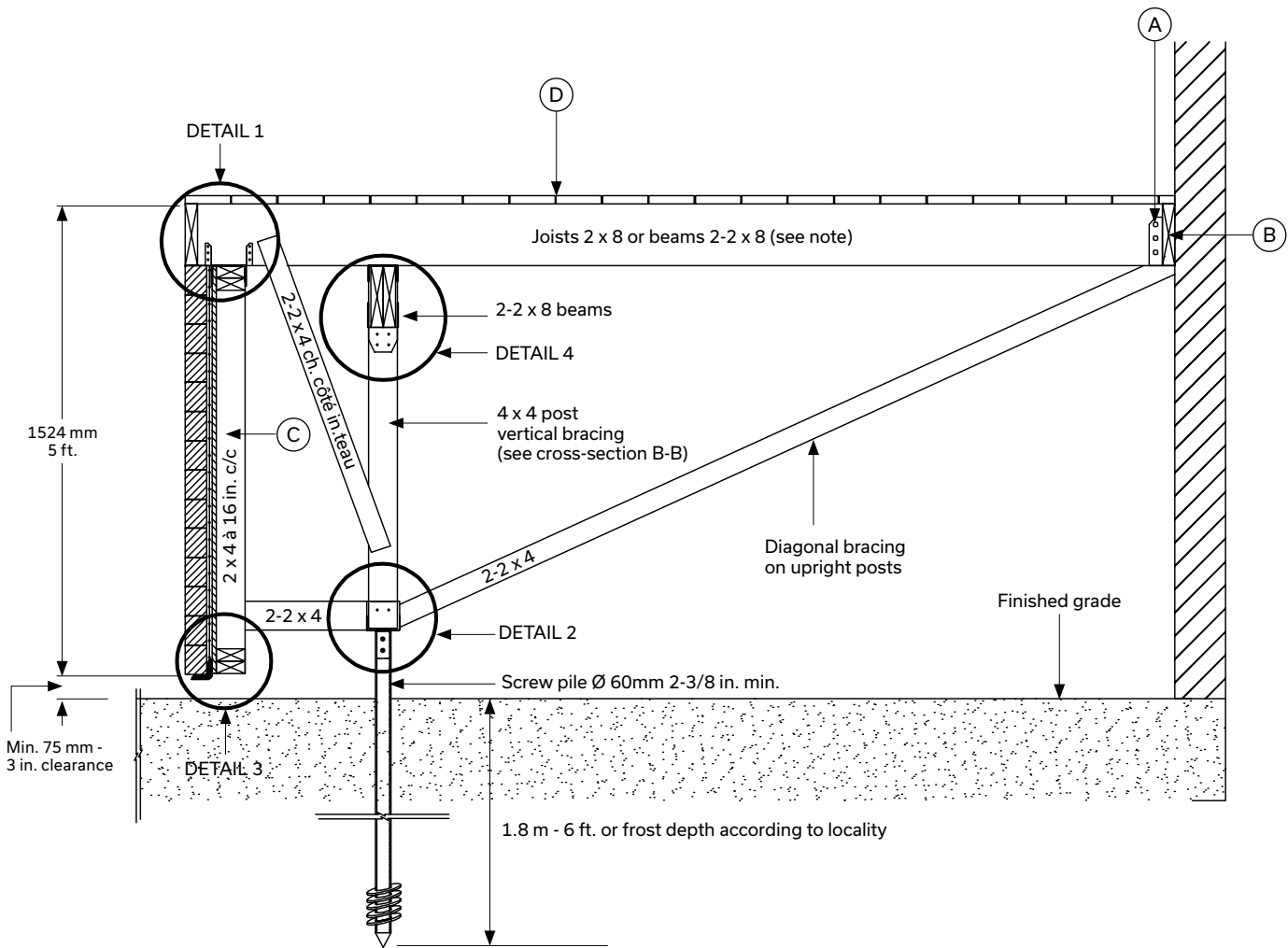

**WOODEN DECK SKIRTING - CROSS-SECTION B-B**

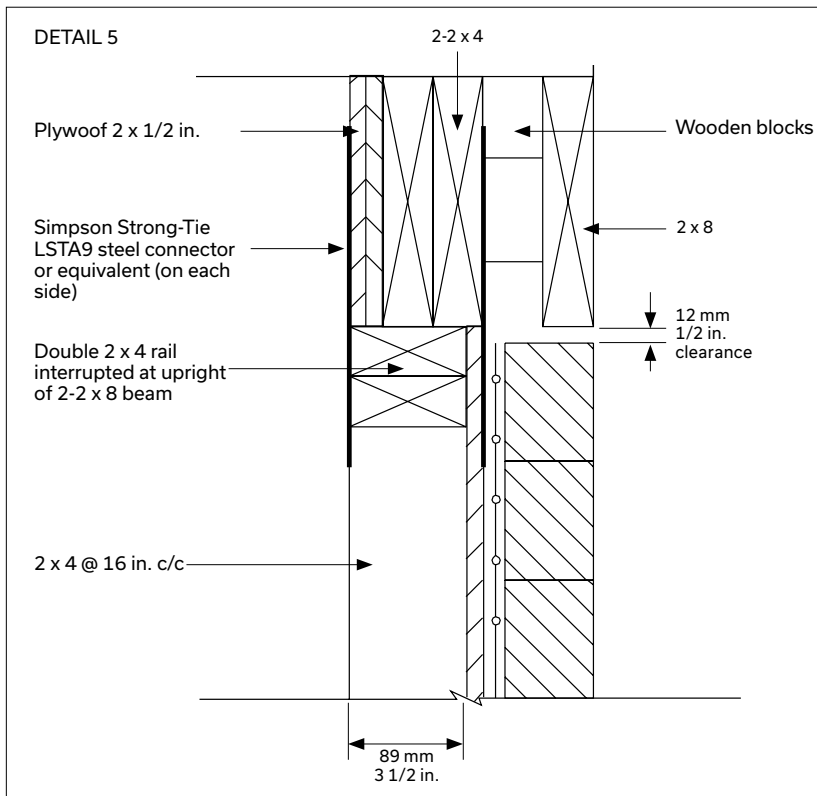
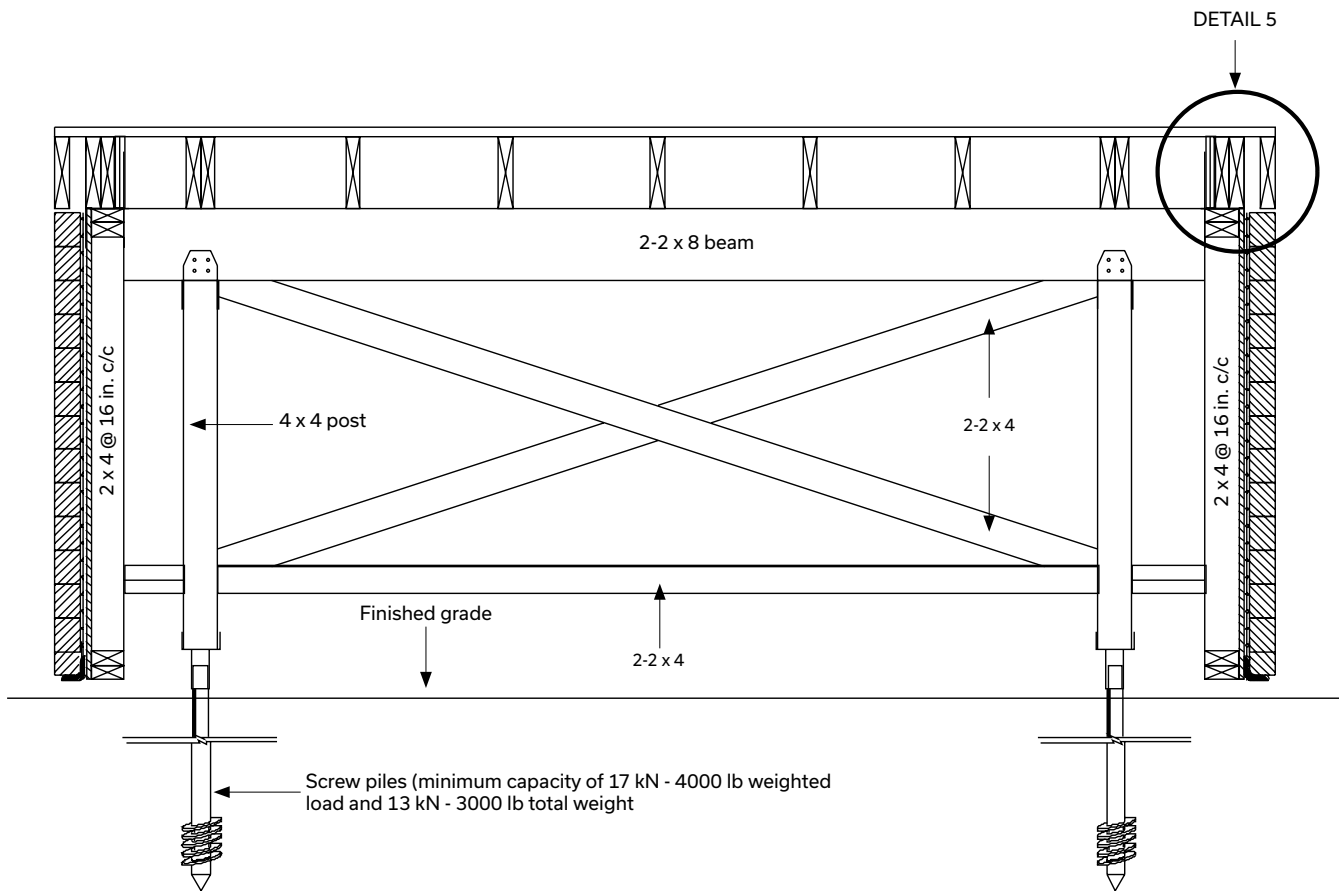



**WOODEN DECK SKIRTING DETAILS - CROSS-SECTION A-A**

