

BUILDING PILLARS

LAFITT AND MELVILLE TANDEM PILLAR WITH 90 mm UNITS (CONT'D)

PILLAR

737 x 737 mm - 29 x 29 in.

1st ROW

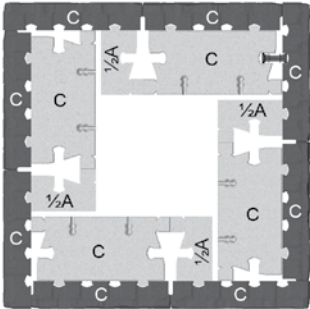

Veneer C with textured end

2nd ROW

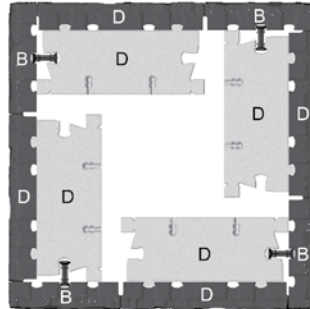

Veneer B with textured end

3rd ROW

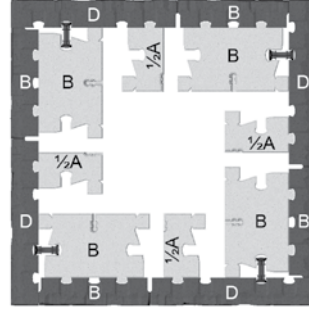

Veneer D with textured end

4th ROW

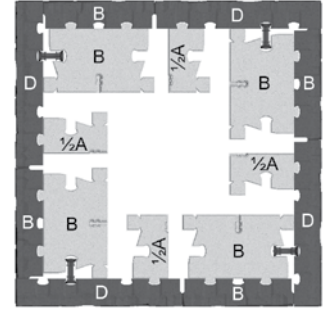

Veneer D with textured end

5th ROW

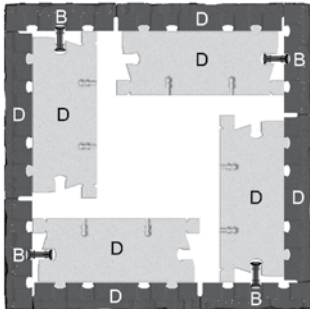

Veneer B with textured end

6th ROW

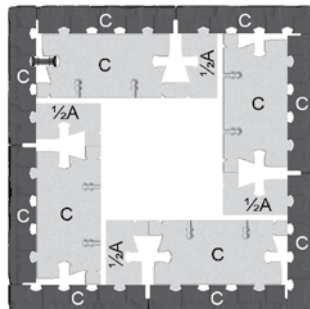

Veneer C with textured end

7th ROW

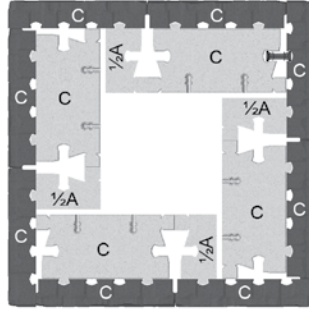

Veneer C with textured end

8th ROW

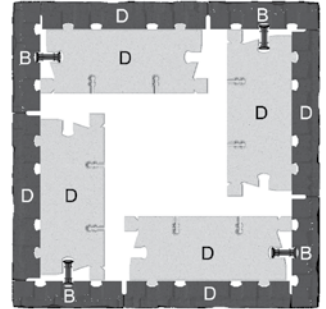

Veneer B with textured end

9th ROW

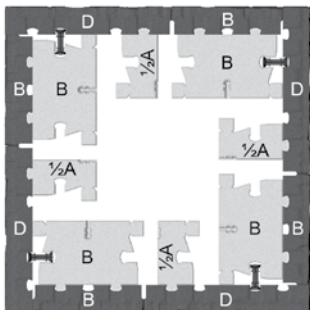

Veneer D with textured end

LAYING PATTERN

TANDEM 90 mm PILLAR
First 9 rows (over starter units)
810 mm - 31 7/8 in.

LEGEND

- D** Veneer D with textured end
- C** Veneer C with textured end
- B** Veneer B with textured end
- A** Veneer A with textured end

Installation pattern to repeat up to
DESIRED HEIGHT

D	B	D	9 th ROW
B	D	B	8 th ROW
C	C	C	7 th ROW
C	C	C	6 th ROW
B	D	B	5 th ROW
D	B	D	4 th ROW
D	B	D	3 rd ROW
B	D	B	2 nd ROW
C	C	C	1 st ROW

BASIC PRINCIPLES

A set of Tandem modular grids is attached to a structure of treated wood to which are attached Tandem veneer units (Lafitt or Melville). Since veneer units are manufactured in multiples of 67 mm, the overall dimensions of outdoor units should always be a multiple of 67 mm in order to avoid cuts. The wooden structure should be built taking into account the modular design of Tandem veneers. The same applies to the height, which must be a multiple of 90 mm. The item is finished off with an appropriate capping unit. You can construct a range of outdoor units of various dimensions.

MAIN COMPONENTS OF THE SYSTEM

- > Tandem modular grid, 720 x 1080 mm - 28 x 42 1/2 in., including stainless steel screws and loop clamps for fastening. A modular grid covers a facing surface of 0.78 m² - 8.40 sq.ft.). Each modular grid includes a kit of 60 connectors, 10 x 1 1/4 in. screws and 10 loop clamps.
- > Tandem veneer units (Lafitt or Melville)
- > Galvanized shelf angle (for deck skirting, privacy walls and fences) 64 x 64 x 2439 mm - 2 1/2 x 2 1/2 x 8 ft. (min 10 gauge, Z275 G90 galvanized steel, ASTM A653 Grade 33)
- > Permacon concrete capping unit (Lafitt, Melville et Mondrian Plus along with Celtik capping)

OTHER COMPONENTS NOT SUPPLIED BY PERMACON

- > Treated Wood: 2 x 4, 2 x 6 and 2 x 8 boards, 4 x 4 or 6 x 6 posts, 4 x 8 plywood sheets (all wood should be treated against rot and must be category S-P-F #1 or better). Refer to the various suppliers' specific application sheets for details.
- > Fiber cement panels 1220 x 2240 x 12 mm (48 x 96 x 1/2 in.)
- > # 10 screws of varying lengths, nuts, bolts and washers where required, all in stainless steel. It is not recommended to use treated wood screws (green ceramic) or metal plated screws (zinc, copper or other)
- > Hilti Kwik Bolt-type anchors (for concrete deck skirting)
- > Simpson Strong-Tie-type hardware for construction of wood frame for deck
- > Custom countertops made of granite, quartz, marble and natural stone as alternatives to concrete tops

CONSTRUCTION OF OUTDOOR LIVING COMPONENTS WITH THE TANDEM MODULAR GRID

WOOD FRAMING

You must always take the modular design of Tandem Veneers into account when constructing wood framing. The overall dimensions of outdoor units must always be a multiple of 67 mm in length and width and 90 mm in height. When installing the framing, remember that grids need a 16 mm - 3/8 in. space between the veneer and the frame.

Bearing this in mind, the following tables show detailed measurements for the framing of units. These tables are very useful for quickly calculating the actual dimensions of the wood framing and the unit to be constructed to build the component without any veneers cut.

**TABLE OF COMPONENTS AND WOOD FRAME DIMENSIONS
BASED ON THE MODULAR FORMAT OF VENEERS**

DIM A (mm)	DIM A (in.)	DIM B (mm)	DIM B (in.)
201	7 15/16	35	1 3/8
268	10 9/16	102	4
335	13 3/16	169	6 5/8
402	15 13/16	236	9 5/16
469	18 7/16	303	11 15/16
536	21 1/8	370	14 9/16
603	23 3/4	437	17 3/16
670	26 3/8	504	19 13/16
737	29	571	22 1/2
804	31 5/8	638	25 1/8
871	34 5/16	705	27 3/4
938	36 15/16	772	30 3/8
1005	39 9/16	839	33 1/16
1072	42 3/16	906	35 11/16
1139	44 13/16	973	38 1/4
1206	47 1/2	1040	40 15/16
1273	50 1/8	1107	43 9/16
1340	52 3/4	1174	46 1/4
1407	55 3/8	1241	48 7/8
1474	58 1/16	1308	51 1/2
1541	60 11/16	1375	54 1/8
1608	63 5/16	1442	56 3/4
1675	65 15/16	1509	59 3/8
1742	68 9/16	1576	62 1/16
1809	71 1/4	1643	64 5/8
1876	73 7/8	1710	67 5/16
1943	76 1/2	1777	69 15/16
2010	79 1/8	1844	72 5/8
2077	81 3/4	1911	75 1/4
2144	84 7/16	1978	77 7/8
2211	87 1/16	2045	80 1/2
2278	89 11/16	2112	83 1/8
2345	92 5/16	2179	85 3/4
2412	94 15/16	2246	88 7/16
2479	97 5/8	2313	91 1/16
2546	100 1/4	2380	93 11/16
2613	102 7/8	2447	96 5/16
2680	105 1/2	2514	99

TANDEM VENEERS - MODULAR DESIGN

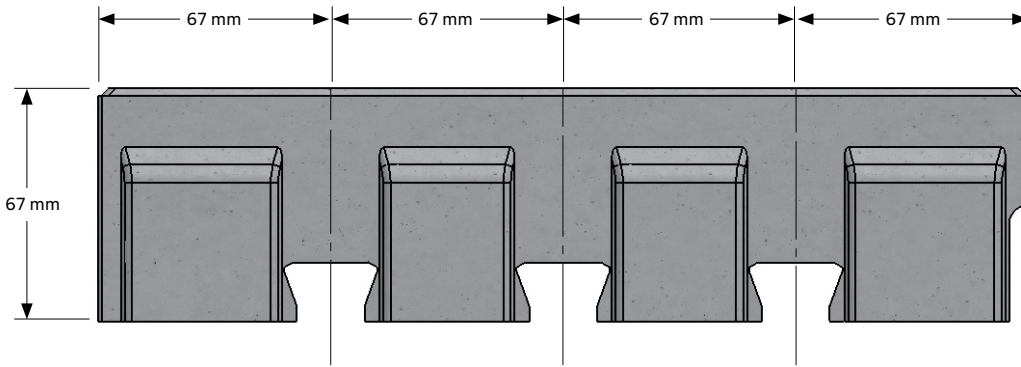

TYPICAL COMPONENT - PLAN VIEW

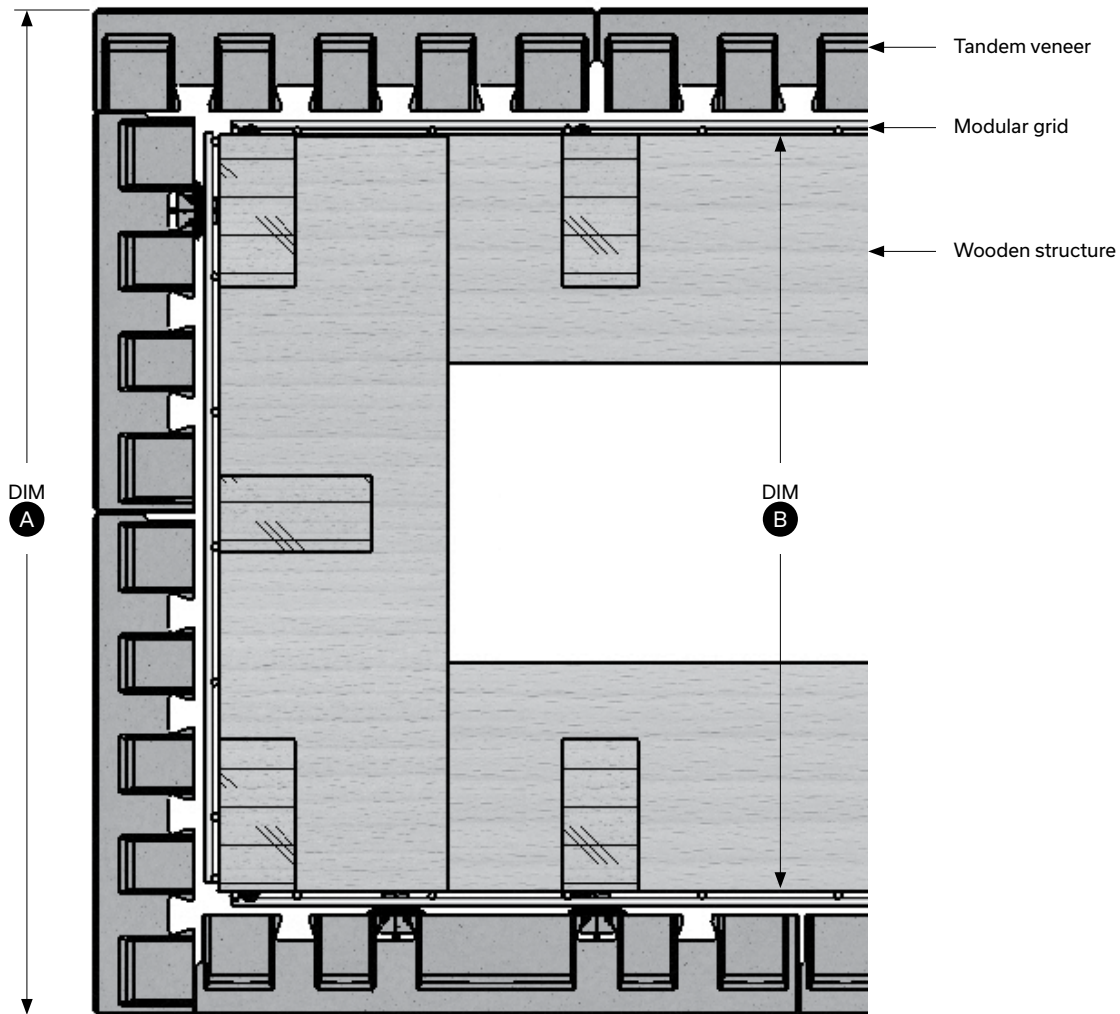

TYPICAL COMPONENT - SIDE VIEW

**HEIGHT OF COMPONENTS AND WOOD FRAME
ACCORDING TO THE MODULAR DESIGN
OF 90 mm VENEER UNITS**

NUMBER OF ROWS	HEIGHT (mm)	HEIGHT (in.)
2	180 mm	7 1/16
3	270 mm	10 5/8
4	360 mm	14 3/16
5	450 mm	17 11/16
6	540 mm	21 1/4
7	630 mm	24 13/16
8	720 mm	28 1/3
9	810 mm	31 1/8
10	900 mm	34 5/8
11	990 mm	39
12	1080 mm	42 1/2

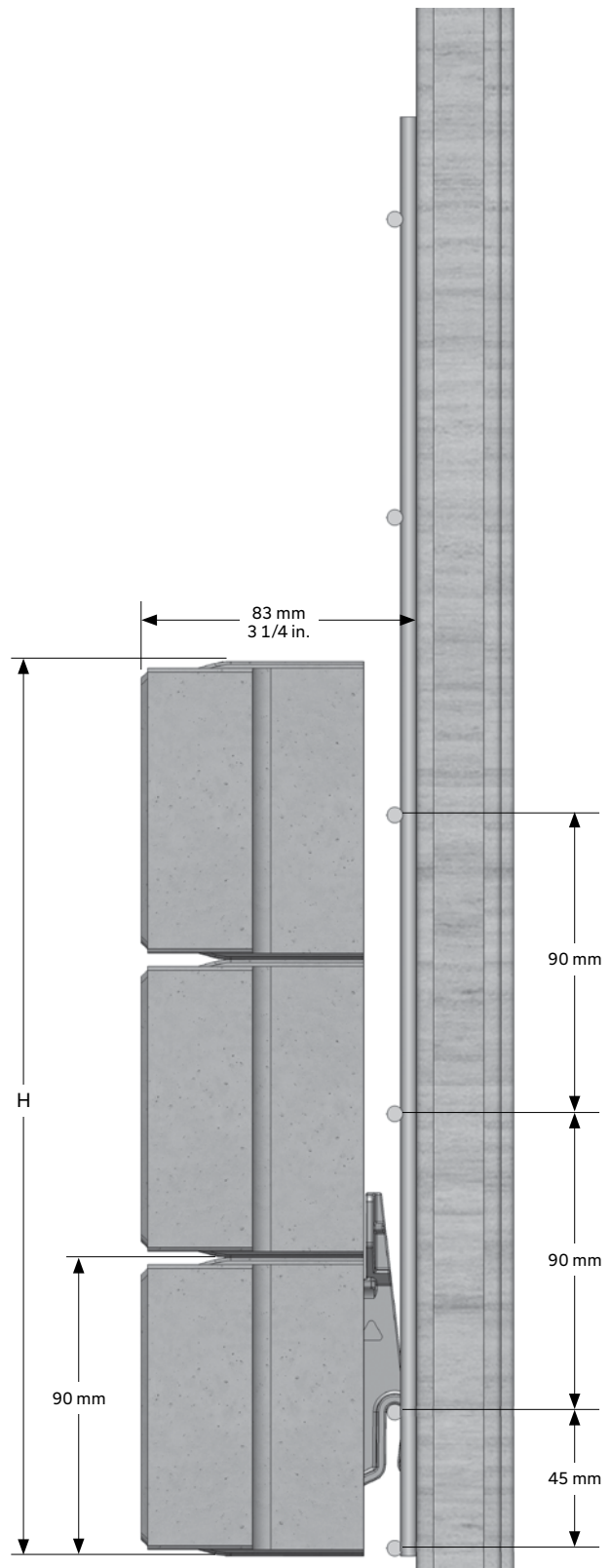

TYPICAL COMPONENT - FRONT VIEW

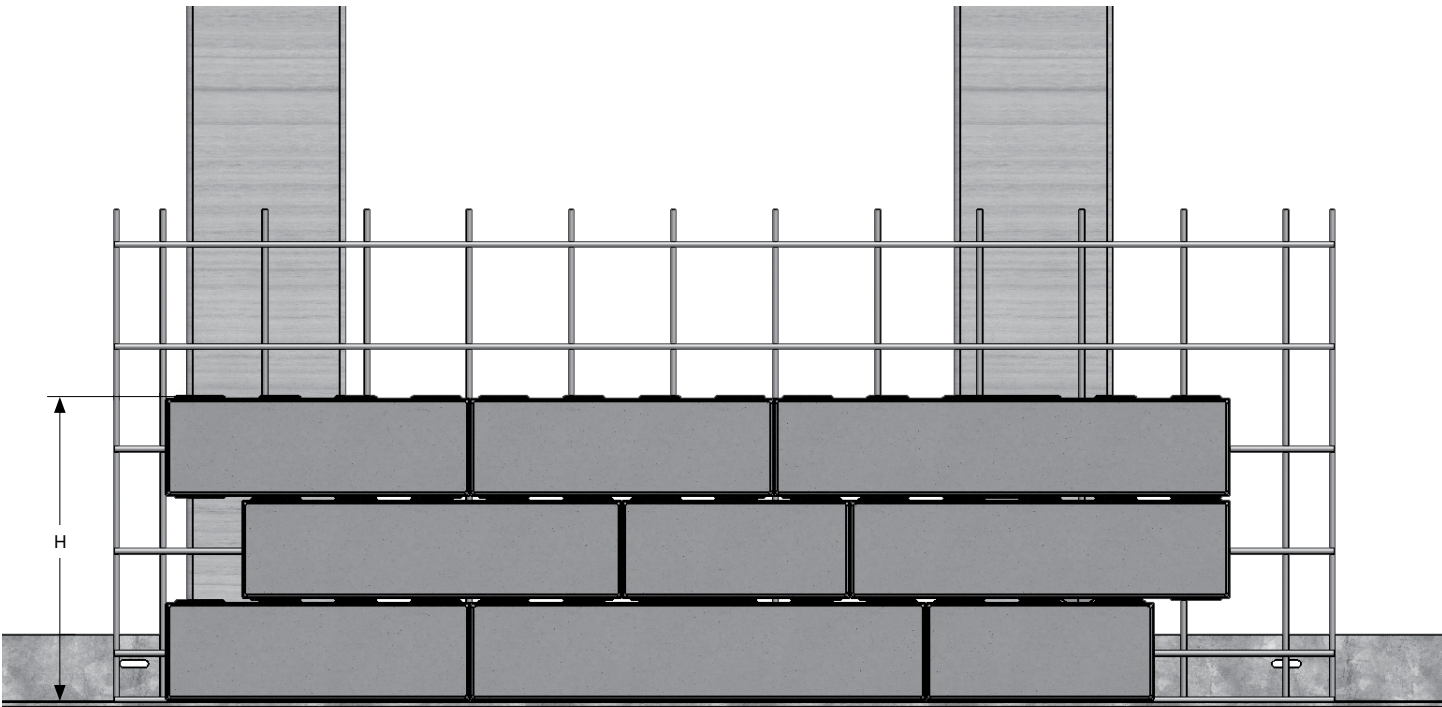

TANDEM MODULAR GRID - DETAIL 1

It is important to note that the units to be constructed must always be straight and have corners (inner and outer) forming a 90° angle. Therefore, making a corner is a common element in all construction plans. You can also refer to the plan view detail (page 44) to see how to make a 90° corner, taking into account the modular design of Tandem veneers and grids. When building the wood frame, keep in mind that you have to install Tandem grids. The flexibility of the grid means that you can install it in either direction, horizontally or vertically.

You have to cut the grids when the unit you're building is smaller in size (height or length) than a complete grid of 28 in. or 42 1/2 in. It may be helpful to decide the direction of the grid so as to minimize cuts. To cut a grid, use any suitable tool like a grinder or bolt cutters.

To avoid making cuts in the veneers, simply follow the dimensions based on the modular design of the veneers shown in the previous tables.

DETAIL 1

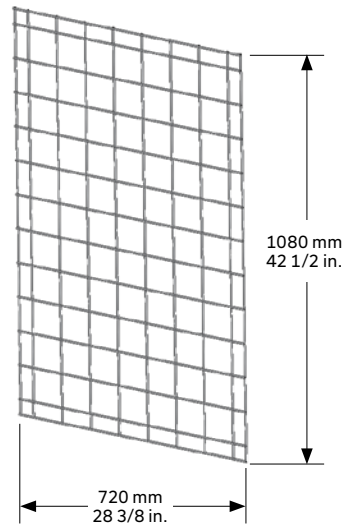

VERTICAL INSTALLATION

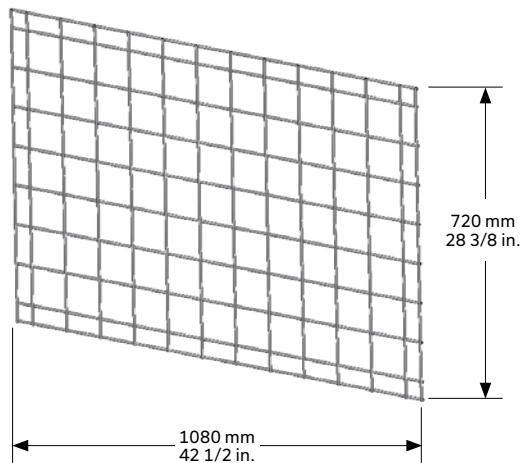

HORIZONTAL INSTALLATION

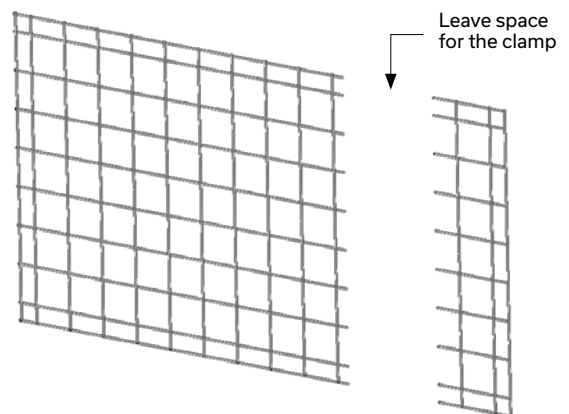

TANDEM MODULAR GRID - DETAIL 2

The grid is attached with the loop clamps and screws supplied. Simply place the loop clamps around the vertical rods of the grid and then insert a screw into the wood frame. There are 10 loop clamps per Tandem grid.

To secure a grid, the loop clamps should be evenly positioned, starting with the edge of the grid and moving towards the center. To ensure the solidity of the grid, use approximately one fastener (screw and loop clamps) per square foot of grid or 10 fasteners per square meter. To attach a grid to the wood frame, the vertical rods must be placed directly against the structure.

Since the metal rods of the grids are spaced every 90 mm, it's helpful if the intermediate posts of the wood framing are multiples of 90 mm. This will increase the available attachment area for the grid. A continuous attachment area like plywood sheeting can also be used to provide a larger surface for attaching the Tandem grid.

When a unit requires more than one grid either horizontally or vertically, they should be installed one after the other in both directions.

DETAIL 2

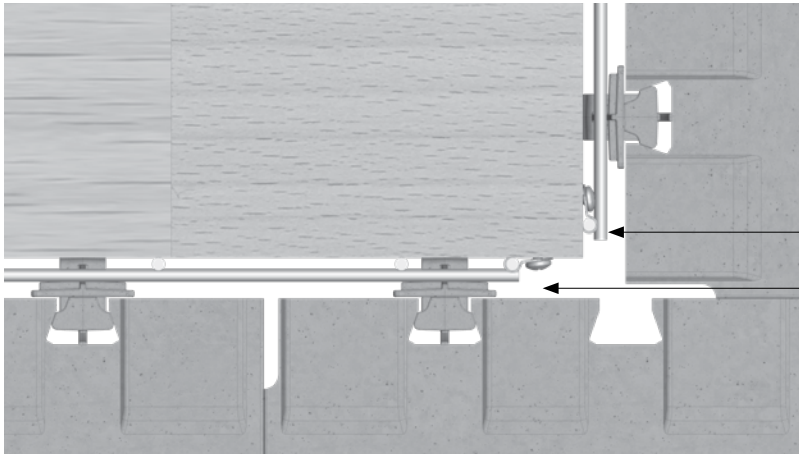

Keep the last vertical rod intact for better fixation
Leave free space to attach the loop clamps

MODULAR GRID CUTTING INSTRUCTIONS (PLAN VIEW)



ISOMETRIC VIEW

TANDEM VENEERS

When the grids have been installed, just insert the veneers into the unit using the connectors specially designed for this purpose. We recommend using 2 connectors per veneer for a solid job, but sometimes a connector cannot be inserted due to the geometry of the grid. You must then secure the veneer by gluing it to surrounding veneers with Techniseal concrete adhesive.

Normally, for a standard project, all formats of the veneer units are used randomly. As for retaining walls, always keep in mind the principle of staggering the vertical joints from one row to another. For the corners, you need corner units just like constructing a pillar with steel grids (see BUILDING PILLARS section). But it should be noted that sometimes the construction of a short unit requires a larger quantity of the same format veneers, especially corner units (for Lafitt Tandem, the amount of veneer corner units is in a proportion of about 1/2 of a pallet. For Melville Tandem, all veneer units have a textured corner. It is important to check this when calculating the quantity so as to have enough of the appropriate veneers on hand.

It is also possible to use 180 mm veneers when constructing a unit, the same as for a retaining wall or a column.

Stacking position on pallets (with a textured end)

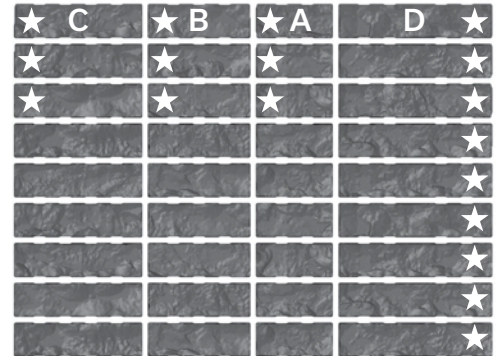

LAFITT TANDEM - UNITS 90

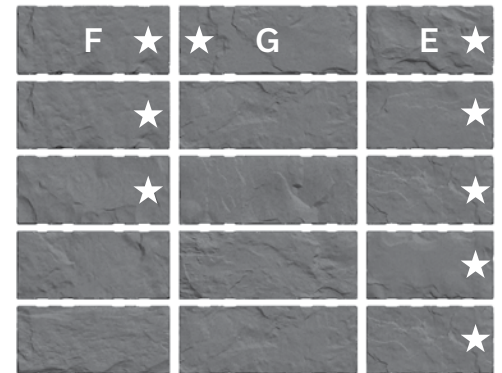

LAFITT TANDEM - UNITS 180

BRACING

Some items require bracing panels like plywood sheeting, especially for privacy walls, fencing and deck skirting. These panels are needed to strengthen the unit to withstand stress such as wind and to limit distortion under regular loads.

EXAMPLE OF BRACING (privacy wall)

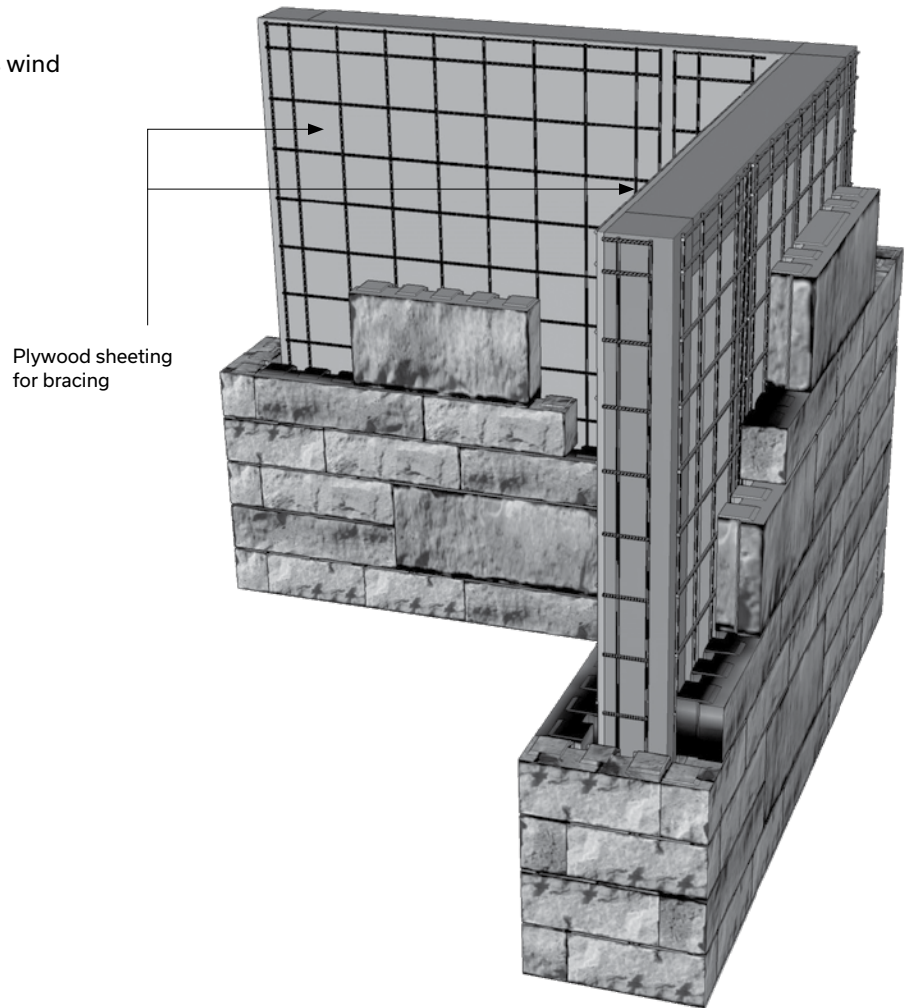

Other units require the installation of fiber cement panels for heat insulation (barbecues and outdoor gas fireplaces) or as protection against moisture (flower boxes). In these situations, we recommend fiber cement panels of a minimum thickness of 12 mm - 1/2 in.

EXAMPLE OF A HEAT PROTECTION SET-UP

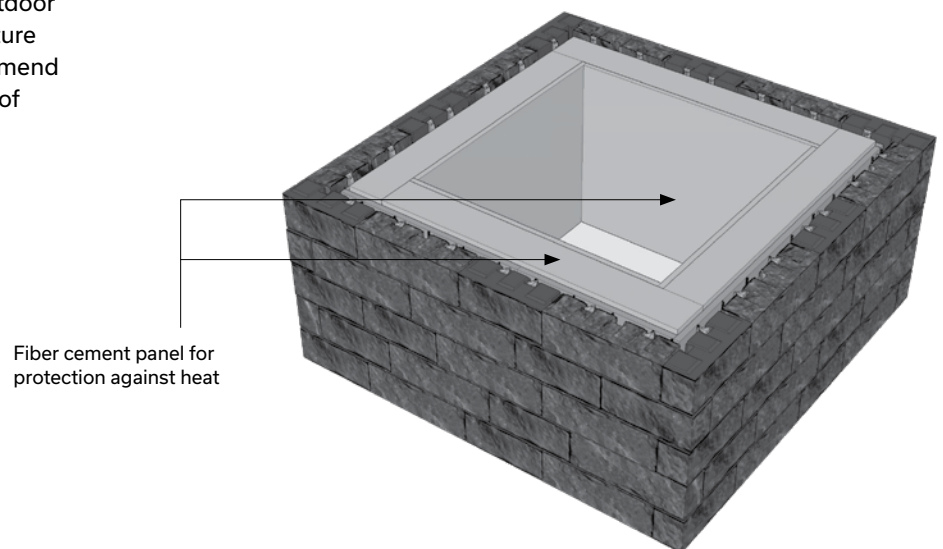

BASE SUPPORT FOR OUTDOOR UNITS

Outdoor units like a bench, flower box or outdoor fireplace can usually be built on a base of concrete foundation (starter units) or placed directly onto concrete pavers. A granular base of compacted crushed stone should be laid before the foundation. However, we recommend that long or heavy units be supported on a concrete slab (minimum thickness of 150 mm or 6 in. We also recommend that units like barbecues or tables with a single granite, quartz or marble top over their entire surface be supported on a reinforced concrete slab to prevent the top from breaking if the ground shifts. In each case, a compacted granular base should underlie the concrete slab.

CROSS SECTION - COMPONENTS SUPPORTED ON A CONCRETE SLAB

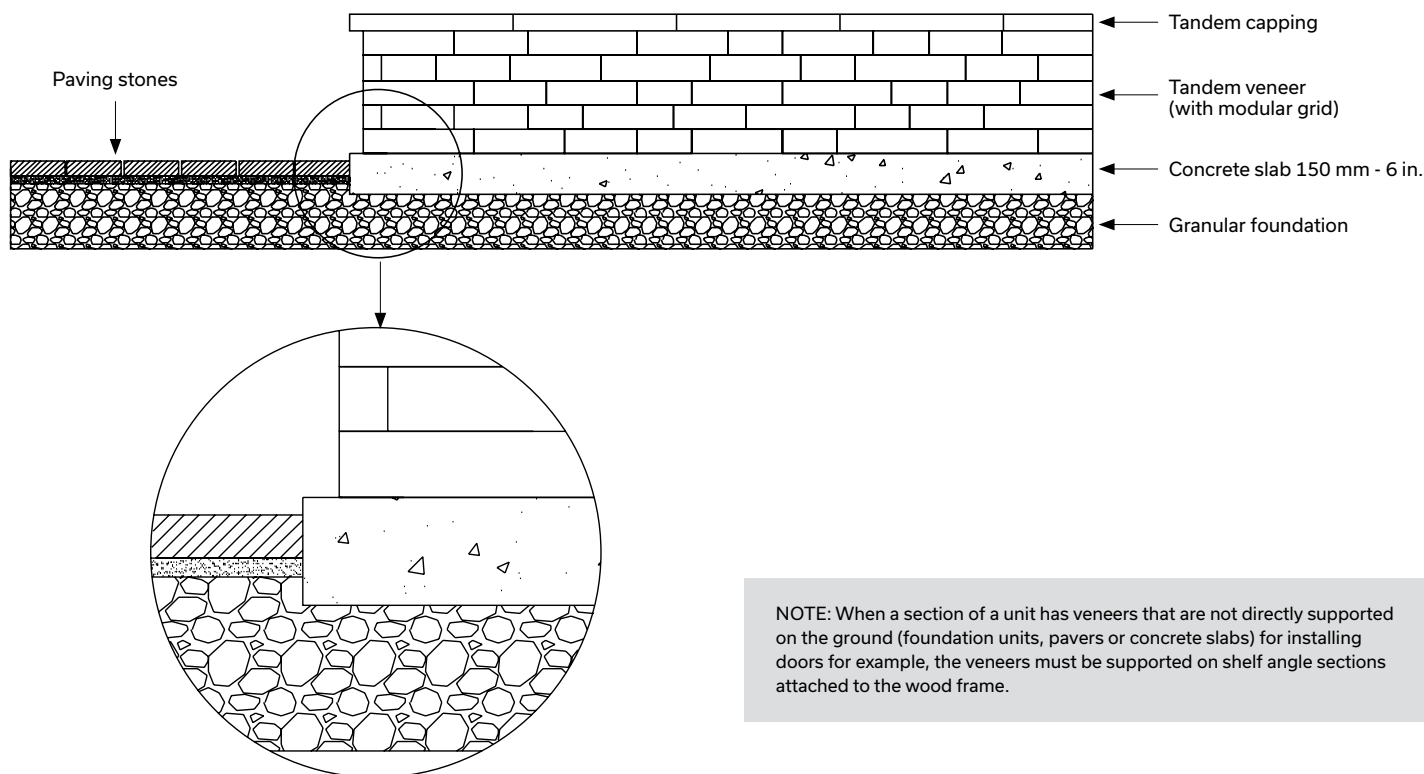

NOTE: When a section of a unit has veneers that are not directly supported on the ground (foundation units, pavers or concrete slabs) for installing doors for example, the veneers must be supported on shelf angle sections attached to the wood frame.

CONSTRUCTION LUMBER

Building the different units in this guide requires construction lumber for the framing: 2 x 4, 2 x 6 and 2 x 8 boards, 4 x 4 and 6 x 6 posts and plywood sheets. We recommend that all wood used outdoors be treated against rot according to established procedures approved by Health Canada. You should use S-P-F #1 or #2 wood or better. This type of wood usually has a minimum life of 15 years without maintenance in normal outdoor conditions.

NOTE: Wooden components that have been cut or sawed should be treated with an anti-rot product.

COMPLIANCE WITH CONSTRUCTION STANDARDS

In all circumstances, units to be constructed must always comply with the requirements of the National Building Code (version specific to your region) and local municipal bylaws and regulations.

Building an Outdoor Gas Fireplace

CONSTRUCTION OF AN OUTDOOR GAS FIREPLACE

Note that the only type of fireplace recommended for this type of construction is a propane gas or natural gas fireplace. A wood fireplace is not permitted.

Construction should begin with laying a solid foundation that is leveled, compacted and well drained.

The wood framing must be built according to the type of fireplace chosen. Dimensions are calculated using the data on shop drawings provided by the fireplace manufacturer. It may be necessary to add some extra parts like plywood shims for adjusting to the exact modular dimensions of the fireplace (Tandem modular veneers according to the wood frame design).

It is essential to install heat insulation. A fiber cement panel of a minimum thickness of 12 mm - 1/2 in. is recommended for adequate protection. The panels must be installed all around the heating element (burner).

You must also plan to install conduits in the ground for gas pipes and for electric cables if required.

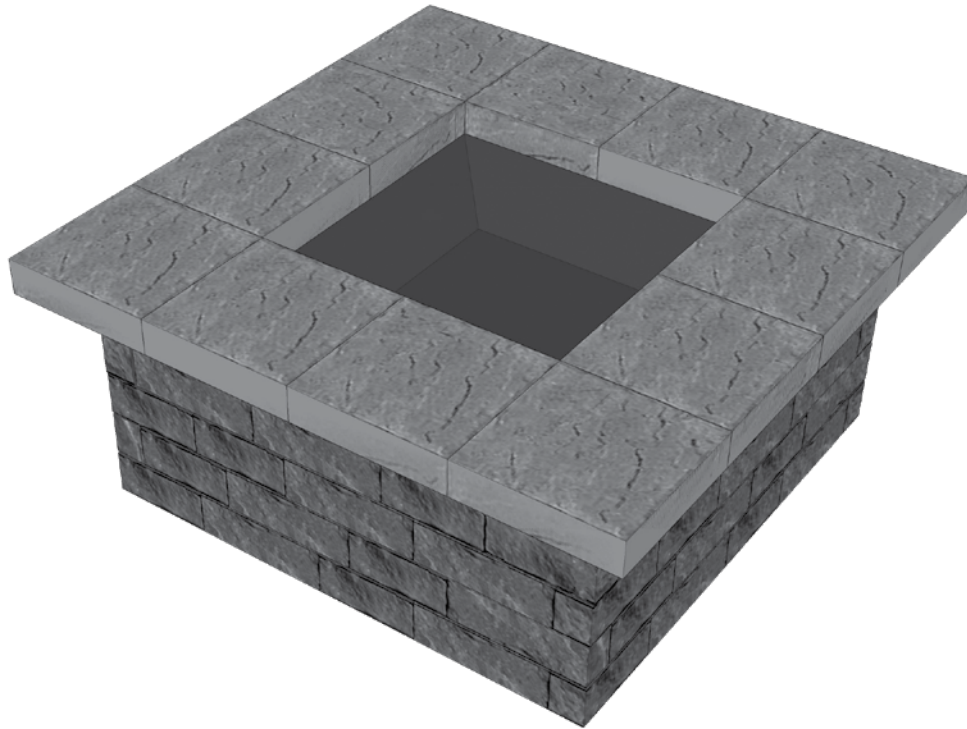

Building an Outdoor Kitchen

BUILDING AN OUTDOOR KITCHEN - BARBECUE, REFRIGERATOR, BAR

The wood frame must be constructed according to the type of barbecue chosen. Dimensions are calculated using data on the shop drawings provided by the barbecue manufacturer. Additional accessories such as a fridge or integrated cabinet doors are also possible. Naturally, you have to plan on adding pieces of wood to attach accessories to the wooden structure, like a frame in the case of doors. When purchasing supplies, you will usually find moldings to finish the edges of the various units.

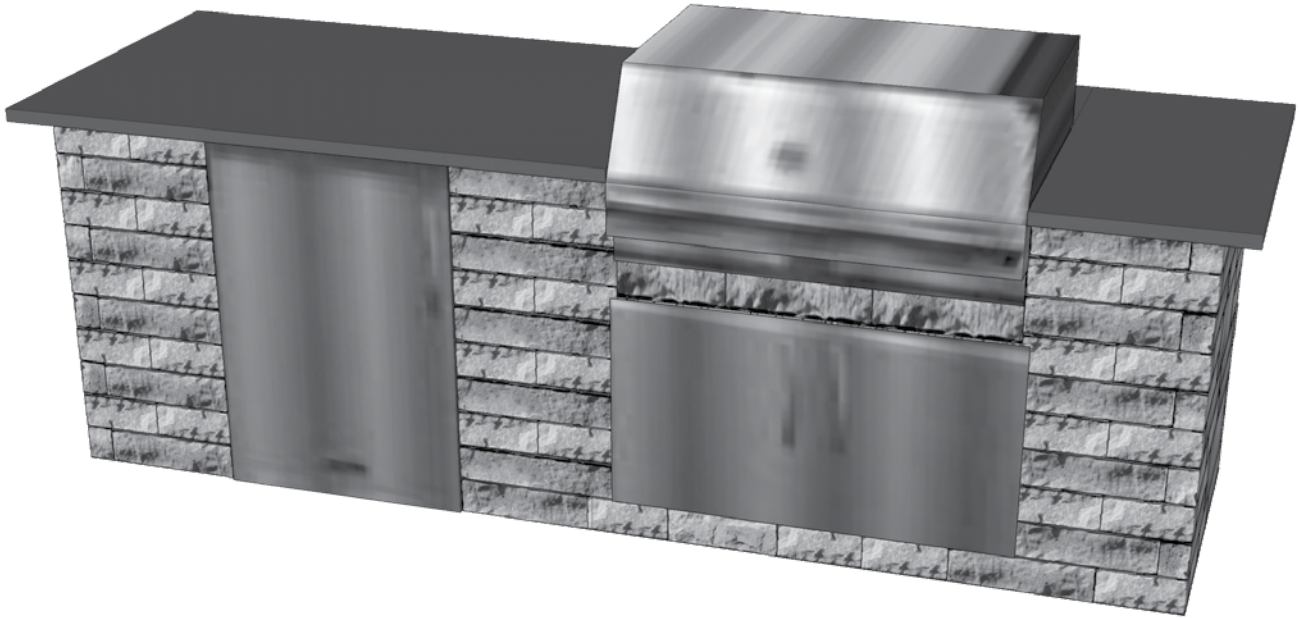

It is essential to install protection from heat and sparks. A fiber cement panel of a minimum thickness of 12 mm - 1/2 in. or a double-skinned steel section if provided by the BBQ manufacturer is recommended for adequate protection. The panels must be installed all around the heating element (burner).

Finish off with concrete capping or panels of granite, quartz, marble or natural stone. The panels must be made to measure by specialized companies. You must make special provisions for handling and installation to avoid possible breakage. The panels are attached on top of the plywood with silicone adhesive to prevent movement.

Provide adequate means for venting gases when constructing the barbecue. (Refer to the barbecue manufacturer's recommendations for the position and size of the ventilation grid required).

You should also plan to install conduits for gas pipes and electric cables. The conduits may in certain cases be installed in the ground.

Building Patio Furniture

BUILDING PATIO FURNITURE (TABLE AND BENCH) AND FLOWER BOX

TABLE

You can make a table by building a Tandem unit (grid and veneers) to form the base and then adding a tabletop. The tabletop can be wood, granite, quartz, marble or natural stone.

Dimensions may vary. It is essential to leave a minimum space between the table edge and the base. At least 460 mm - 18 in. is needed for leg room.

Granite, quartz or marble tabletop: the tabletop must be attached to the veneers with a silicone adhesive. We recommend that a tabletop resting on a Tandem unit be made from a single piece to increase rigidity and stability. This allows you to avoid adding a metal fastener to secure the tabletop to the structure for increased stability and extra protection where necessary. For very large tabletops, it is recommended to install steel supports (angles) to better stabilize the whole unit. You should enquire from the tabletop supplier what are the optimal sizes and thicknesses for stability and security and to avoid possible breakage.

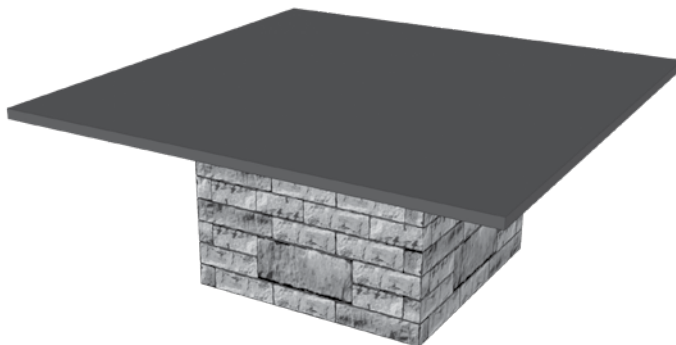

BENCH

You can make a bench by building a structure for the base and simply adding a concrete capping unit for the seat. Bench dimensions can vary, but it may be helpful to make your decision based on available capping units in order to avoid cuts. For a typical bench, the capping will be of the Melville Plus type.

Bench minimum width is 21 in.

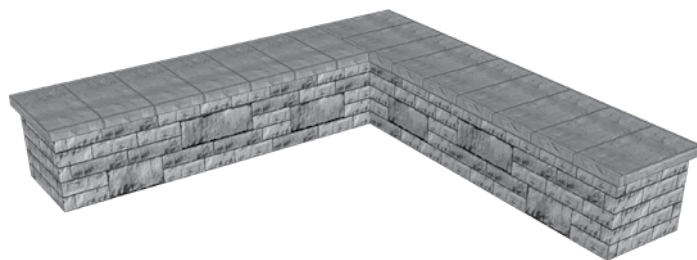

FLOWER BOX

It is recommended to install a fiber cement panel and a geotextile membrane to protect the wood against deterioration caused by vegetable and mineral materials (plants and soil). You should provide water drainage when building the structure.

For the capping, use the following products for retaining walls: Mondrian 50, Lafitt Plus Tandem, Melville Plus and Celtik capping.

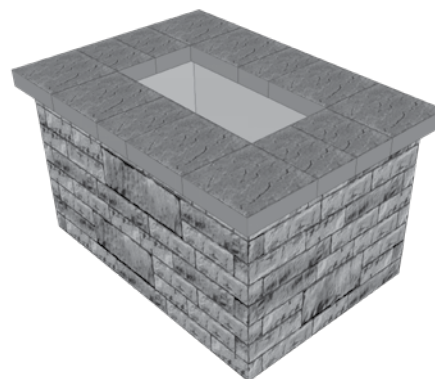

Building Privacy Walls and Fences

CONSTRUCTION OF A PRIVACY WALL AND A FENCE

When building a fence or when wanting to hide or conceal various pieces of equipment (e.g. pool filter, heat pump) or utility items (e.g. trashcans or storage bins), the Tandem modular grid system is just what you need.

Fencing is mostly built with treated wood posts (structural, select quality) supported by cast-in-place concrete foundations (Sonotubes) for the main structure. An intermediate structure in treated wood boards is then installed between the posts to attach the fence components of Tandem modular grids and veneers. A shelf angle is fixed to the base of the structure to provide continuous support for the weight of the veneers. The shelf angle (2 1/2 x 2 / 12 x 8 in.) is attached to the base of the structure (wood poles and boards forming the stringer) with suitable screws (#10 x 3 1/2 in.) every 200 mm - 8 in. The shelf angle can be cut to the size of the unit under construction.

The wooden structure between the posts, combined with the shelf angle, supports the weight of the walls and transfers it to the foundations. Fences and privacy walls must rest on pillars (Sonotubes) and concrete foundations to transfer the weight of the walls to the ground. The foundations are also necessary to prevent the walls from collapsing due to the force of the wind.

The dimensions of the foundations in this guide were calculated to respect the weight-bearing capacity of the soil and to limit irregular subsidence that could lead to distortions in the wall. Calculations were made for soil conditions of low weight-bearing

capacity. For different soil conditions, we recommend consulting a qualified engineer. The foundation must be built to withstand local frost conditions. The depth of frost in this guide is 1.8 m - 6 in. The use of screw piles is not recommended for this type of application.

Privacy walls are made with the same main structure to which a perpendicular section is added to obscure non-aesthetic items.

The maximum height of a fence or a privacy wall is limited to 1.8 m - 6 ft.

The maximum length of a wall facade between posts is 2.4 m - 8 ft.

The unit can be built to display its aesthetic appearance on one side or both sides simultaneously.

The wood frame must integrate a bracing panel such as a sheet of 12 mm - 1/2 in. treated plywood to provide a continuous attachment area and stabilize the structure to withstand loads. To finish the walls, attach a cap on top of the wood frame, either in concrete (sizes to be decided on site) or metal (custom bent by a specialized company). Tandem Melville Plus steps can be used to finish the top of a fence or privacy wall.

The capping unit is fixed with a suitable concrete adhesive spread on the wooden structure and the top of veneers. It may be useful to fix the wooden structure to the concrete cap with a metal attachment to provide additional wind protection.

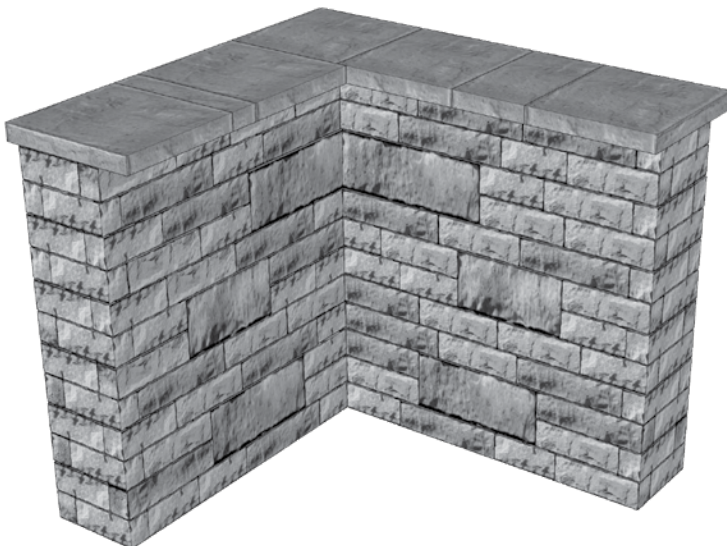

PRIVACY WALL

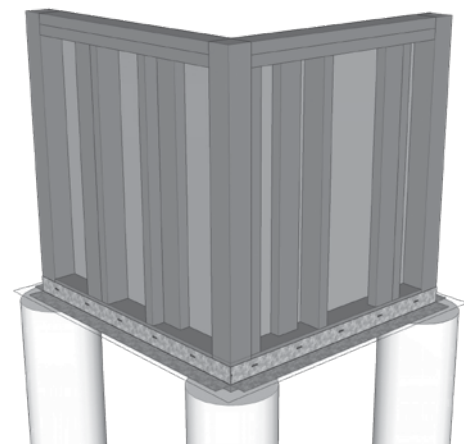

PRIVACY WALL on concrete pillar (Sonotube) - construction details of wooden structure

CONSTRUCTION OF OUTDOOR LIVING COMPONENTS WITH THE TANDEM MODULAR GRID

DESIGN DATA FOR FENCES

Since unit components will vary according to height from 0 to 1.8 m - 6 in., we present the main minimum requirements in table form.

FENCE WITH VENEER ON ONE SIDE					
FENCE HEIGHT	Ø PILASTER	FOOTING	EMBEDDING POST	POST	STRUCTURE
0 to 4 ft. OPTION 1	300 mm - 12 in.	Ø 600 mm - 24 in.	600 mm - 24 in.	4 x 4*	2 x 4
OPTION 2	300 mm - 12 in.	400 x 400 mm - 16 x 16 in.	600 mm - 24 in.	4 x 4*	2 x 4
OPTION 3	600 mm - 24 in.	N/A	600 mm - 24 in.	4 x 4*	2 x 4
4 to 5 ft. OPTION 1	300 mm - 12 in.	Ø 600 mm - 24 in.	600 mm - 24 in.	6 x 6**	2 x 6
OPTION 2	300 mm - 12 in.	400 x 400 mm - 16 x 16 in.	600 mm - 24 in.	6 x 6**	2 x 6
5 to 6 ft. OPTION 1	300 mm - 12 in.	Ø 600 mm - 24 in.	600 mm - 24 in.	6 x 6**	2 x 6
OPTION 2	300 mm - 12 in.	500 x 500 mm - 20 x 20 in.	600 mm - 24 in.	6 x 6**	2 x 6
FENCE WITH VENEER ON BOTH SIDES					
0 to 4 ft. OPTION 1	300 mm - 12 in.	Ø 600 mm - 24 in.	600 mm - 24 in.	4 x 4*	2 x 4
OPTION 2	300 mm - 12 in.	500 x 500 mm - 20 x 20 in.	600 mm - 24 in.	4 x 4*	2 x 4
4 to 5 ft. OPTION 1	300 mm - 12 in.	Ø 600 mm - 24 in.	600 mm - 24 in.	6 x 6**	2 x 6
OPTION 2	300 mm - 12 in.	500 x 500 mm - 20 x 20 in.	600 mm - 24 in.	6 x 6**	2 x 6
5 to 6 ft. OPTION 1	300 mm - 12 in.	Ø 600 mm - 24 in.	600 mm - 24 in.	6 x 6**	2 x 6
OPTION 2	300 mm - 12 in.	550 x 550 mm - 22 x 22 in.	600 mm - 24 in.	6 x 6**	2 x 6

N/A: Not Applicable * 4 x 4 SFP wood select structural ** 6 x 6 #1 SFP wood

It should be noted that the base of concrete pillars should normally have a wider section in the ground for a footing. The footing can take two shapes, square or round. There are round footings on the market, sold as BIGFOOT, which can be used for the construction of pillars. Square footings must be made on site with wooden formwork.

CONSTRUCTION OF OUTDOOR LIVING COMPONENTS WITH THE TANDEM MODULAR GRID

CAMOUFLAGE SCREEN DESIGN DATA

As the components of an element vary according to height (from 0 to 1.8 m - 6 ft.) we present in table form the main minimum criteria to consider.

WALL WITH VENEER ON ONE SIDE					
WALL HEIGHT	Ø PILASTER	FOOTING	EMBEDDING POST	POST	STRUCTURE
L1 and L2 configuration = 1.2 m - 4 ft.					
0 to 3 ft.	400 mm - 16 in.	N/A	600 mm - 24 in.	4 x 4*	2 x 4
3 to 6 ft. OPTION 1	600 mm - 24 in.	N/A	600 mm - 24 in.	6 x 6	2 x 6
OPTION 2	300 mm - 12 in.	400 x 400 mm - 16 x 16 in.	600 mm - 24 in.	6 x 6	2 x 6
OPTION 3	300 mm - 12 in.	Ø 600 mm - 24 in.	600 mm - 24 in.	6 x 6	2 x 6
L1 configuration = 2.4 m - 8 ft. and L2 = 1.2 m - 4 ft.					
0 to 4 ft. OPTION 1	600 mm - 24 in.	N/A	600 mm - 24 in.	4 x 4*	2 x 4
OPTION 2	300 mm - 12 in.	400 x 400 mm - 16 x 16 in.	600 mm - 24 in.	4 x 4*	2 x 4
4 to 5 ft. OPTION 1	600 mm - 24 in.	N/A	600 mm - 24 in.	6 x 6**	2 x 6
OPTION 2	300 mm - 12 in.	400 x 400 mm - 16 x 16 in.	600 mm - 24 in.	6 x 6**	2 x 6
OPTION 3	300 mm - 12 in.	Ø 600 mm - 24 in.	600 mm - 24 in.	6 x 6**	2 x 6
5 to 6 ft. OPTION 1	300 mm - 12 in.	400 x 400 mm - 16 x 16 in.	600 mm - 24 in.	6 x 6**	2 x 6
OPTION 2	300 mm - 12 in.	Ø 600 mm - 24 in.	600 mm - 24 in.	6 x 6**	2 x 6
WALL WITH VENEER ON BOTH SIDES					
L1 and L2 configuration = 1.2 m - 4 ft.					
0 to 4 ft.	400 mm - 16 in.	N/A	600 mm - 24 in.	4 x 4*	2 x 4
4 to 6 ft. OPTION 1	300 mm - 12 in.	400 x 400 mm - 16 x 16 in.	600 mm - 24 in.	6 x 6	2 x 6
OPTION 2	300 mm - 12 in.	400 x 400 mm - 16 x 16 in.	600 mm - 24 in.	6 x 6	2 x 6
L1 configuration = 2.4 m - 8 ft. and L2 = 1.2 m - 4 ft.					
0 to 3 ft. OPTION 1	600 mm - 24 in.	N/A	600 mm - 24 in.	4 x 4*	2 x 4
3 to 4 ft. OPTION 1	300 mm - 12 in.	400 x 400 mm - 16 x 16 in.	600 mm - 24 in.	4 x 4*	2 x 4
OPTION 2	300 mm - 12 in.	Ø 600 mm - 24 in.	600 mm - 24 in.	4 x 4*	2 x 4
4 to 6 ft. OPTION 1	300 mm - 12 in.	400 x 400 mm - 16 x 16 in.	600 mm - 24 in.	6 x 6**	2 x 6
OPTION 2	300 mm - 12 in.	Ø 600 mm - 24 in.	600 mm - 24 in.	6 x 6**	2 x 6

N/A: Not Applicable * 4 x 4 SFP wood select structural ** 6 x 6 #1 SFP wood

It should be noted that the base of concrete pillars should normally have a wider section in the ground for a footing. The footing can take two shapes, square or round. There are round footings on the market, sold as BIGFOOT, which can be used for the construction of pillars. Square footings must be made on site with wooden formwork.

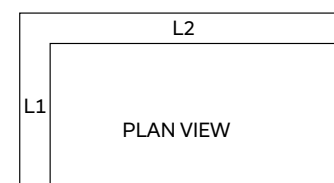

DESIGN ASSUMPTIONS

The construction of privacy walls or fences must take into account the following assumptions:

- > Wall weight (grid and veneers): 28 lbs/ft² (1.35 kN/m²)
- > Wind: 20 lbs/ft² (1 kPa)
- > Minimum allowable bearing capacity of soil: 1575 lbs/ft² (75 kPa)
- > Density of soil around pillars and foundations (γ): 18 kN/m³
- > Backfill must be compacted around Sonotubes and spread footings

- > Minimum depth of foundations: 6 ft (1.8 m} away from frost (consult an engineer to check the typical depth of frost for your area) It may be necessary to consult an engineer.

Leave a free space under the Tandem wall of at least 75 mm - 3 in. to ensure proper ventilation and adequate room for the potential effects of freezing and thawing.

NOTE: Design assumptions do not take into account earthquake effects. It may be necessary to consult an engineer.

PRIVACY WALL AND FENCE - TYPICAL FRONT VIEW

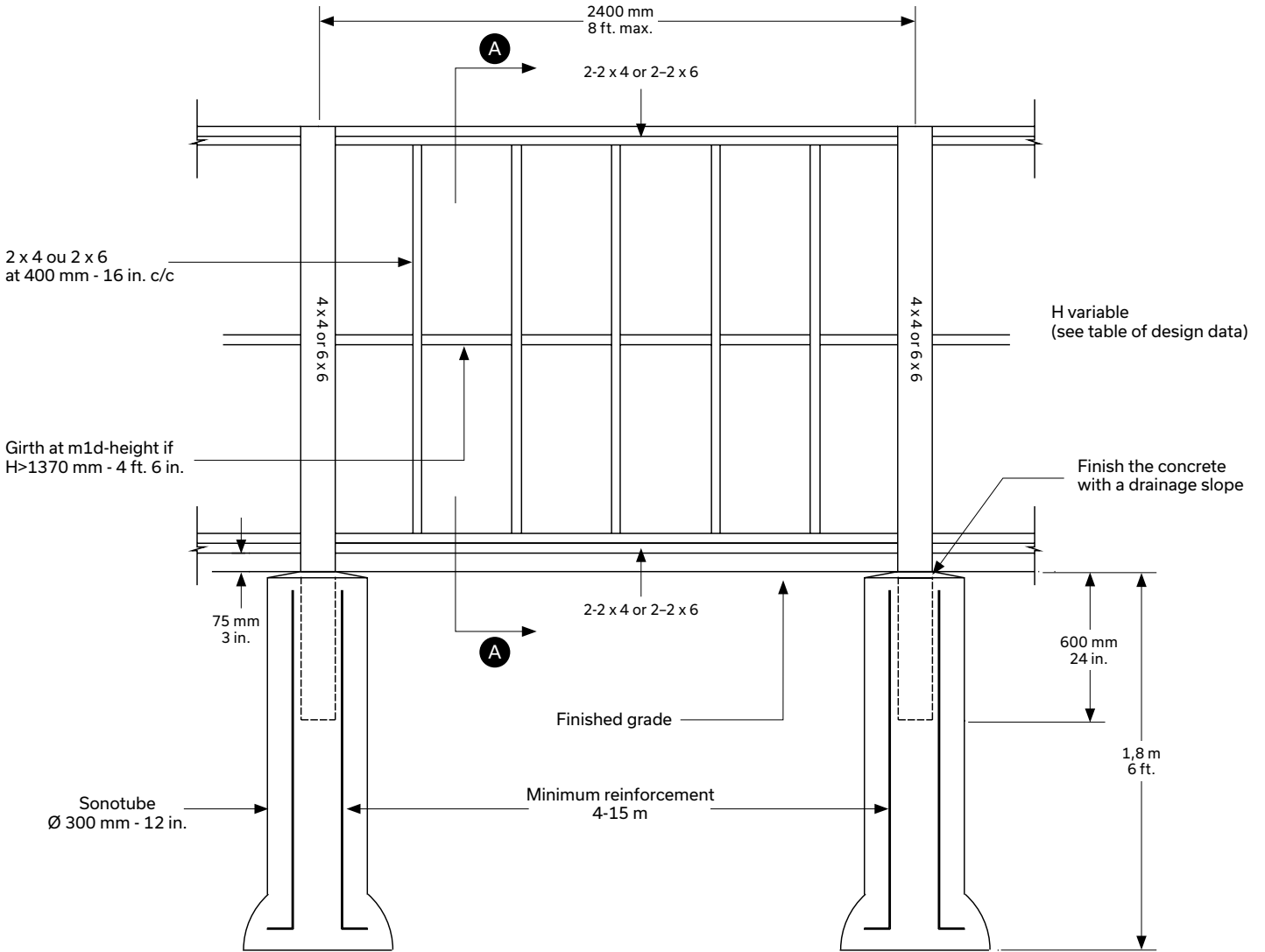

FOOTING
For different footing options, see the design data chart.

NOTE: The details shown here are only valid for the application suggested in this guide, taking into account the prescribed limitations. You are strongly recommended to engage a structural engineer or specialist in the field to validate structural design details for other configurations or for different soil conditions (lower or higher load capacity, presence of blocks, support on rock, etc.).

CROSS-SECTION - DOUBLE-SIDED WALL

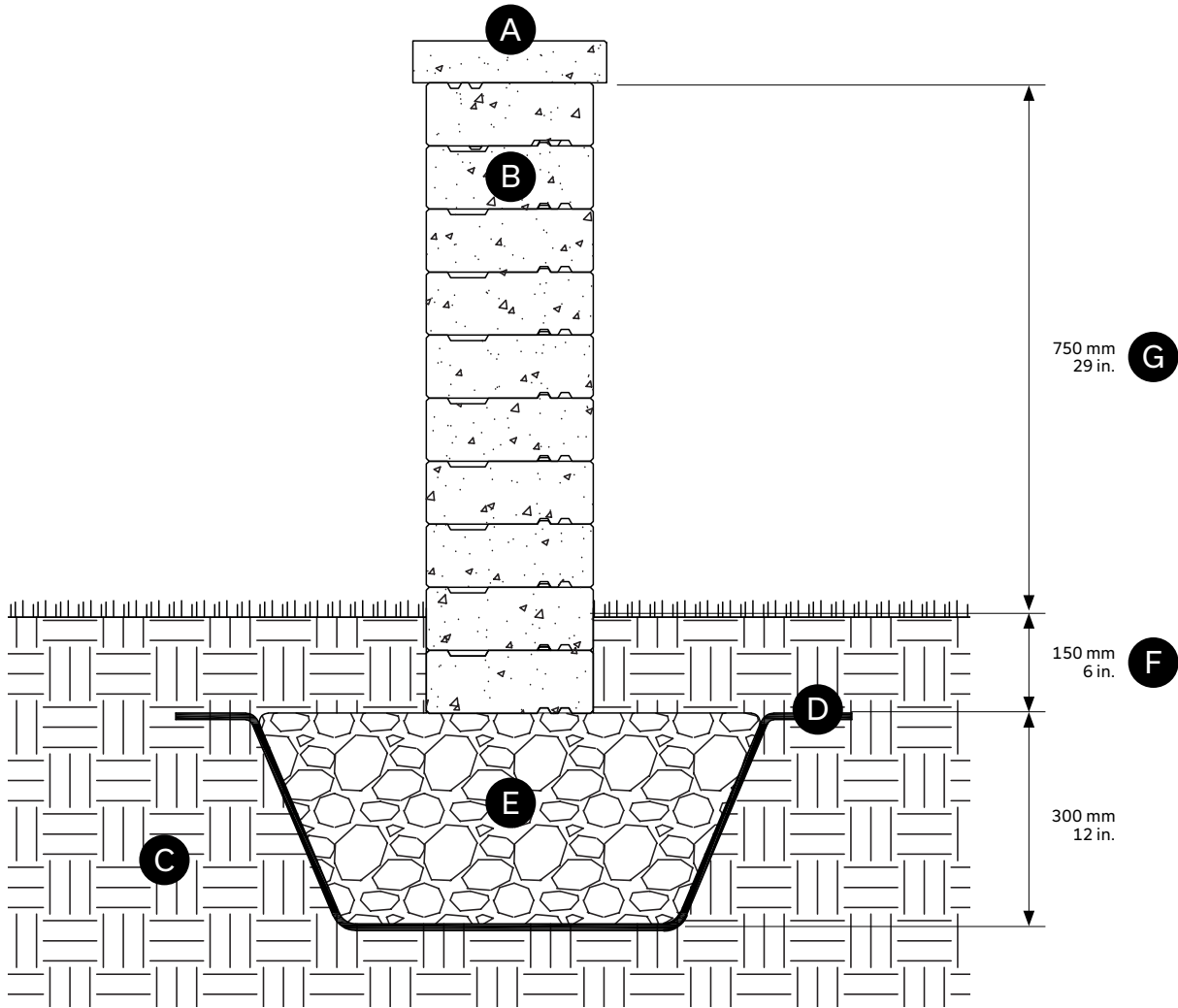

- Ⓐ Capping
- Ⓑ Vario Wall 90 mm
- Ⓒ Undisturbed soil
- Ⓓ Geotextile membrane
- Ⓔ Compacted granular foundation: 0 to 20 mm - 0 to 3/4 in.
Depth: 300 mm - 12 in. minimum
- Ⓕ Minimum buried depth 150 mm - 6 in.
- Ⓖ Maximum height without soil behind the wall, excluding the buried units and capping

CROSS-SECTION - CREATING VARIO WALL STEPS

To create steps, install the Melville Plus 90 step combined with the Vario wall units used as risers, as detailed below:

To complete the last row, turn the exposed unit upside down to have the tongues downward. Then, use Techniseal concrete adhesive to glue the step unit.

No accessory required for the Vario Wall. You don't have to use concrete adhesive between each row of the Vario Wall.

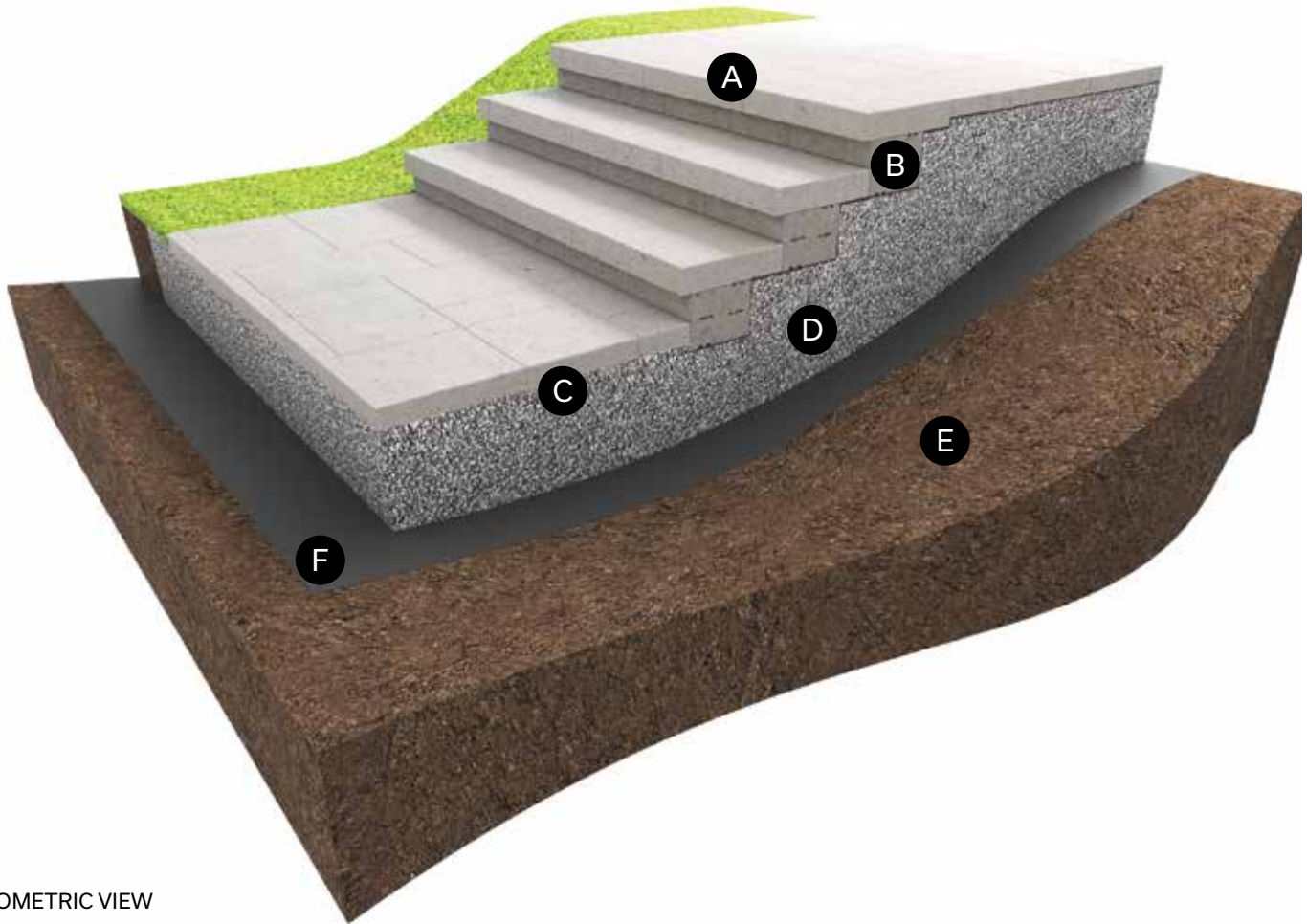

ISOMETRIC VIEW

- A** Melville Plus 90 Step
- B** Vario Wall 90 mm
- C** Laying bed: 25 mm - 1 in.
- D** Compacted granular foundation:
0 to 20 mm - 0 to 3/4 in.
Depth: 300 mm - 12 in. minimum
- E** Undisturbed soil
- F** Geotextile membrane

CROSS-SECTION - WALL STEP INSTALLATION

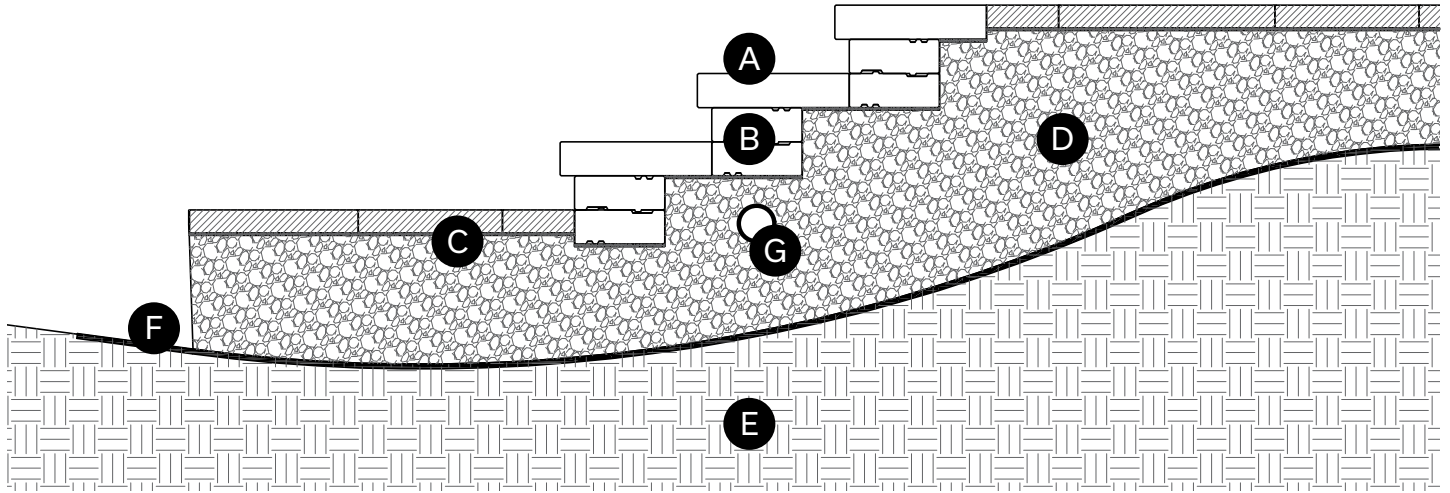

- Ⓐ Melville Plus 90 Step
- Ⓑ Vario Wall 90 mm
- Ⓒ Laying bed: 25 mm - 1 in.
- Ⓓ Compacted granular foundation:
0 to 20 mm - 0 to 3/4 in.
Depth: 300 mm - 12 in. minimum
- Ⓔ Undisturbed soil
- Ⓕ Geotextile membrane
- Ⓖ Perforated drain connected to services:
100 mm Ø - 4 in.

CROSS-SECTION - WALL STEP INSTALLATION

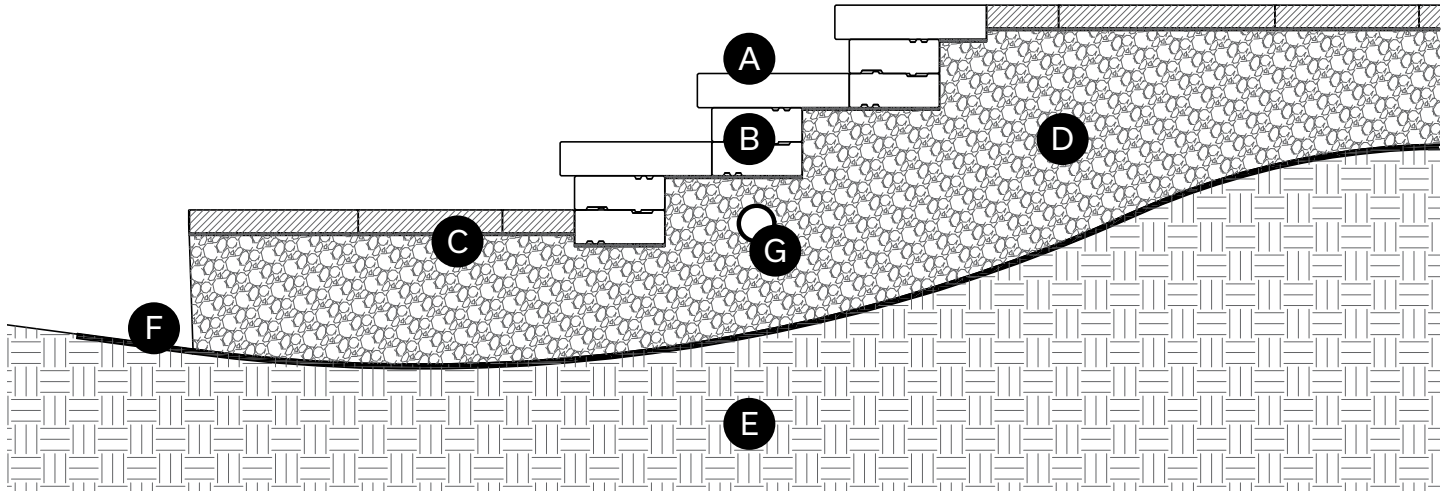

- Ⓐ Melville Plus 90 Step
- Ⓑ Vario Wall 90 mm
- Ⓒ Laying bed: 25 mm - 1 in.
- Ⓓ Compacted granular foundation:
0 to 20 mm - 0 to 3/4 in.
Depth: 300 mm - 12 in. minimum
- Ⓔ Undisturbed soil
- Ⓕ Geotextile membrane
- Ⓖ Perforated drain connected to services:
100 mm Ø - 4 in.

12 ROW SETBACK WALL - WITH SURCHARGE, NO SLOPE

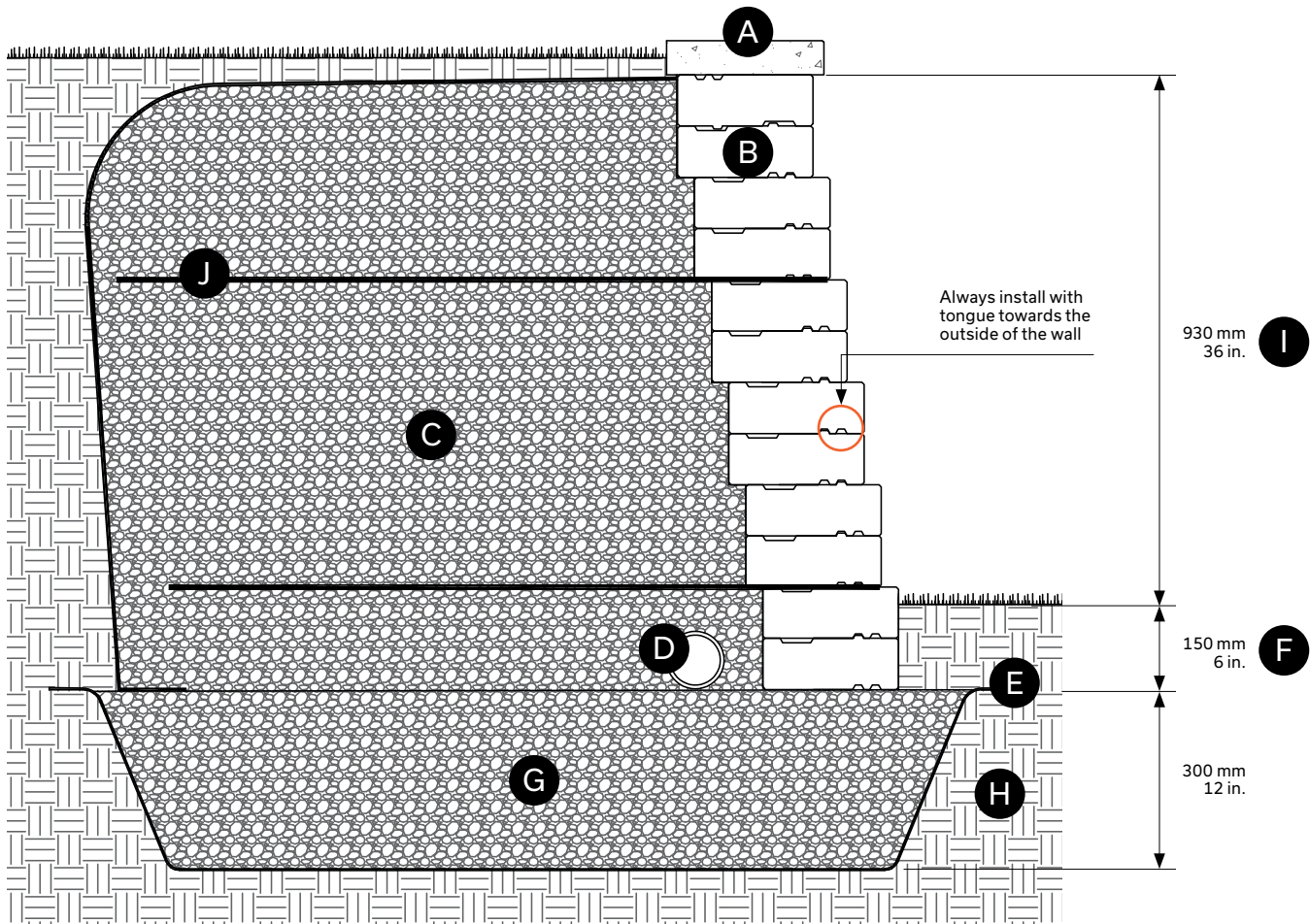

- A** Capping
- B** Vario Wall 90 mm (setback angle: 9.46 degrees, 150 mm)
- C** Clean stone 20 mm - 3/4 in. - Depth: 1400 mm - 55 in. min.
- D** Perforated drain connected to services: 100 mm Ø - 4 in.
- E** Geotextile membrane
- F** Minimum buried depth 150 mm - 6 in.
- G** Compacted granular foundation: 0 to 20 mm - 0 to 3/4 in. - Depth: 300 mm - 12 in. minimum
- H** Undisturbed soil
- I** Maximum height with surcharge and no slope behind the wall, excluding the buried units and capping
- J** Geogrid 1250 mm - 50 in.

18 ROW SETBACK WALL – WITH SURCHARGE, NO SLOPE

Vario Wall 90 mm installed with a setback and geogrid – 18 rows (total height of 1620 mm or 63 in.). With surcharge behind the wall (5kPa), no slope.

- > Install Vario Wall 90 mm units in pairs: create a 30 mm setback by following the tongue and groove system on every other row
- > Create the setback by installing the outer groove (female) on the tongue (male) at every other row
- > Always position the tongue on the outer side of the wall
- > Add a 1250 mm long geogrid (50 in.) over the Vario Wall unit. The geogrid is held by the tongue and groove system and the weight of the clean stone. Recommended geogrid: Miragrid 2XT
- > At the very last row, turn the unit upside down to have the tongue downward. Then, use Techniseal concrete adhesive to glue the Permacon capping of your choice.

No accessory required for the Vario Wall. You don't have to use concrete adhesive between each row of the Vario Wall.

Maximum gravity wall heights assume no slopes or surcharge behind the wall and that the wall retains sand or gravel ($\phi = 34$ degrees, $\gamma = 19$ kN/m³)²

18 ROW SETBACK WALL - WITH SURCHARGE, NO SLOPE

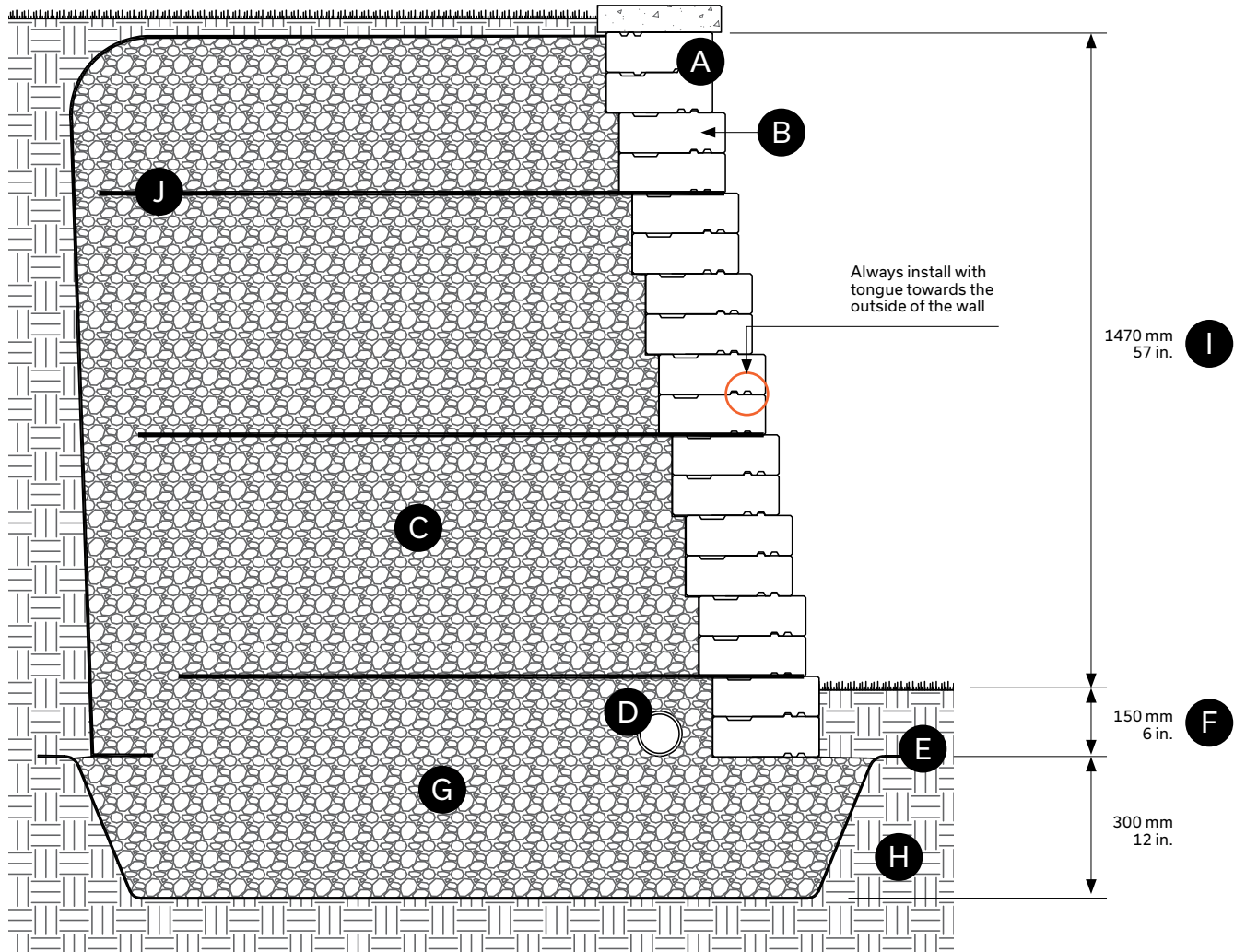

- (A) Capping
- (B) Vario Wall 90 mm (setback angle: 9.46 degrees, 240 mm)
- (C) Clean stone 20 mm - 3/4 in. - Depth: 1490 mm - 59 in. min.
- (D) Perforated drain connected to services: 100 mm Ø - 4 in.
- (E) Geotextile membrane
- (F) Minimum buried depth 150 mm - 6 in.
- (G) Compacted granular foundation: 0 to 20 mm - 0 to 3/4 in. - Depth: 300 mm - 12 in. minimum
- (H) Undisturbed soil
- (I) Maximum height with surcharge and no slope behind the wall, excluding the buried units and capping
- (J) Geogrid 1250 mm - 50 in.

24 ROW SETBACK WALL – WITH SURCHARGE, NO SLOPE

Vario Wall 90 mm installed with a setback and geogrid – 24 rows (total height of 2160 mm or 84 in.). With surcharge behind the wall (5kPa), no slope.

- > Install Vario Wall 90 mm units in pairs: create a 30 mm setback by following the tongue and groove system on every other row
- > Create the setback by installing the outer groove (female) on the tongue (male) at every other row
- > Always position the tongue on the outer side of the wall
- > Add a 1550 mm long geogrid (61 in.) over the Vario Wall unit. The geogrid is held by the tongue and groove system and the weight of the clean stone. Recommended geogrid: Miragrid 2XT
- > At the very last row, turn the unit upside down to have the tongue downward. Then, use Techniseal concrete adhesive to glue the Permacon capping of your choice.

No accessory required for the Vario Wall. You don't have to use concrete adhesive between each row of the Vario Wall.

Maximum gravity wall heights assume no slopes or surcharge behind the wall and that the wall retains sand or gravel ($\phi = 34$ degrees, $\gamma = 19$ kN/m³)²

24 ROW SETBACK WALL - WITH SURCHARGE, NO SLOPE

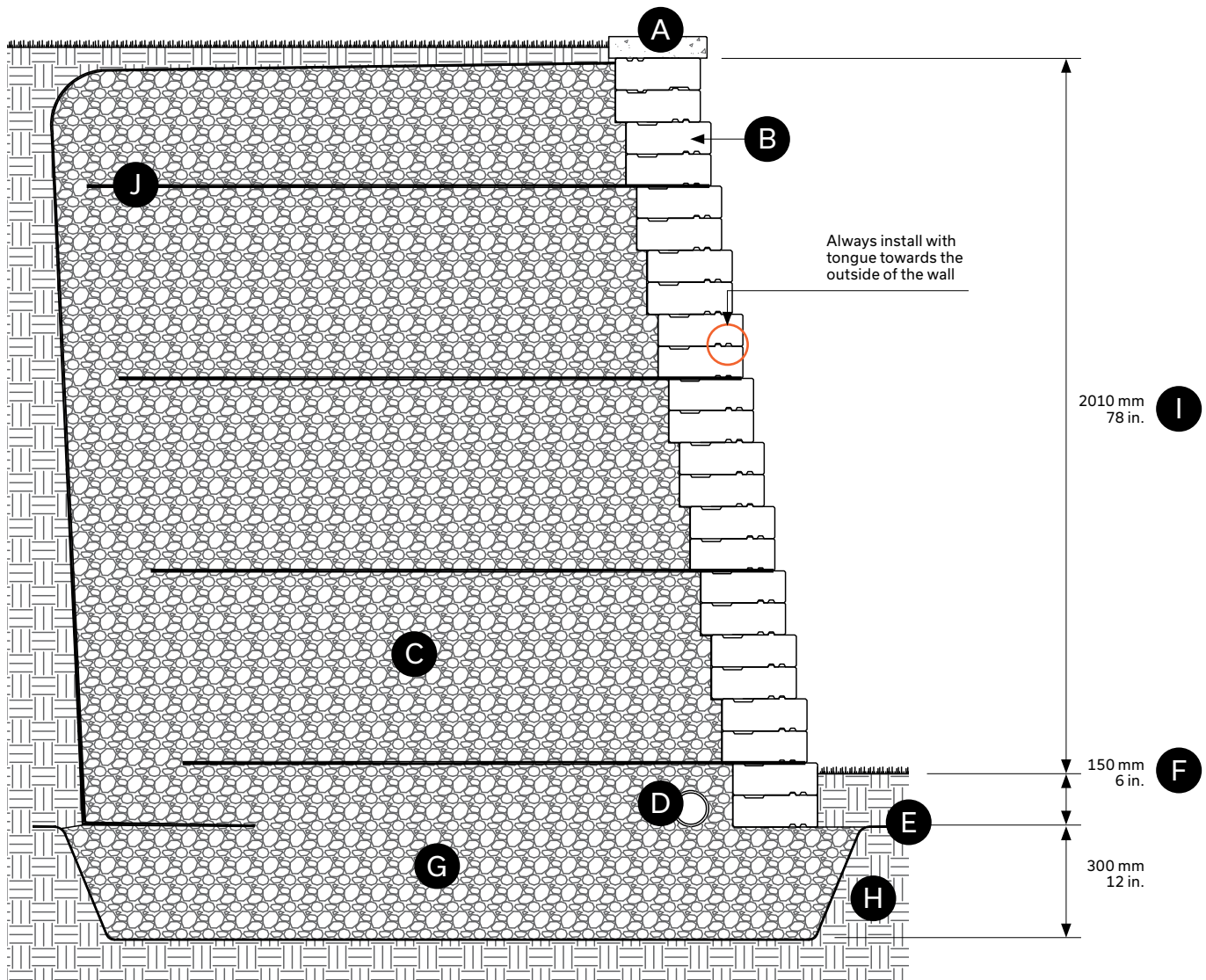

- A Capping
- B Vario Wall 90 mm (setback angle: 9.46 degrees, 330 mm)
- C Clean stone 20 mm - 3/4 in. - Depth: 1880 mm - 74 in. min.
- D Perforated drain connected to services: 100 mm Ø - 4 in.
- E Geotextile membrane
- F Minimum buried depth 150 mm - 6 in.
- G Compacted granular foundation: 0 to 20 mm - 0 to 3/4 in. - Depth: 300 mm - 12 in. minimum
- H Undisturbed soil
- I Maximum height with surcharge and no slope behind the wall, excluding the buried units and capping
- J Geogrid 1550 mm - 61 in.